

[54] TRAY TABLE

[75] Inventor: Charles R. Goetz, Carnegie, Pa.

[73] Assignee: Alco Industries, Inc., Valley Forge, Pa.

[**] Term: 14 Years

[21] Appl. No.: 943,164

[22] Filed: Dec. 17, 1986

[52] U.S. Cl. D6/484

[58] Field of Search D6/429, 449, 466-469, D6/473-476, 484; D7/7, 37; D34/40, 43

[56] References Cited

U.S. PATENT DOCUMENTS

D. 220,704	5/1971	Kramer	D6/484
D. 248,798	8/1978	Driscoll	D6/484
D. 281,555	12/1985	LEvy	D6/429 X
D. 286,479	11/1986	Marchesini	D6/484
D. 293,051	12/1987	Lemmeyer et al.	D6/484
D. 293,635	1/1988	Goetz	D6/449

Primary Examiner—Bruce W. Dunkins
Assistant Examiner—Janice Seeger
Attorney, Agent, or Firm—Webb, Burden, Ziesenheim & Webb

[57] CLAIM

The ornamental design for a tray table, as shown and described.

DESCRIPTION

FIG. 1 is a perspective view of a tray table, showing my new design;
 FIG. 2 is a top plan view;
 FIG. 3 is a side elevational view, the opposite side being identical thereto;
 FIG. 4 is a bottom plan view;
 FIG. 5 is an end elevational view, the opposite end being identical thereto;
 FIG. 6 is a top plan view of a tray table, showing a second embodiment of my new design;
 FIG. 7 is a side elevational view of the second embodiment, the opposite side being identical thereto;
 FIG. 8 is a bottom plan view of the second embodiment;
 FIG. 9 is an end elevational view of the second embodiment, the opposite end being identical thereto;
 FIG. 10 is a top plan view of a tray table, showing a third embodiment of my new design;
 FIG. 11 is a side elevational view of the third embodiment, the opposite side being identical thereto;
 FIG. 12 is a bottom plan view of the third embodiment; and
 FIG. 13 is an end elevational view of the third embodiment, the opposite end being identical thereto.

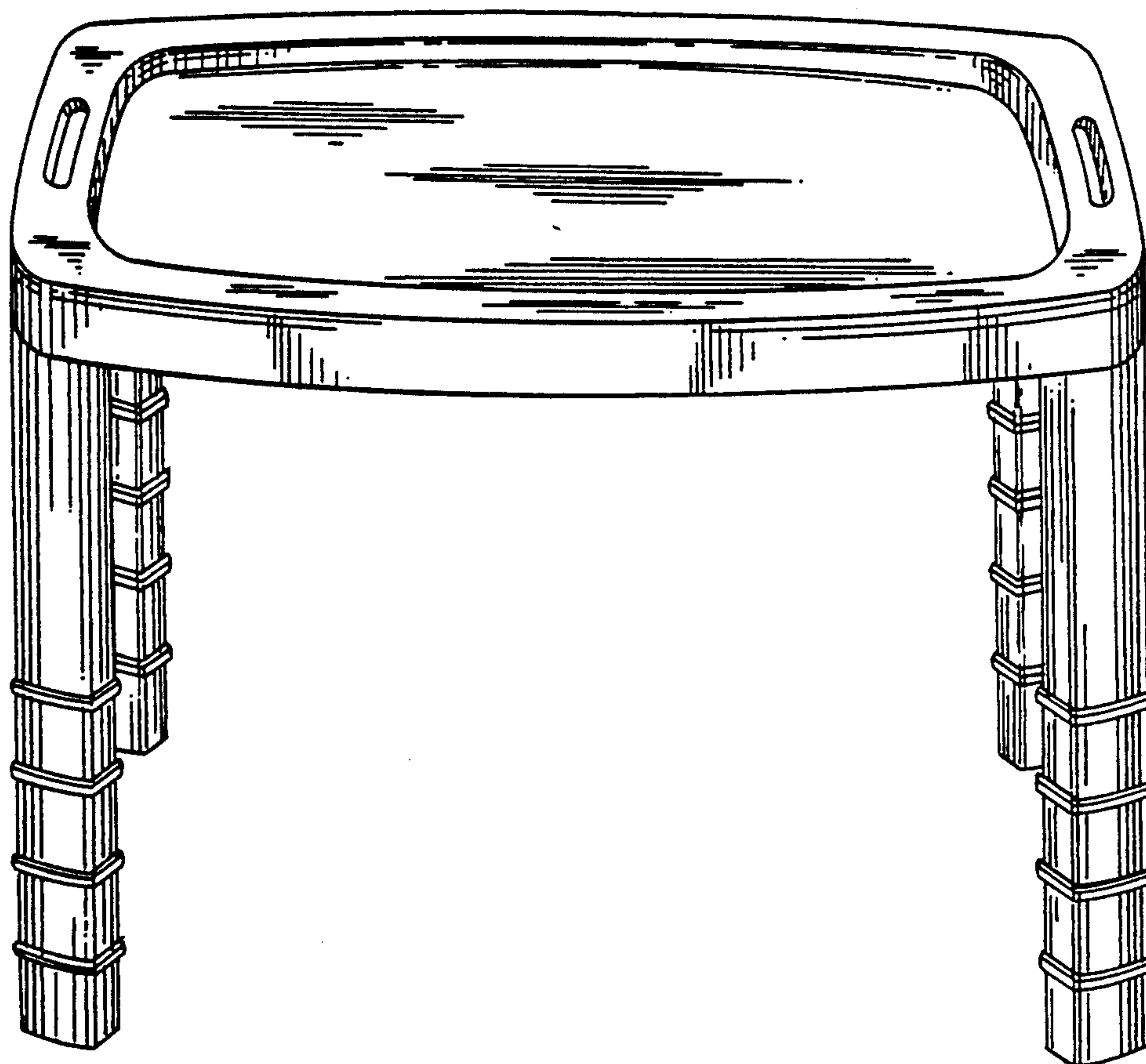

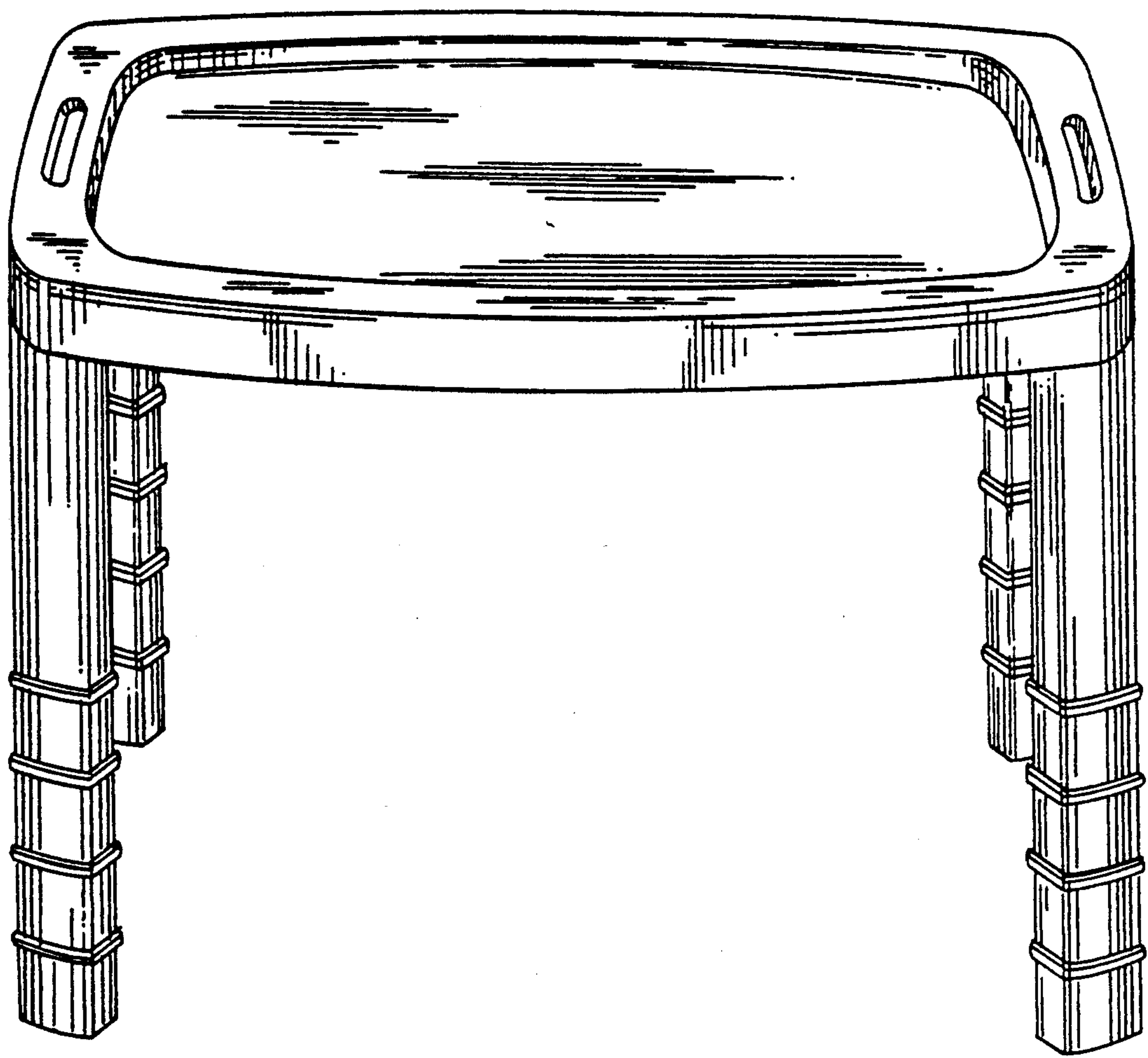

FIG. 1

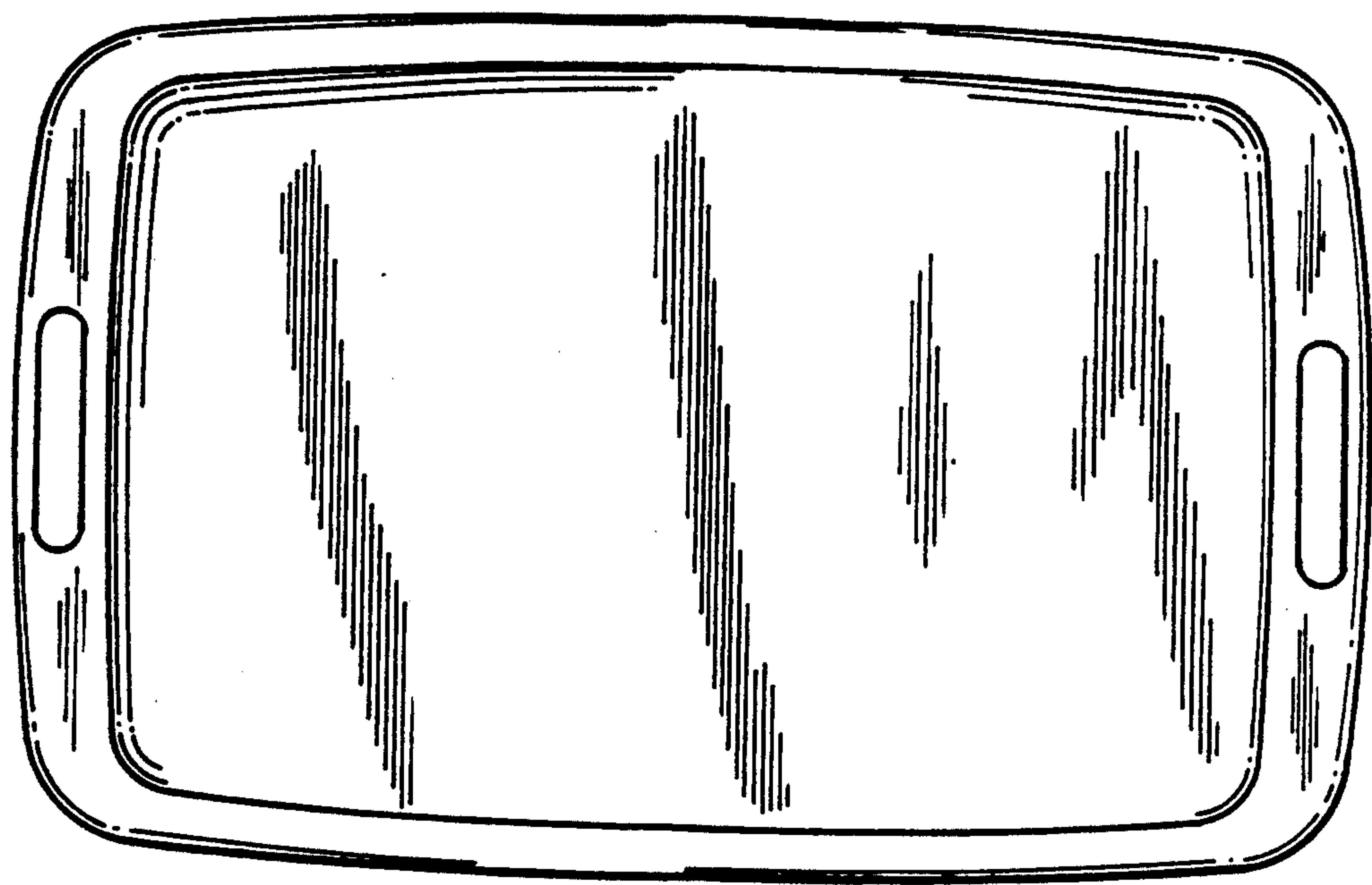

FIG. 2

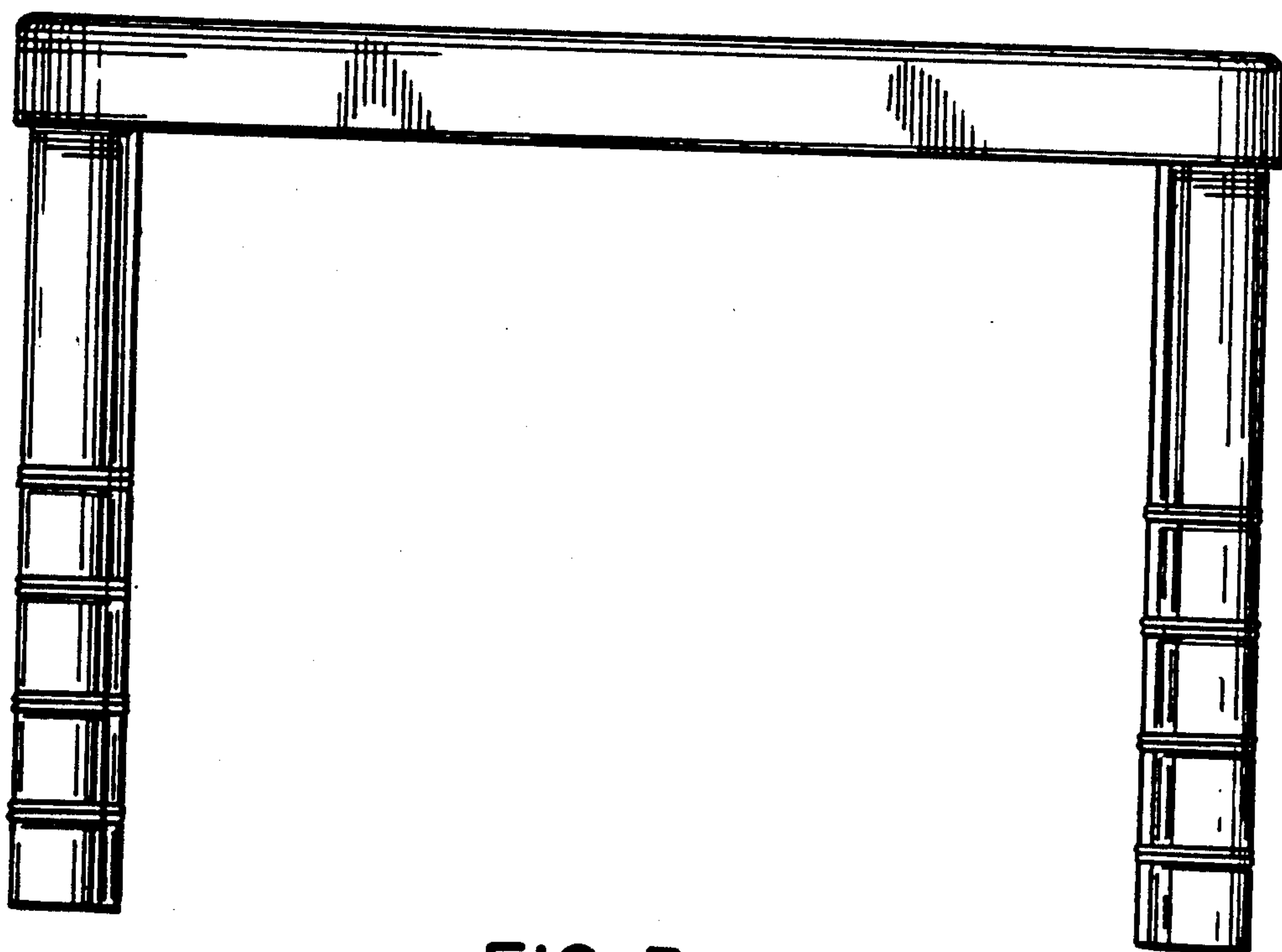

FIG. 3

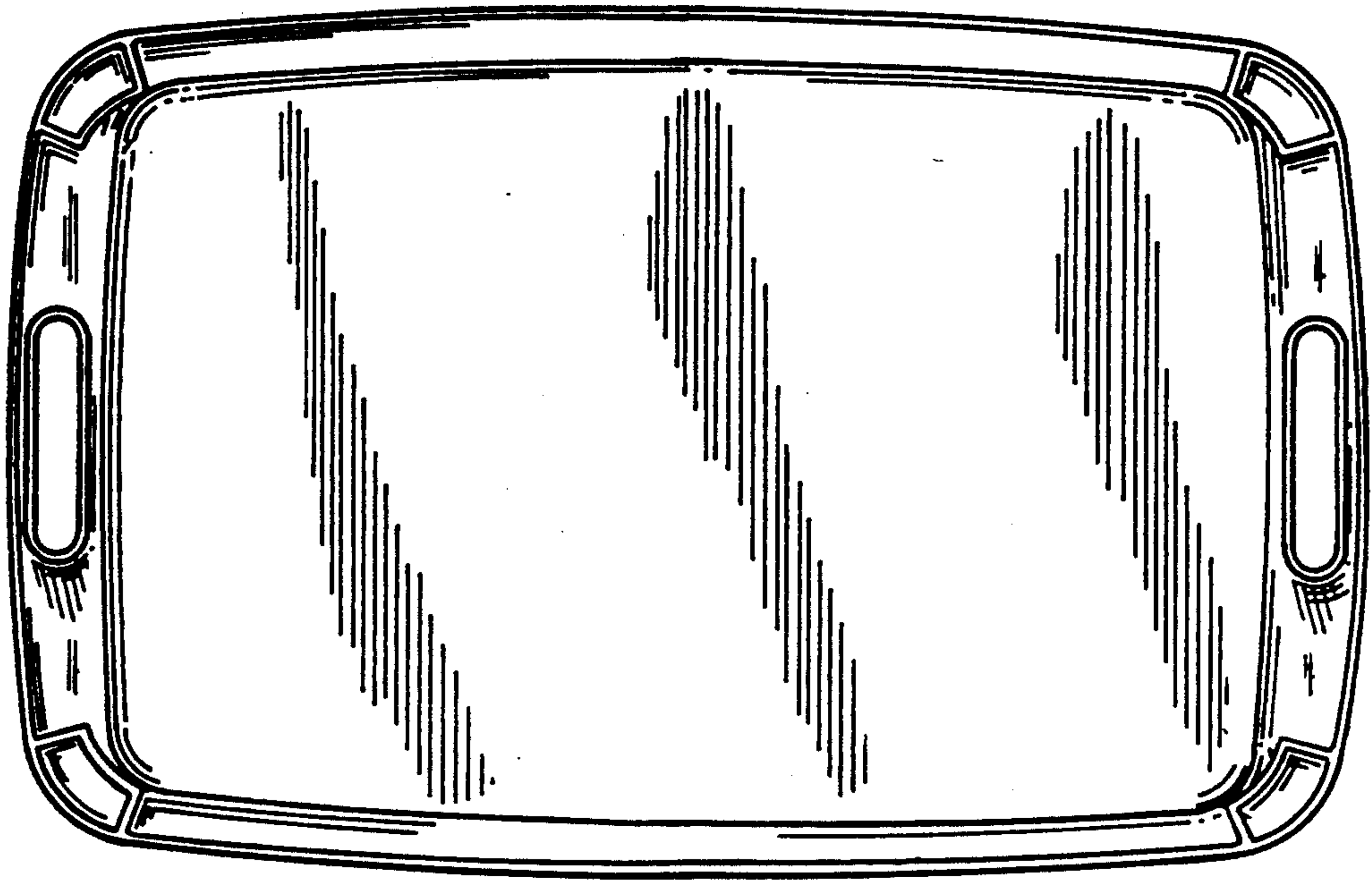

FIG. 4

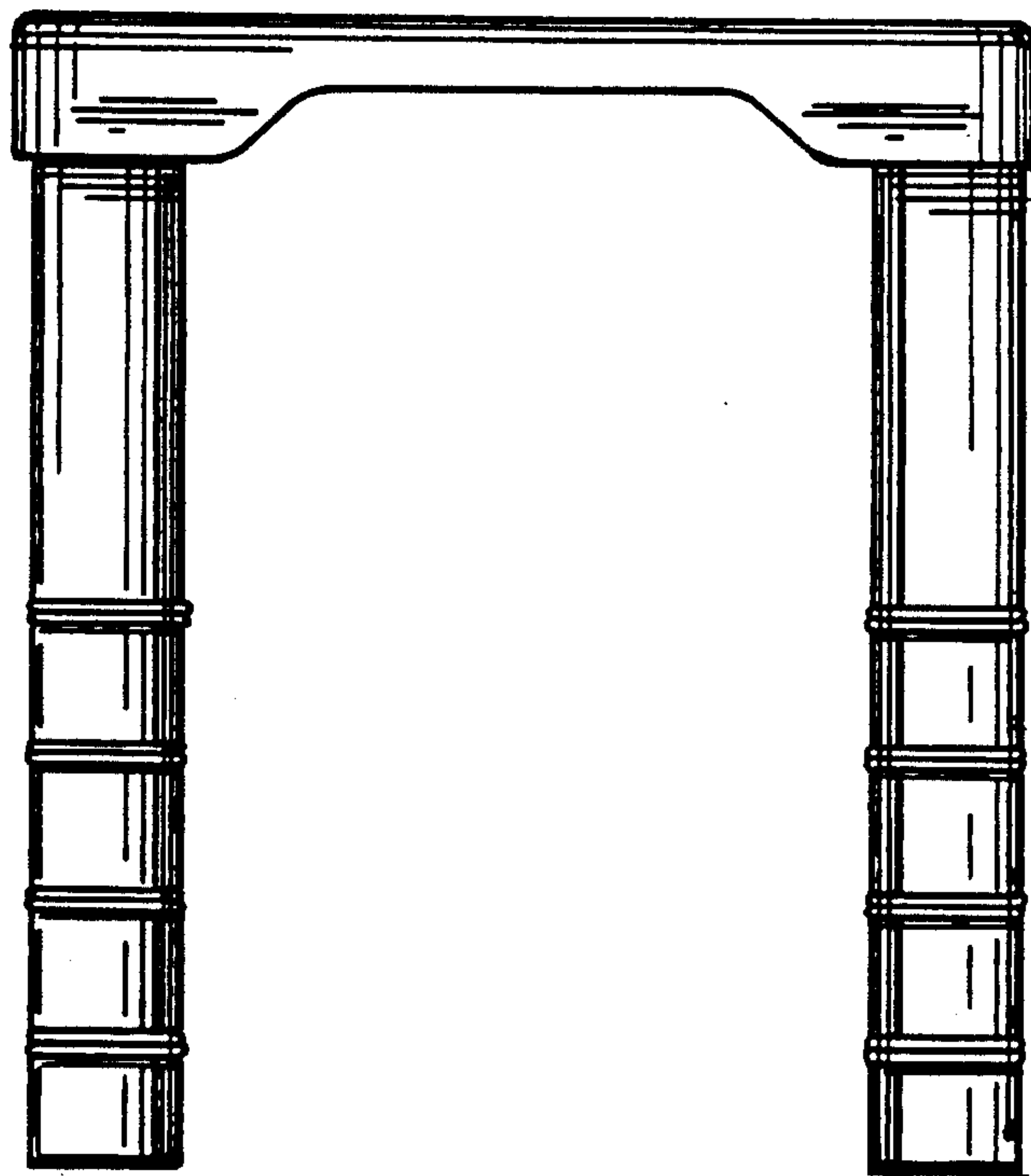

FIG. 5

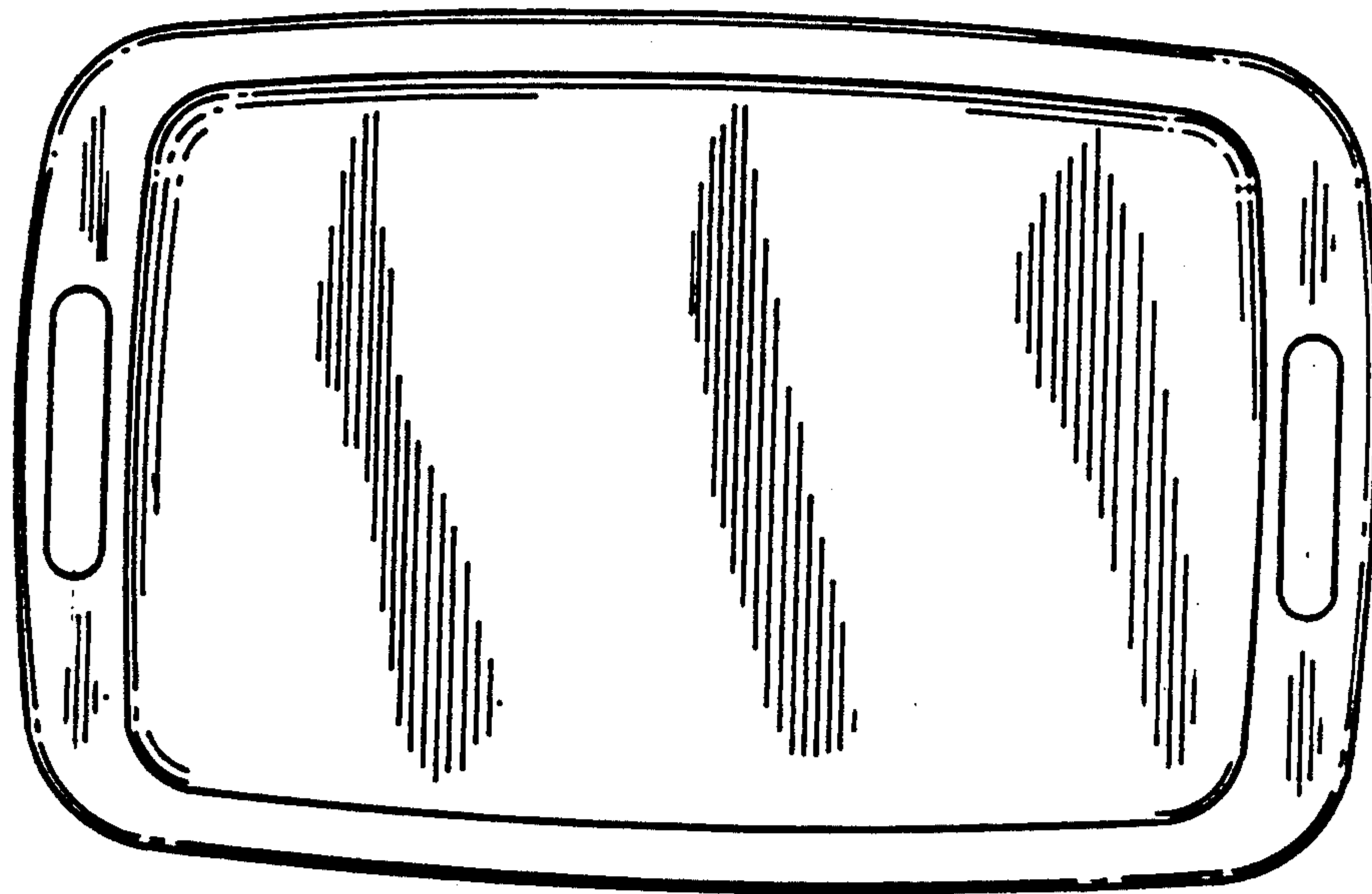

FIG. 6

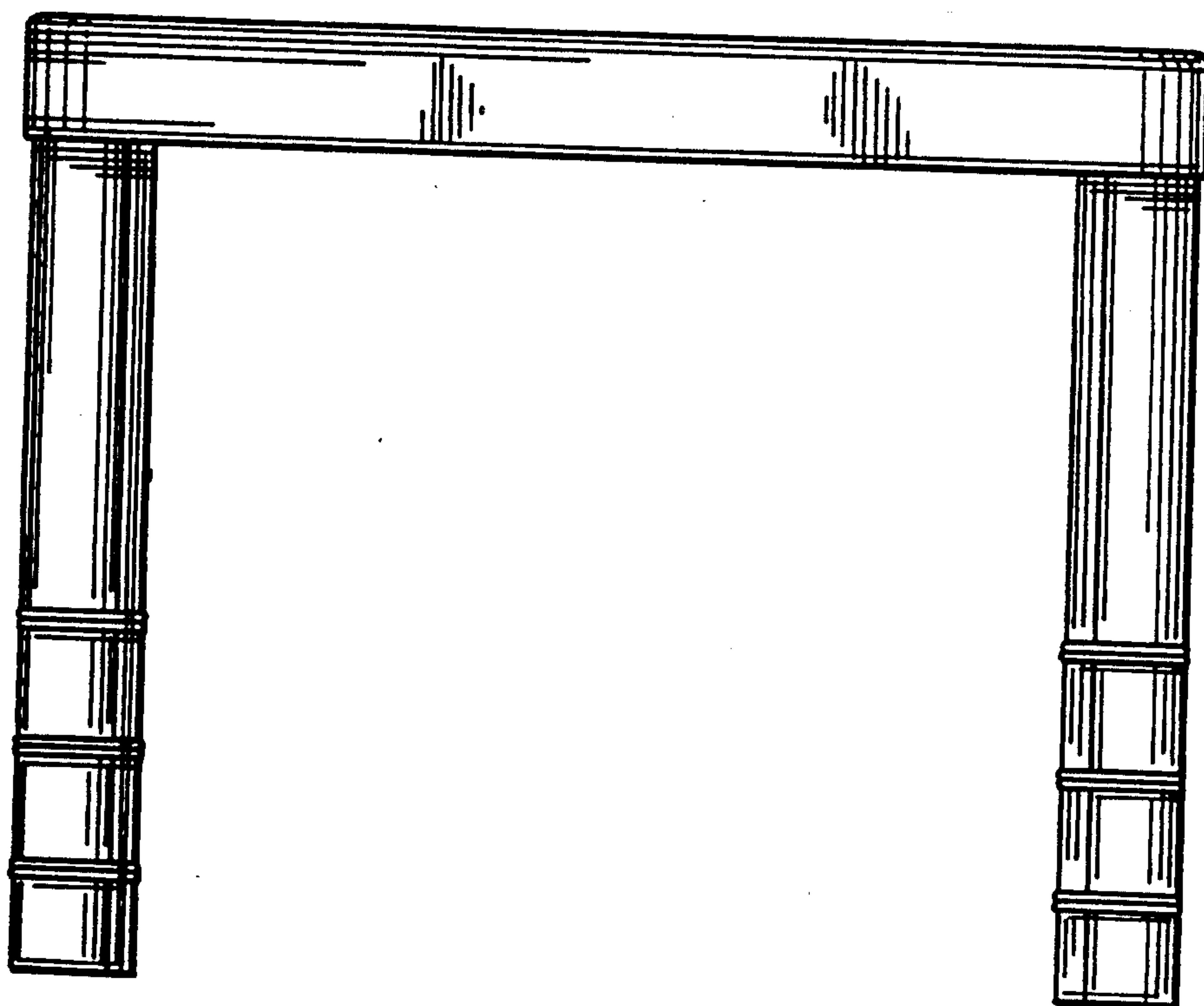

FIG. 7

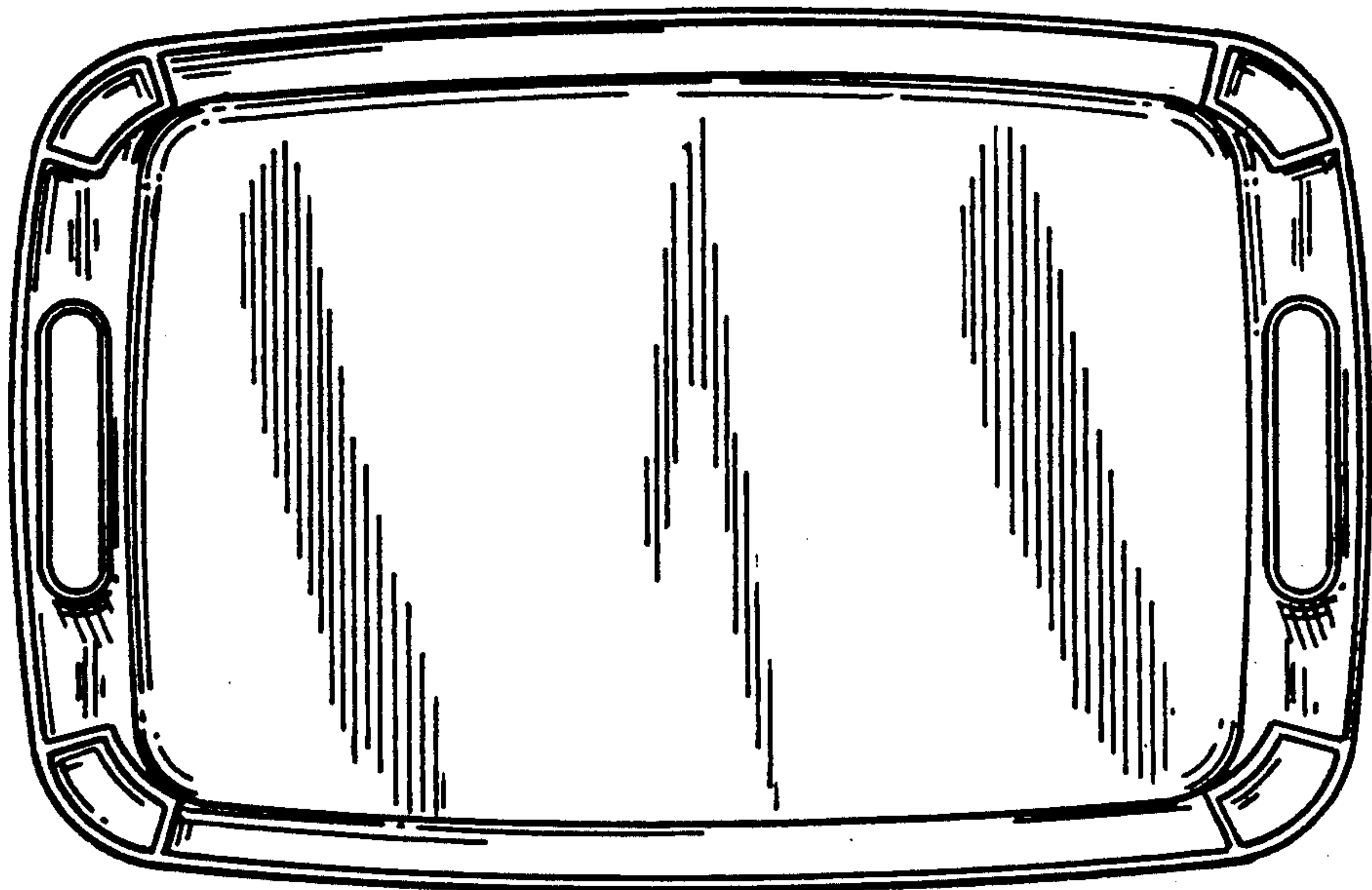

FIG. 8

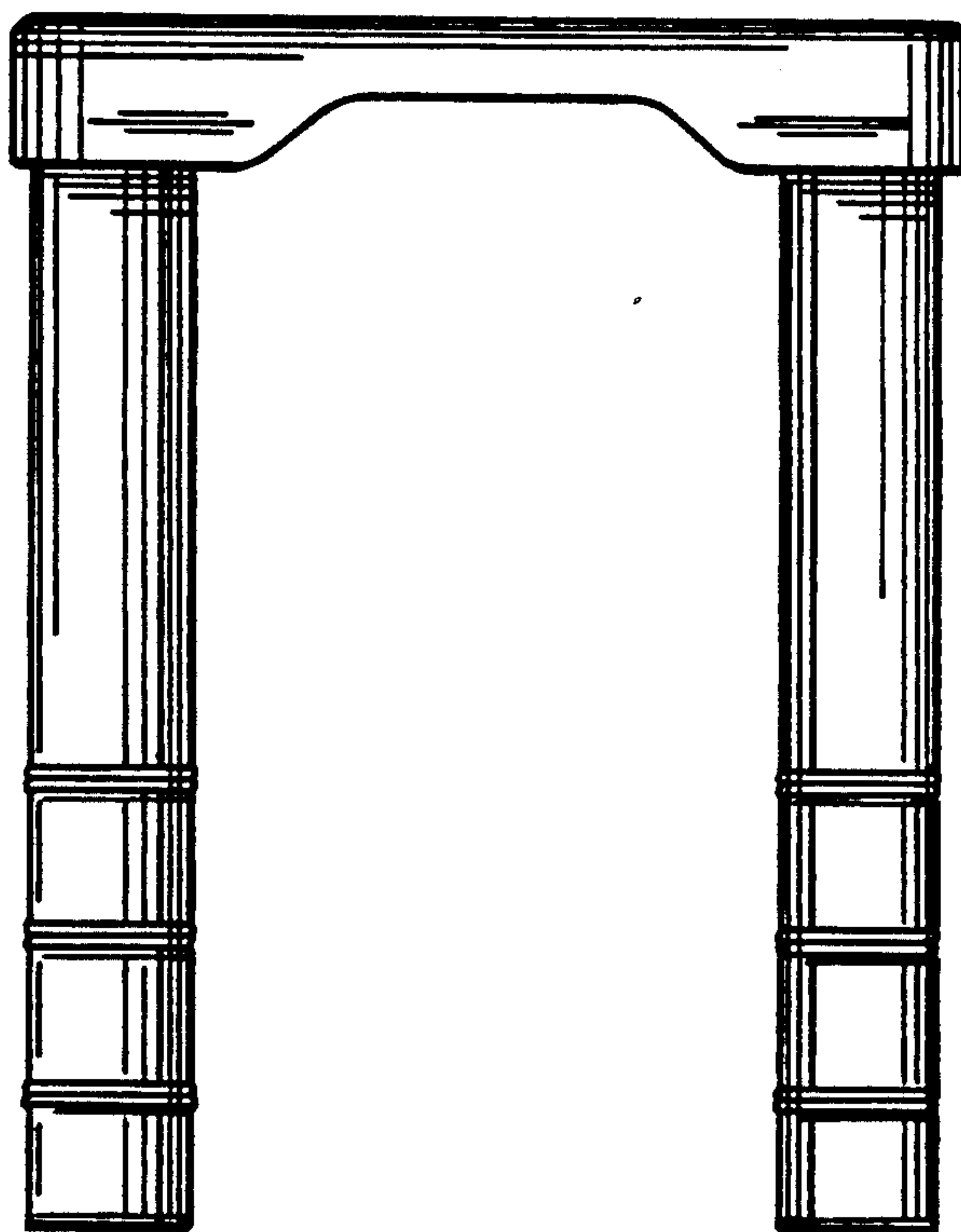

FIG. 9

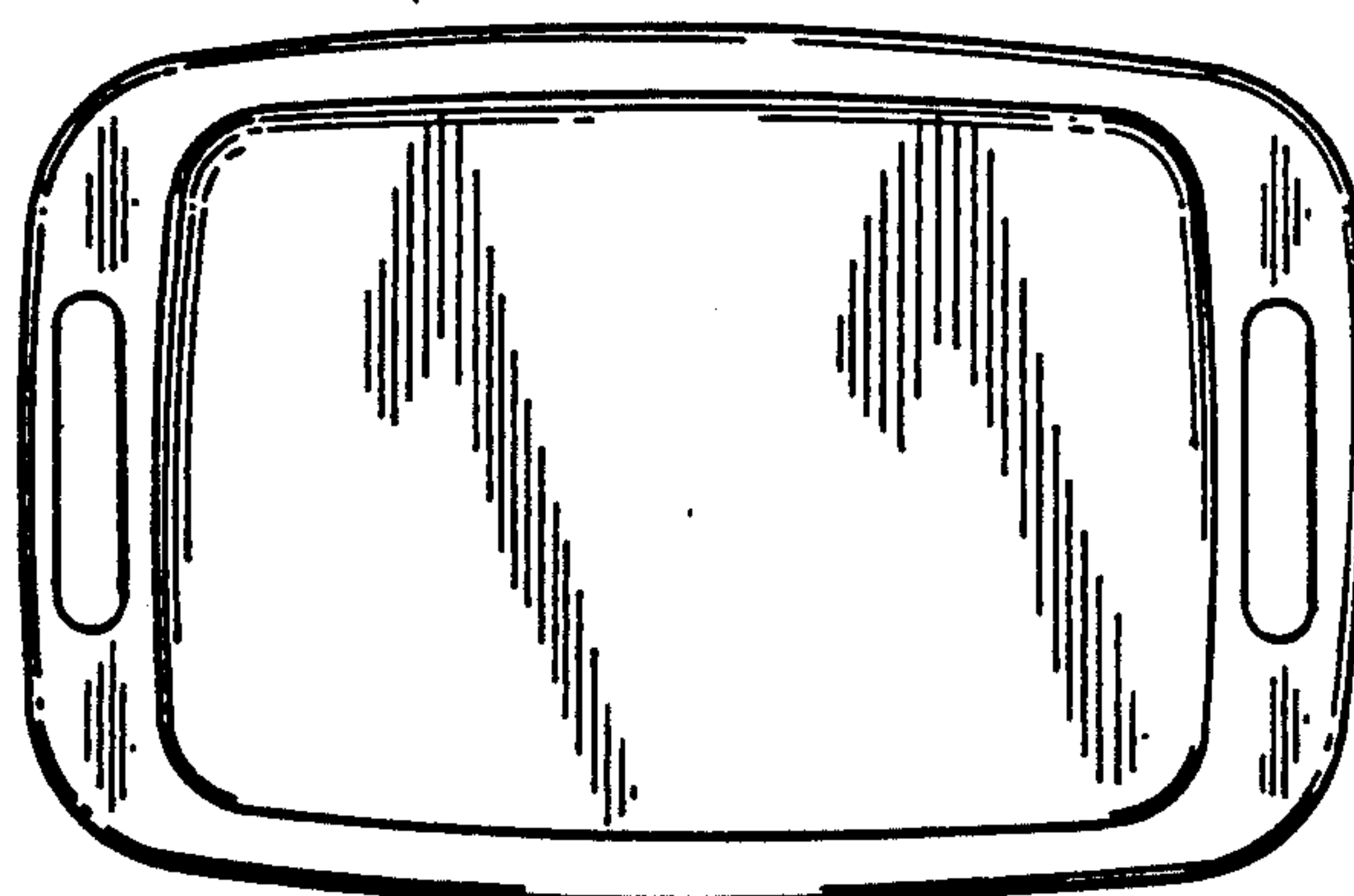

FIG. 10

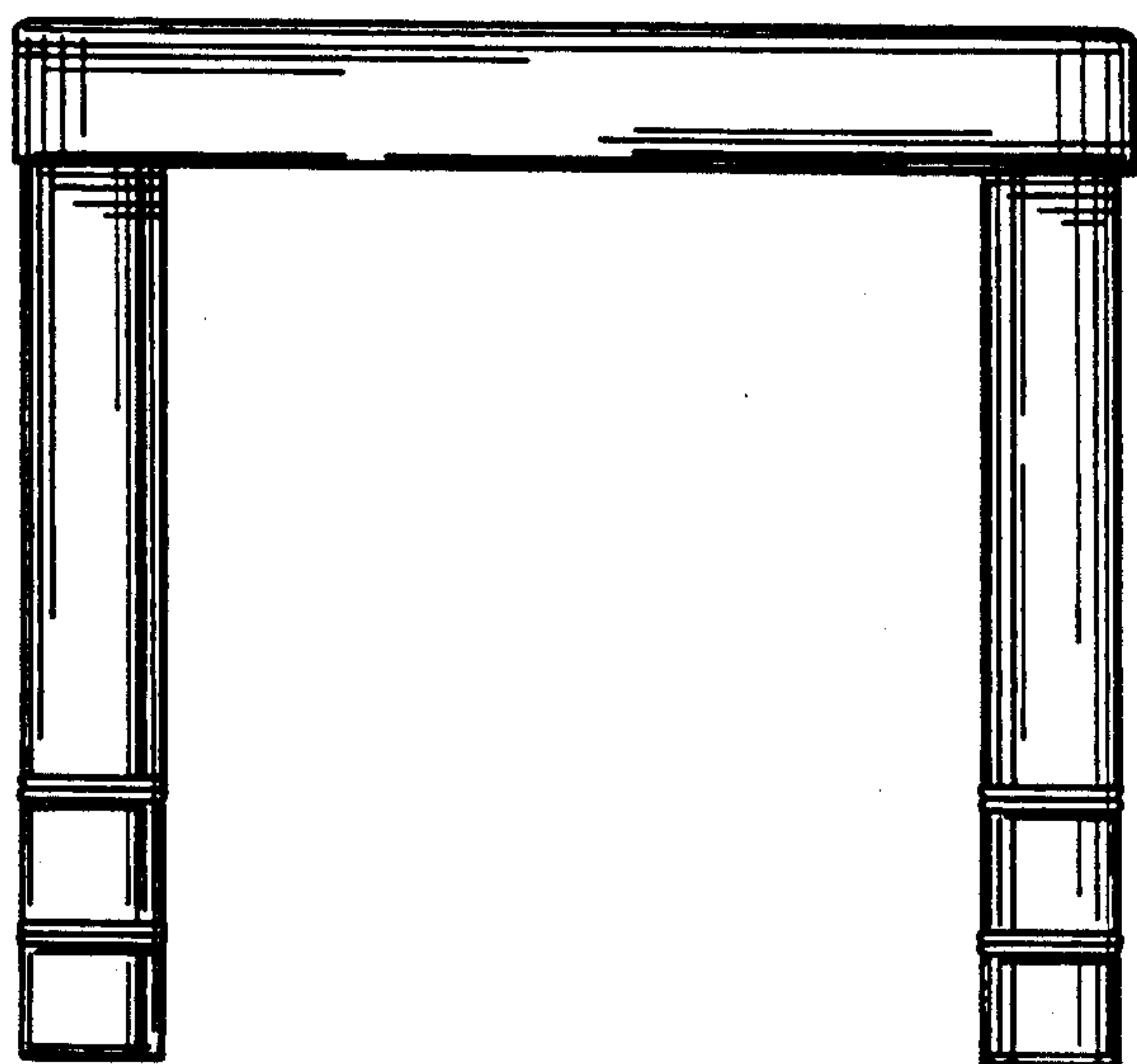

FIG. 11

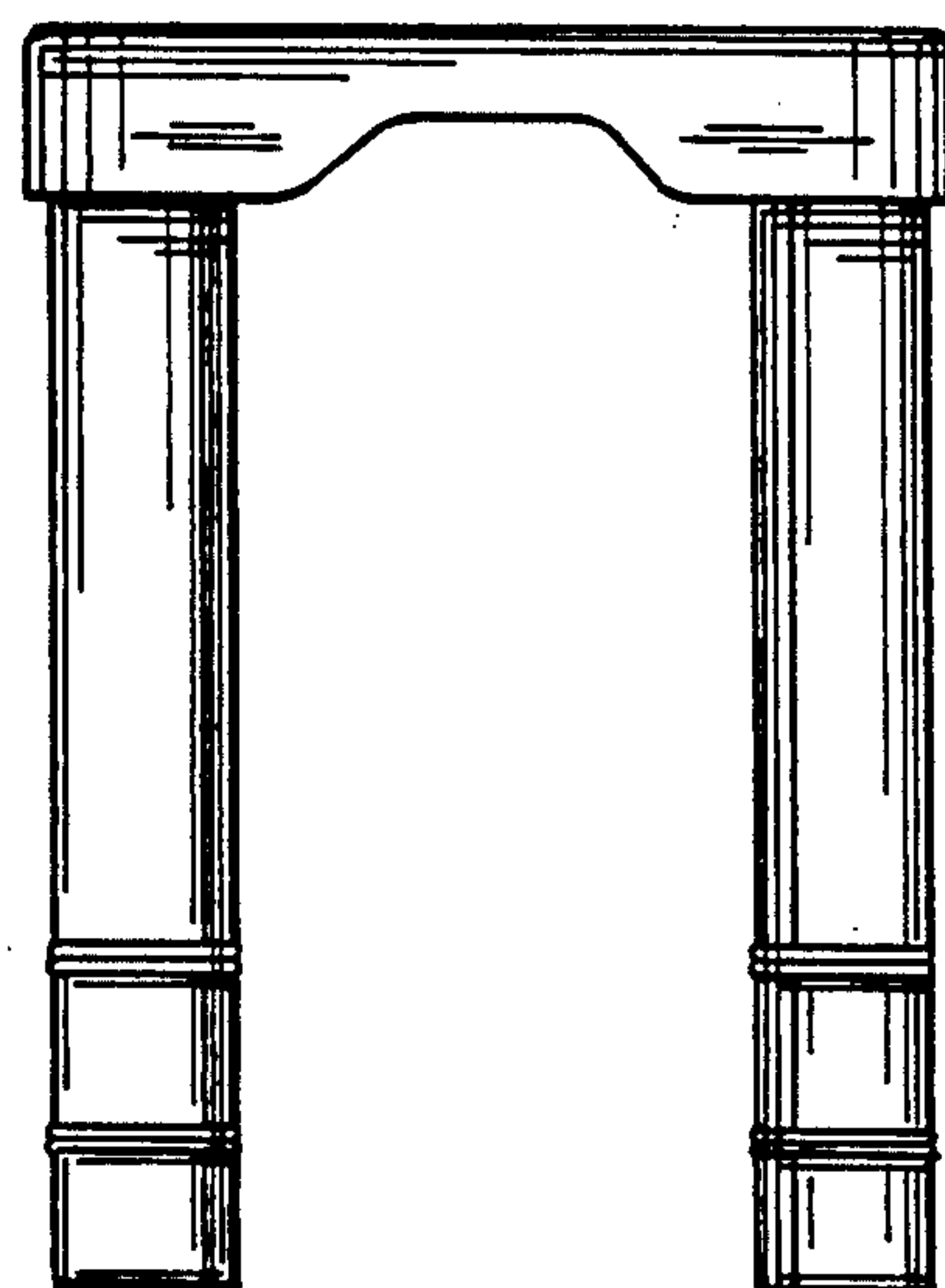

FIG. 13

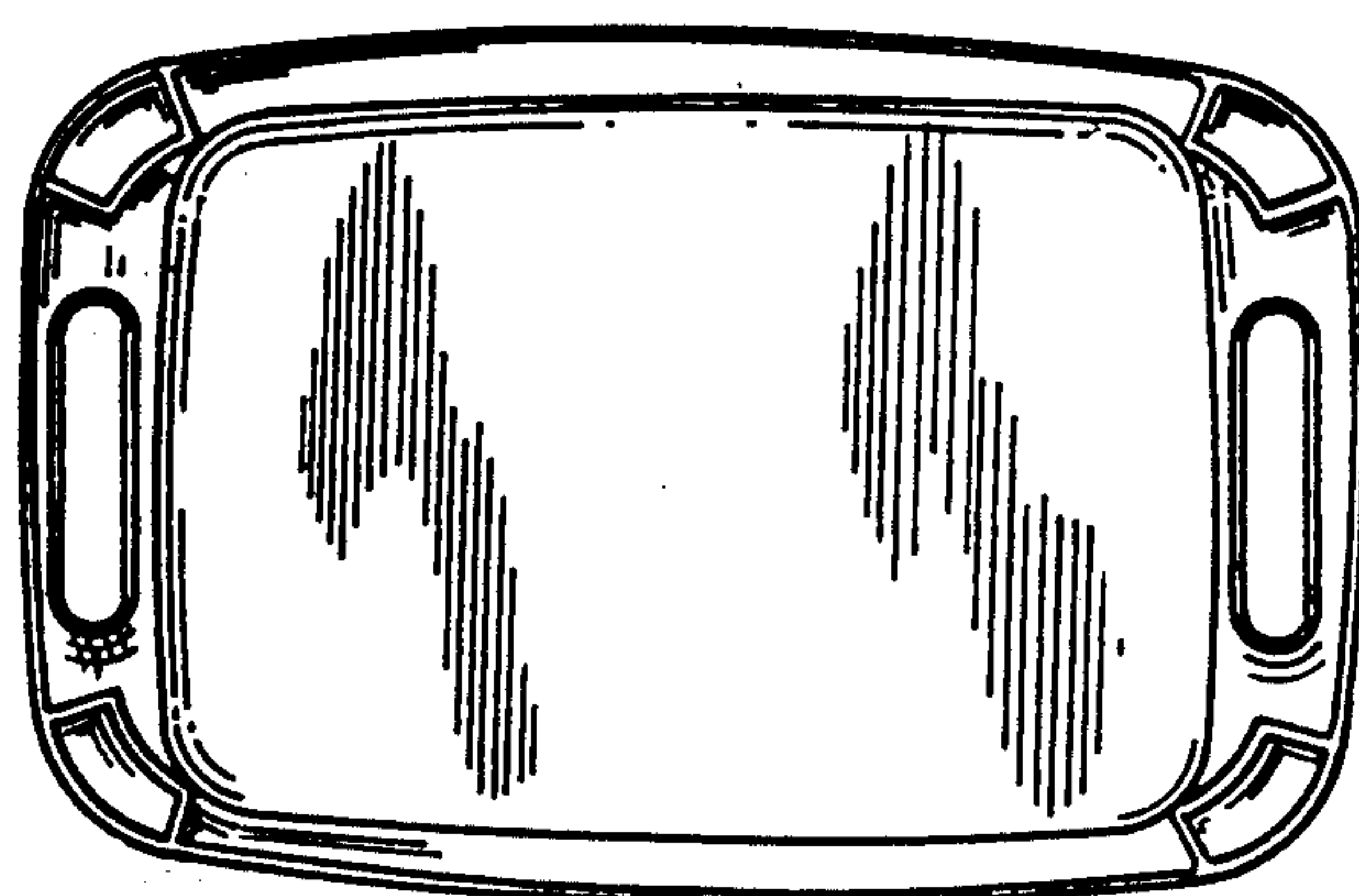

FIG. 12