

United States Patent [19]

Kwan

[11] Patent Number: Des. 315,029

[45] Date of Patent: ** Feb. 26, 1991

[54] PORTABLE FLUORESCENT LAMP

[75] Inventor: Cheng L. Kwan, Kowloon, Hong Kong

[73] Assignee: Hang Tjuk Industrial Co., Ltd., Kowloon, Hong Kong

[**] Term: 14 Years

[21] Appl. No.: 28,333

[22] Filed: Mar. 20, 1987

[30] Foreign Application Priority Data

Dec. 3, 1986 [GB] United Kingdom 1038503

[52] U.S. Cl. D26/42; D26/44; D26/46

[58] Field of Search D26/37-50; 362/157, 158, 183-208

[56] References Cited

U.S. PATENT DOCUMENTS

D. 276,079 10/1984 Cheng Lap-Kwan D26/42
D. 284,106 6/1986 Drane D26/44

D. 297,372 8/1988 Poon D26/44

Primary Examiner—Susan J. Lucas
Attorney, Agent, or Firm—Wolf, Greenfield & Sacks

[57] CLAIM

The ornamental design for a portable fluorescent lamp, as shown and described.

DESCRIPTION

FIG. 1 is a top, front, right sider perspective view of a portable fluorescent lamp showing my new design; FIG. 2 is an exploded bottom, front right side perspective view thereof; FIG. 3 is a front elevational view thereof on an enlarged scale; FIG. 4 is a rear elevational view thereof on an enlarged scale; FIG. 5 is a top plan view thereof on an enlarged scale; FIG. 6 is a left side elevational view thereof on an enlarged scale; FIG. 7 is a right side elevational view thereof on an enlarged scale; FIG. 8 is a bottom plan view thereof.

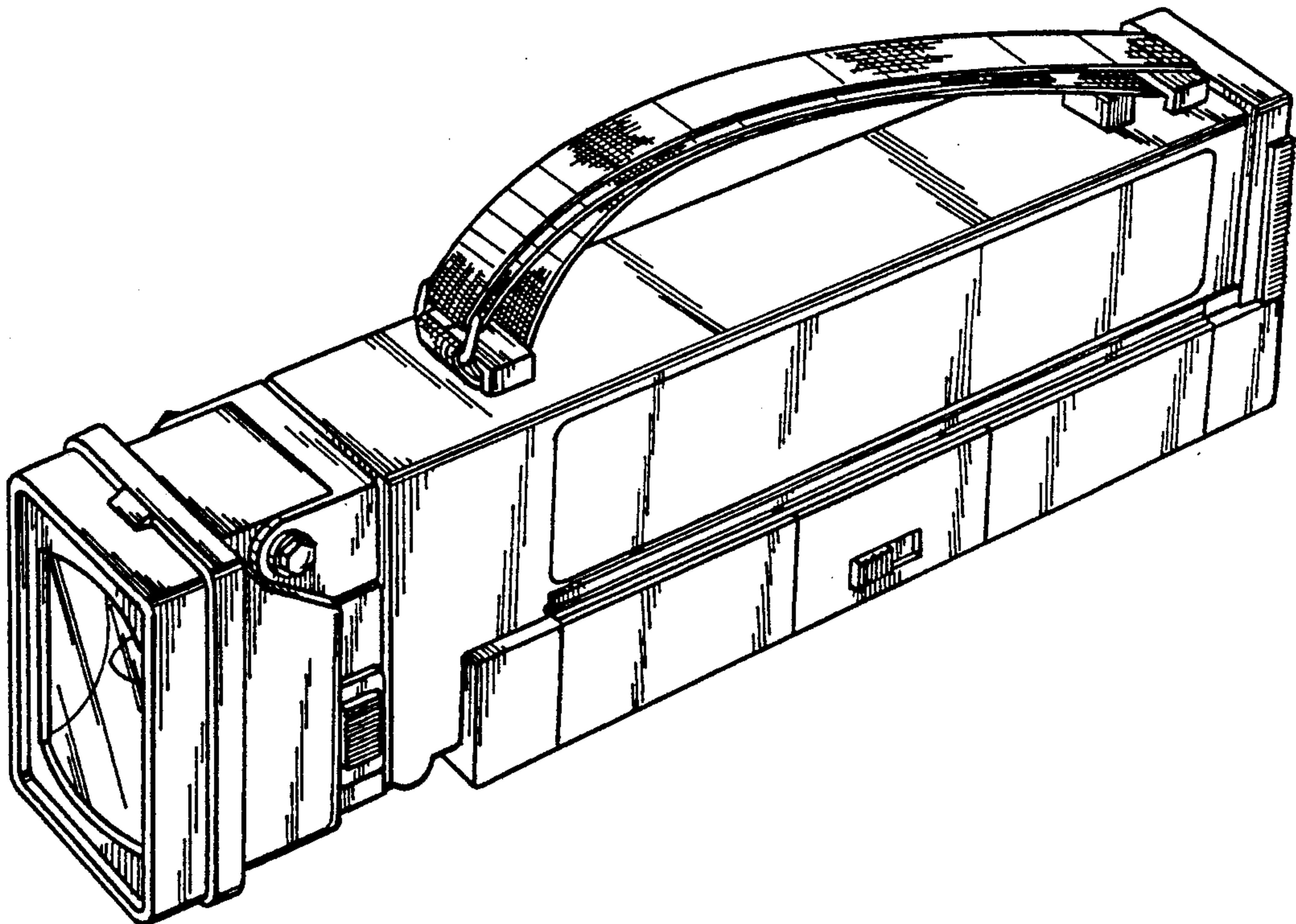

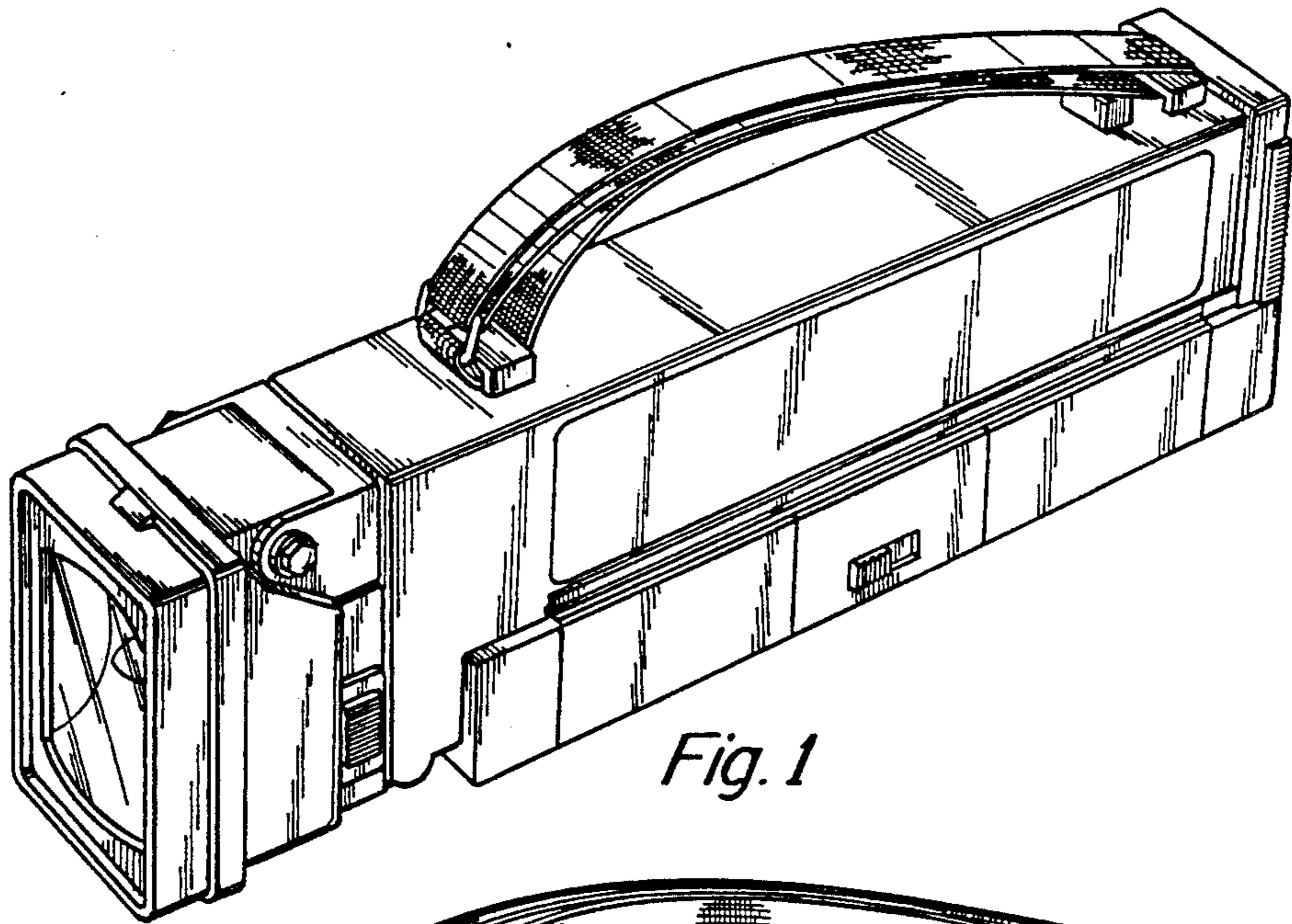

Fig. 1

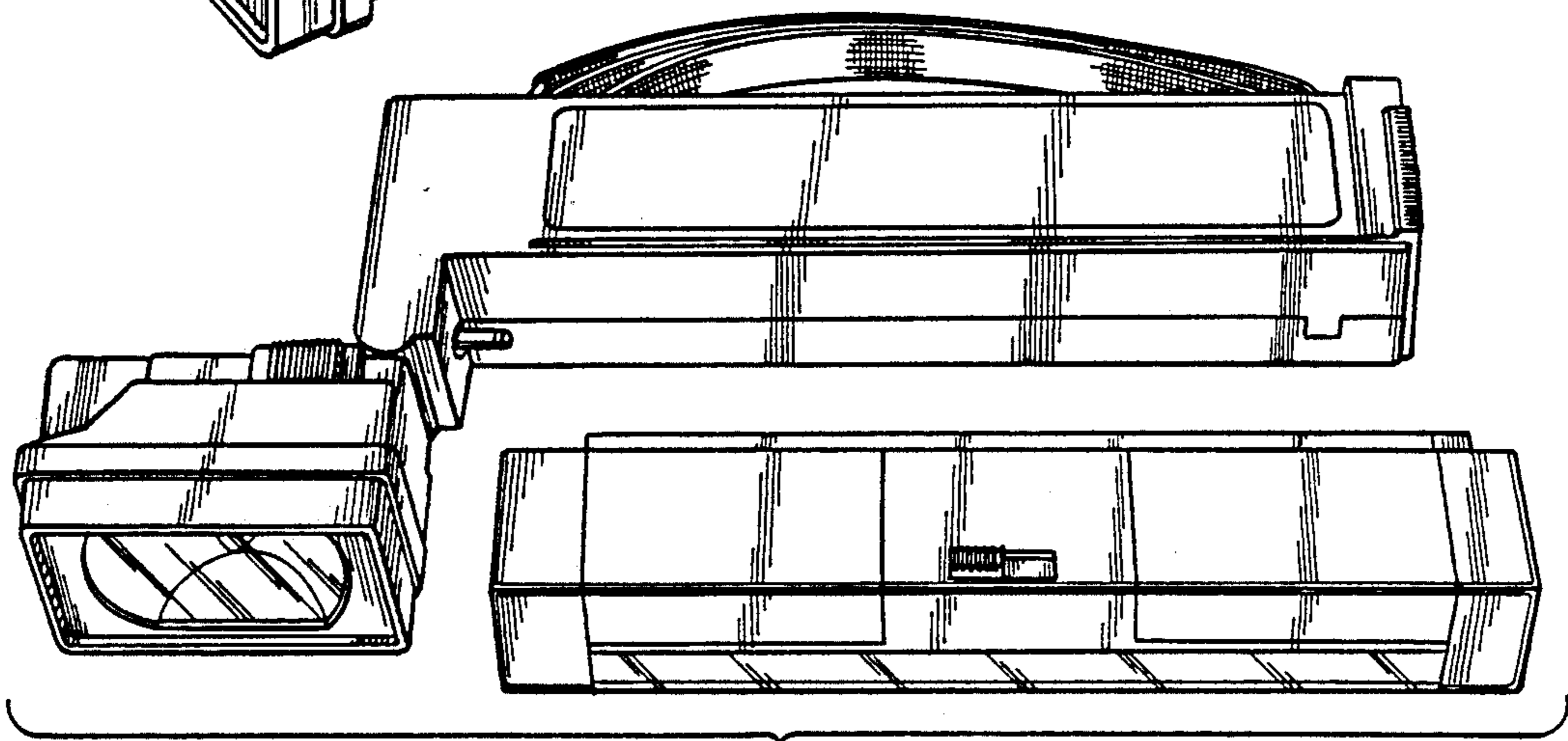

Fig. 2

Fig. 3

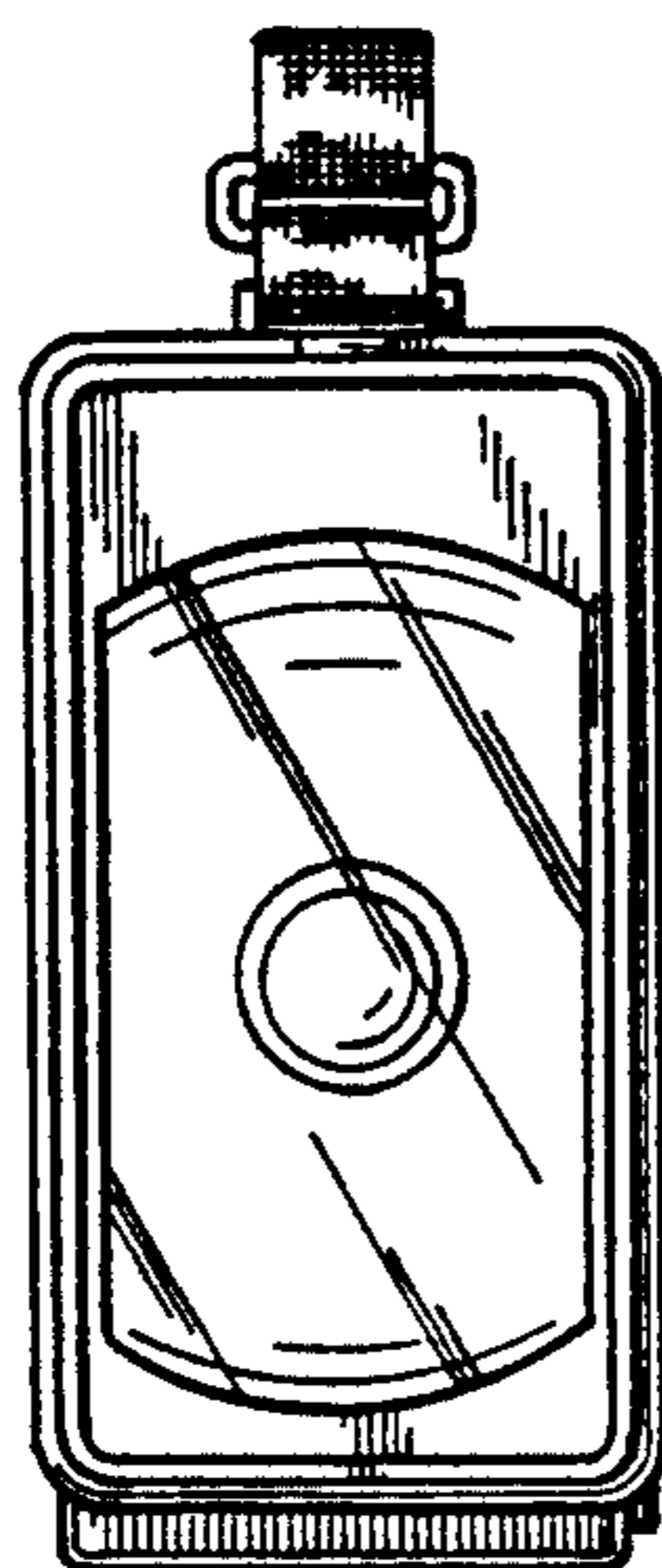
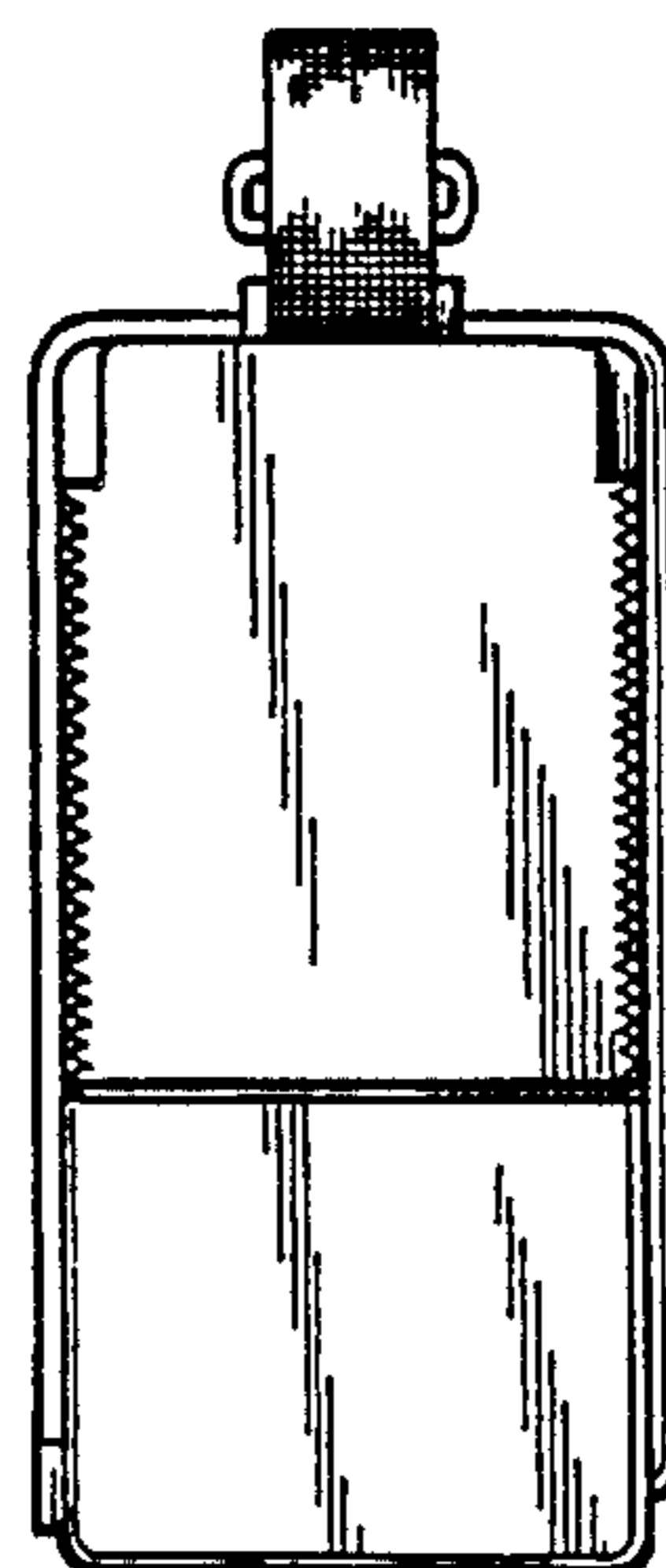

Fig. 4



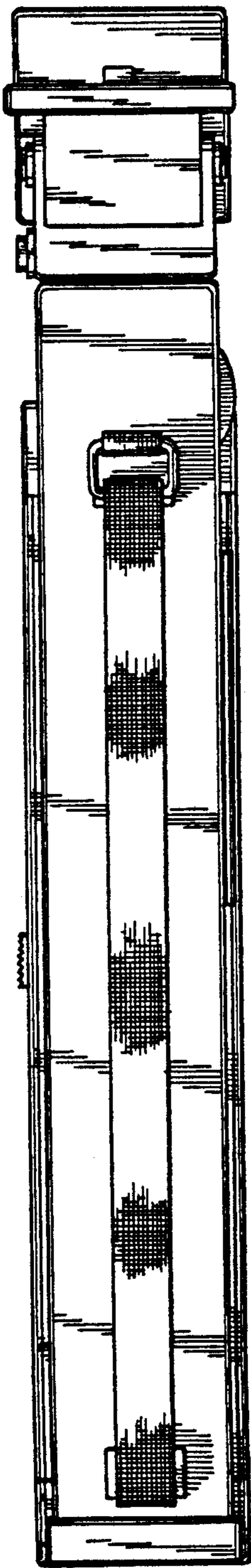

Fig. 5

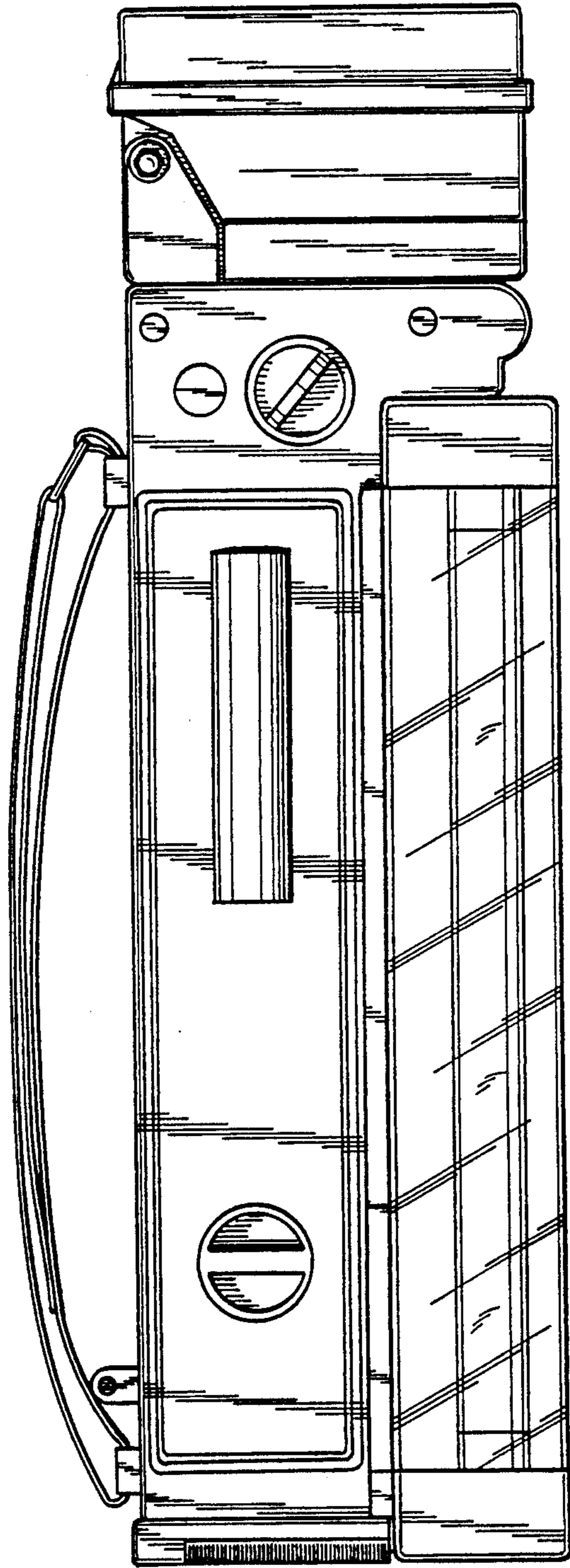

Fig. 6

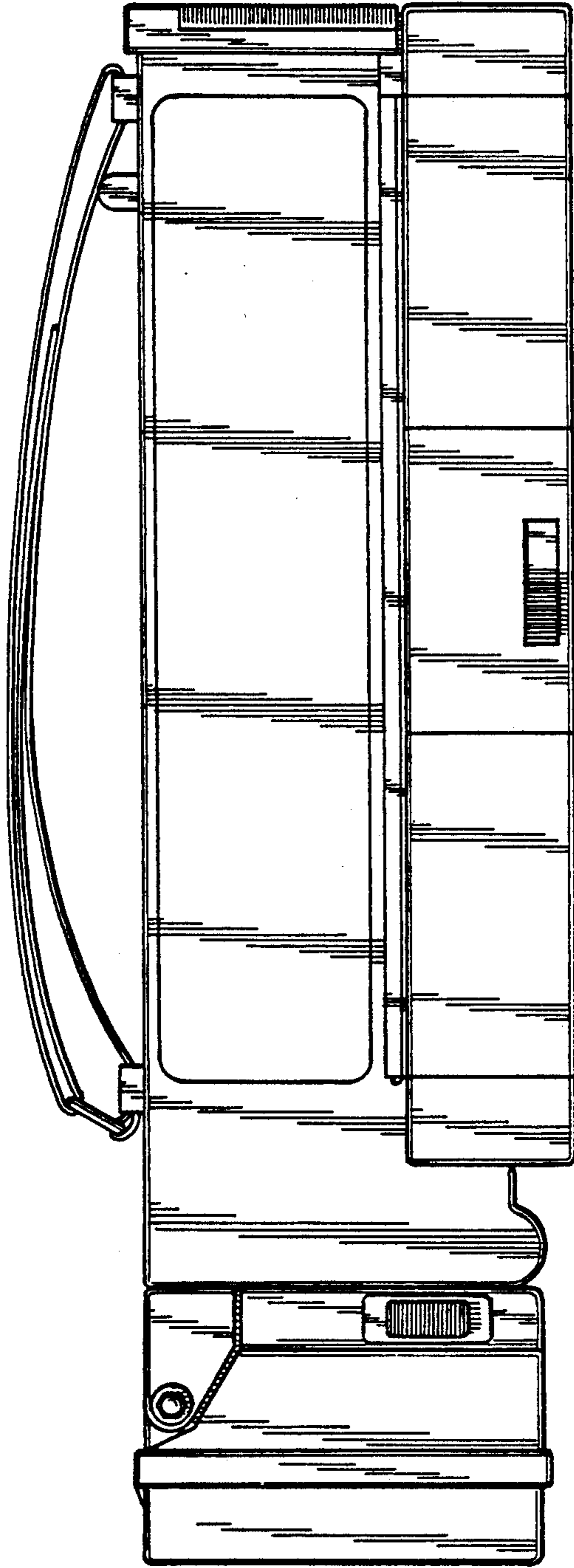

Fig. 7

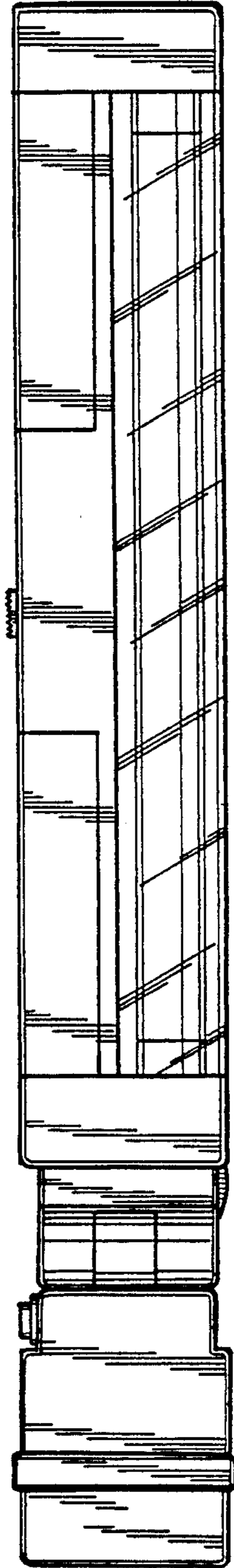

Fig. 8