

[54] VIDEO DISPLAY TERMINAL OR SIMILAR ARTICLE

[75] Inventors: Anthony R. Orchard, Wantagh; Paul Matwey, Mt. Sinai; Lloyd A. Samuels, Kew Garden Hills; Brian K. Fisher, Douglaston; Robert G. Doherty, Massapequa Park, all of N.Y.

[73] Assignee: NCR Corporation, Dayton, Ohio

[**] Term: 14 Years

[21] Appl. No.: 261,642

[22] Filed: Oct. 21, 1988

[52] U.S. Cl. D14/113

[58] Field of Search D14/100, 106, 107, 113, D14/115, 125, 126; D18/1, 7, 11, 12; 235/145 A, 145 R; 312/208; 340/700, 706, 711, 712; 341/22, 23; 364/706-710

[56] References Cited

U.S. PATENT DOCUMENTS

D. 289,651 5/1987 Nuttall et al. D14/113

D. 294,944 3/1988 Chu D14/113
D. 299,825 2/1989 Dickie D14/106
D. 300,929 5/1989 Satherley D14/113
D. 304,719 11/1989 Leung D14/113

Primary Examiner—Wallace R. Burke
Assistant Examiner—Freda S. Nunn
Attorney, Agent, or Firm—Wilbert Hawk, Jr.; Stephen F. Jewett; Jack R. Penrod

[57] CLAIM

The ornamental design for a video display terminal or similar article, as shown and described.

DESCRIPTION

FIG. 1 is a front elevational view of a video display terminal or similar article showing our new design; FIG. 2 is a rear elevational view thereof; FIG. 3 is a left side elevational view thereof; FIG. 4 is a right side elevational view thereof; FIG. 5 is a top plan view thereof; FIG. 6 is a bottom plan view thereof; and FIG. 7 is a perspective view thereof, the keyboard being shown in broken lines for illustrative purposes only and forms no part of the claimed design.

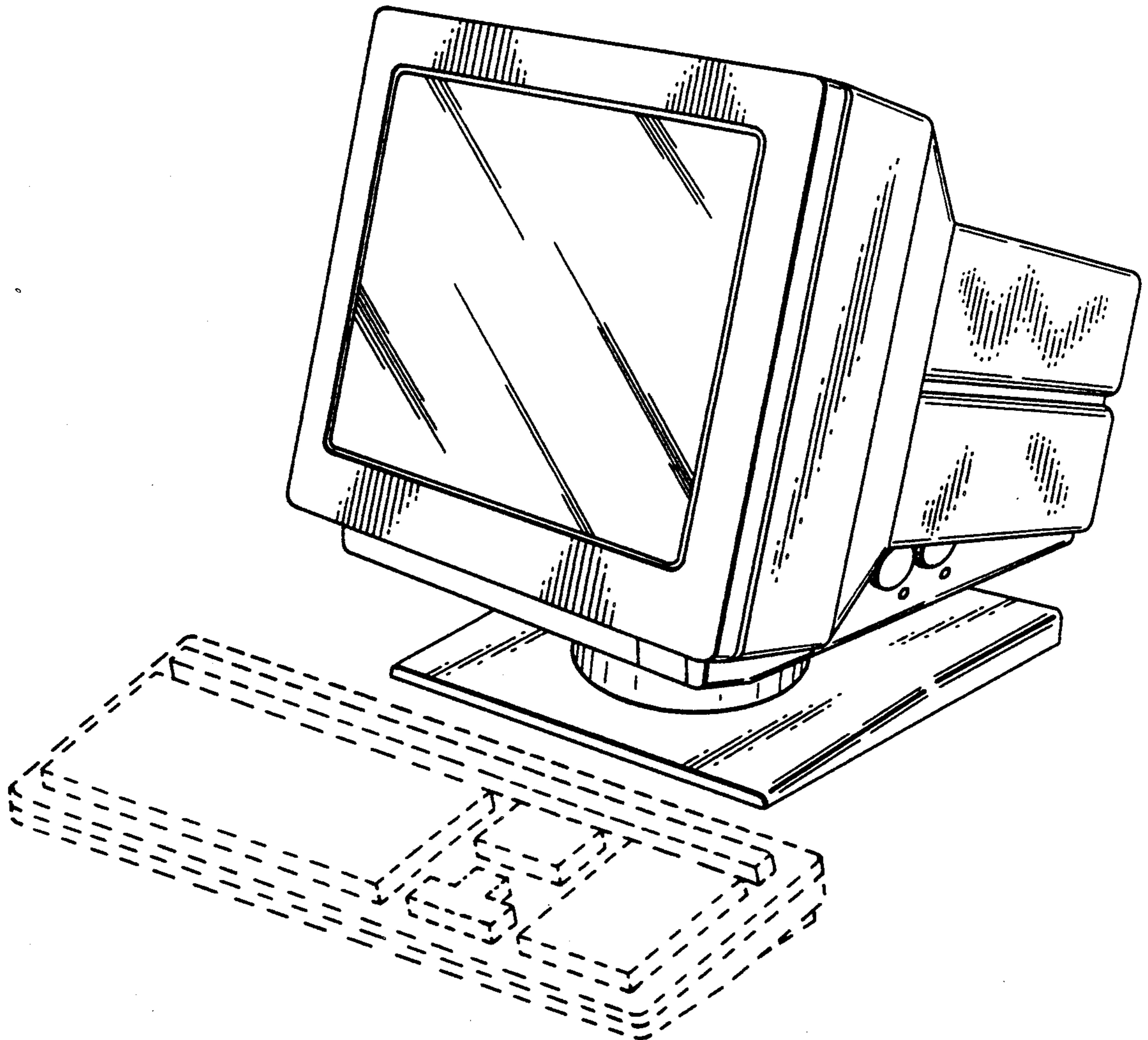

FIG. 1

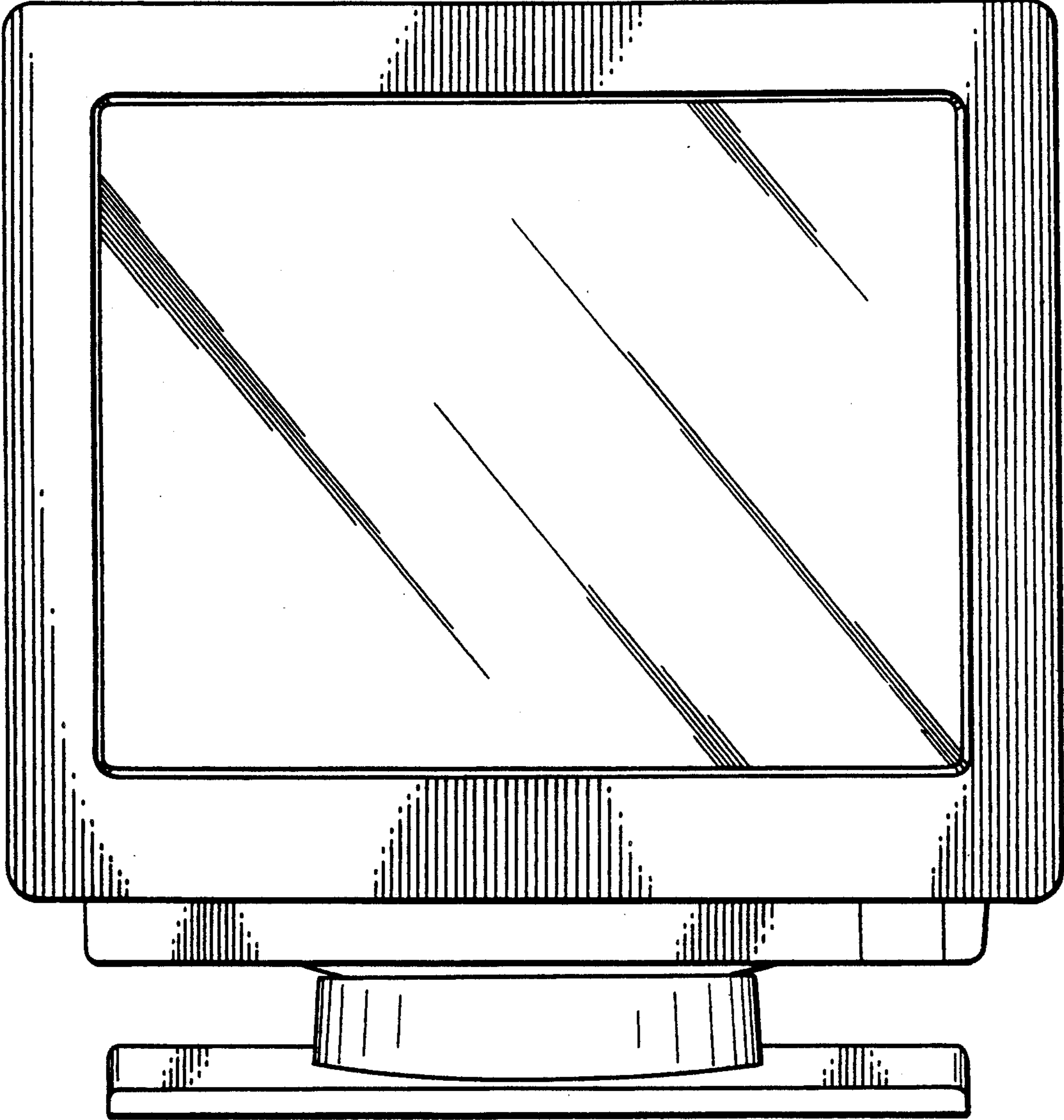

FIG. 2

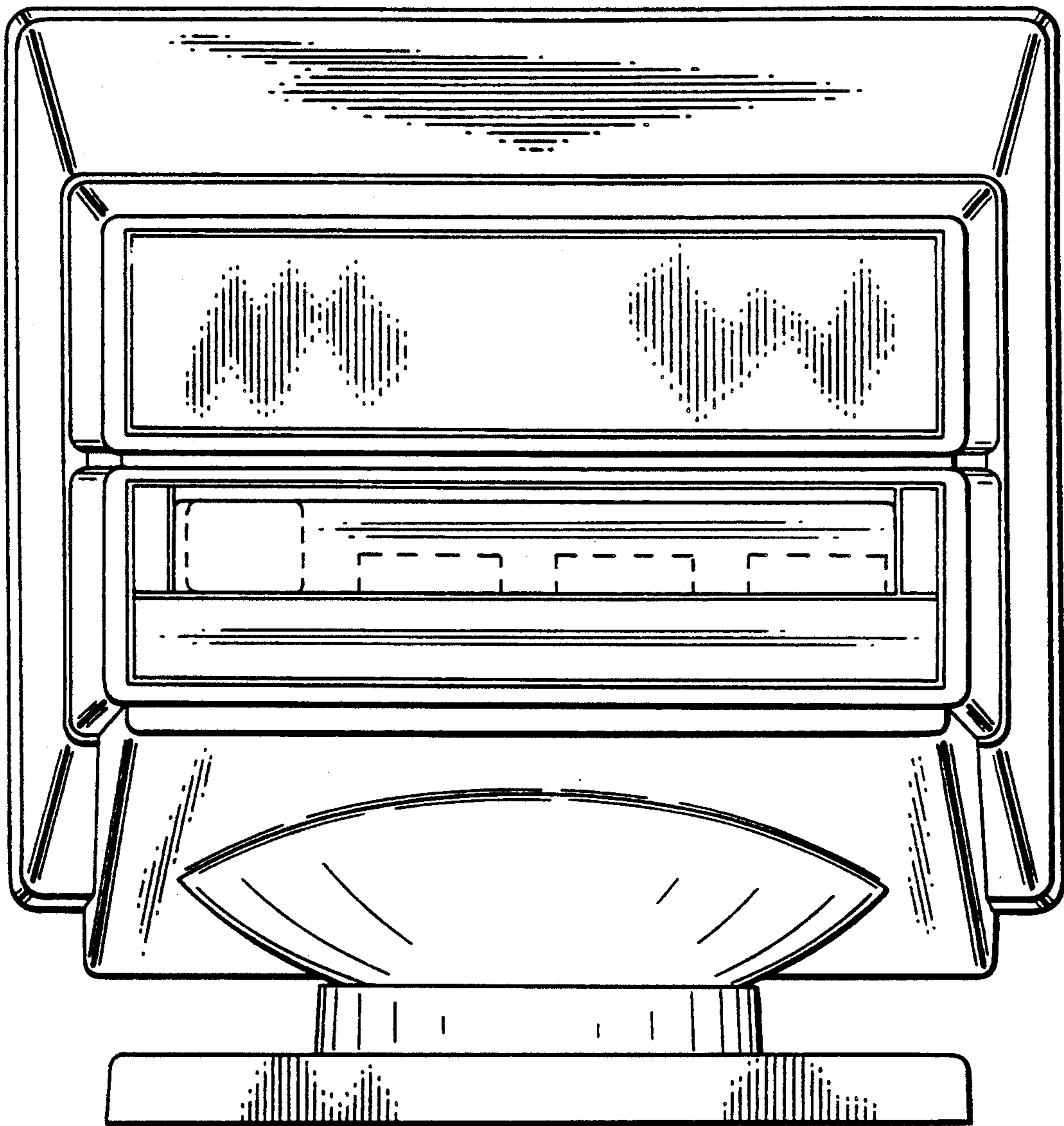

FIG. 3

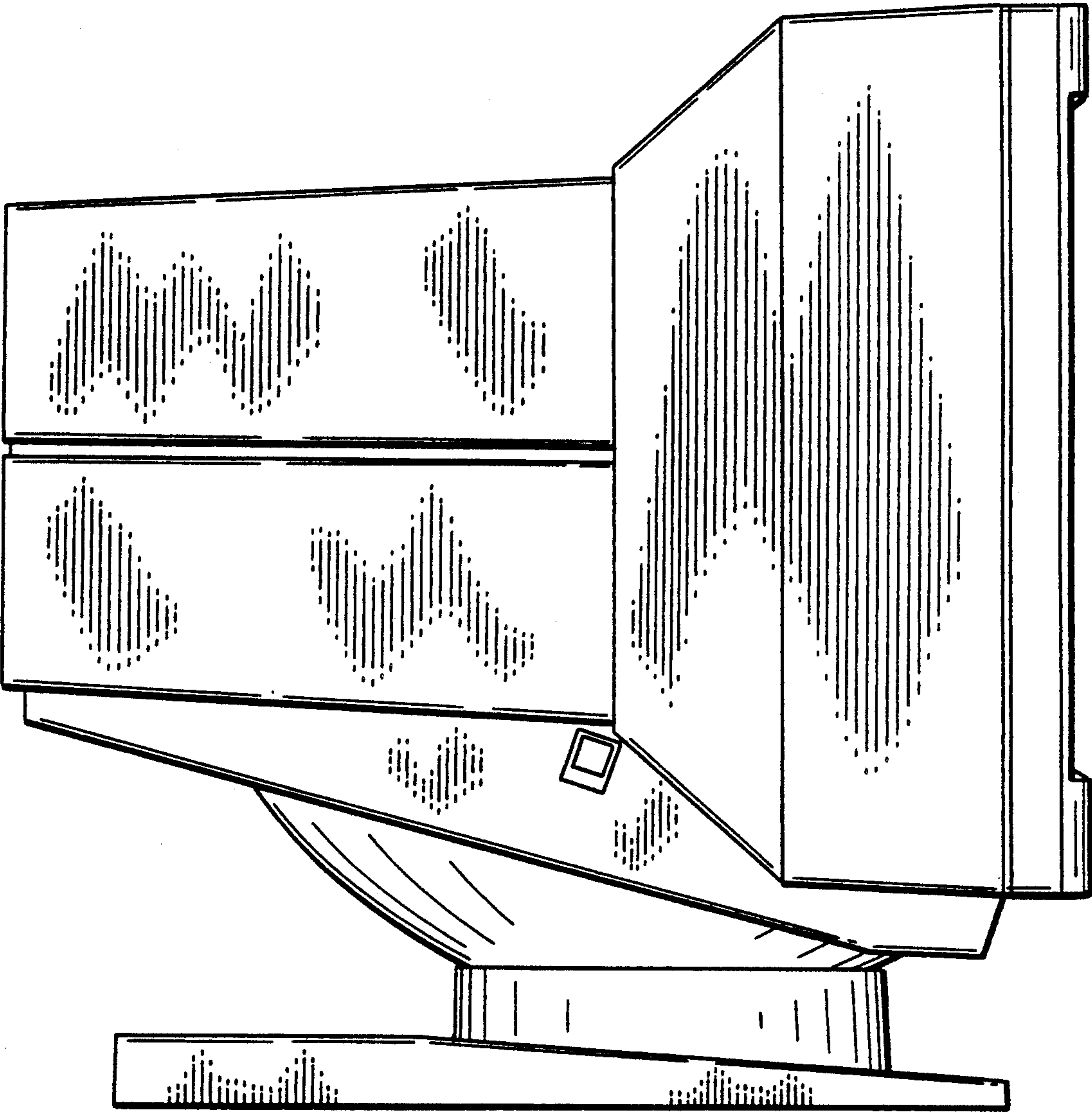

FIG. 4

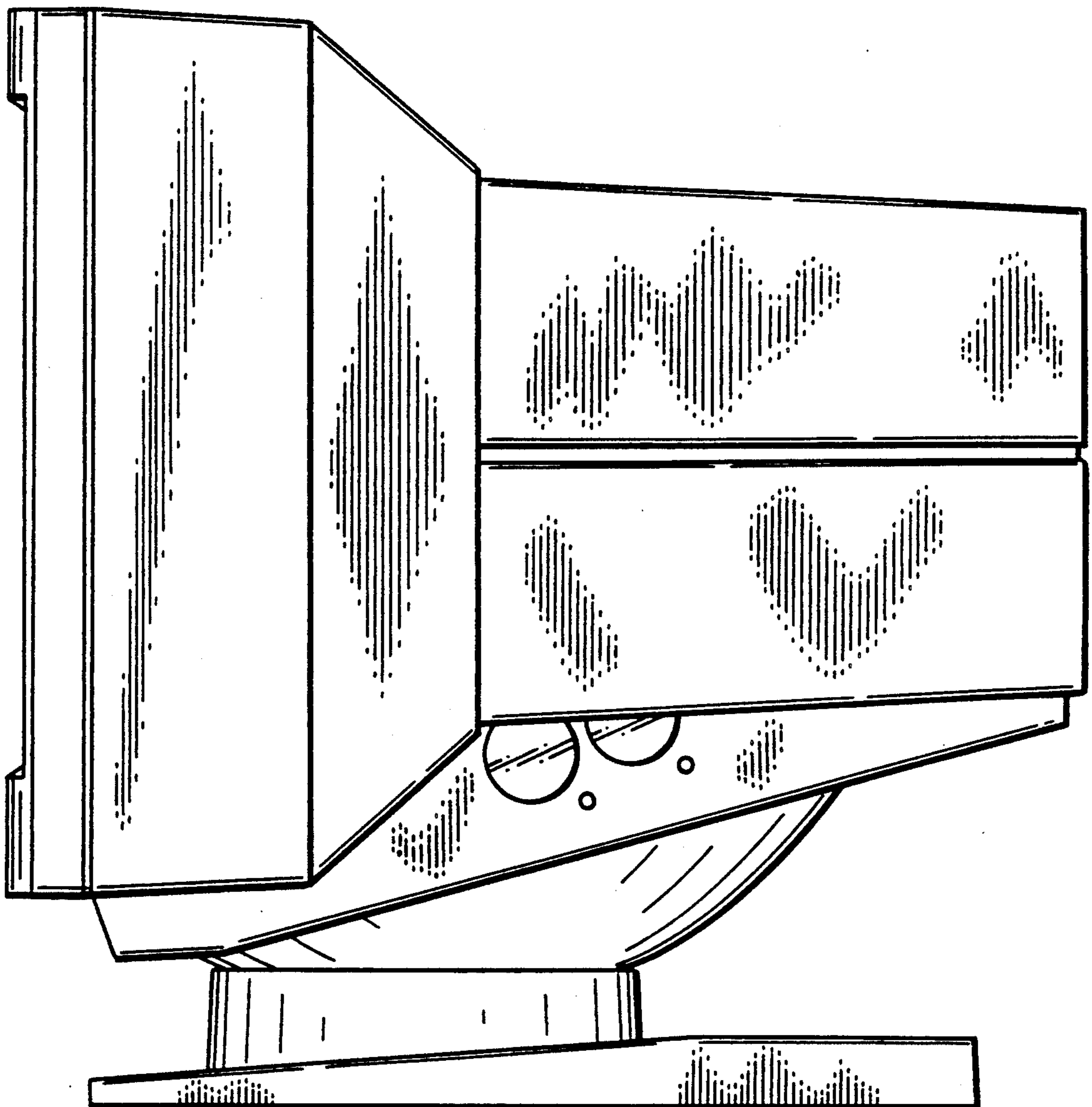

FIG. 5

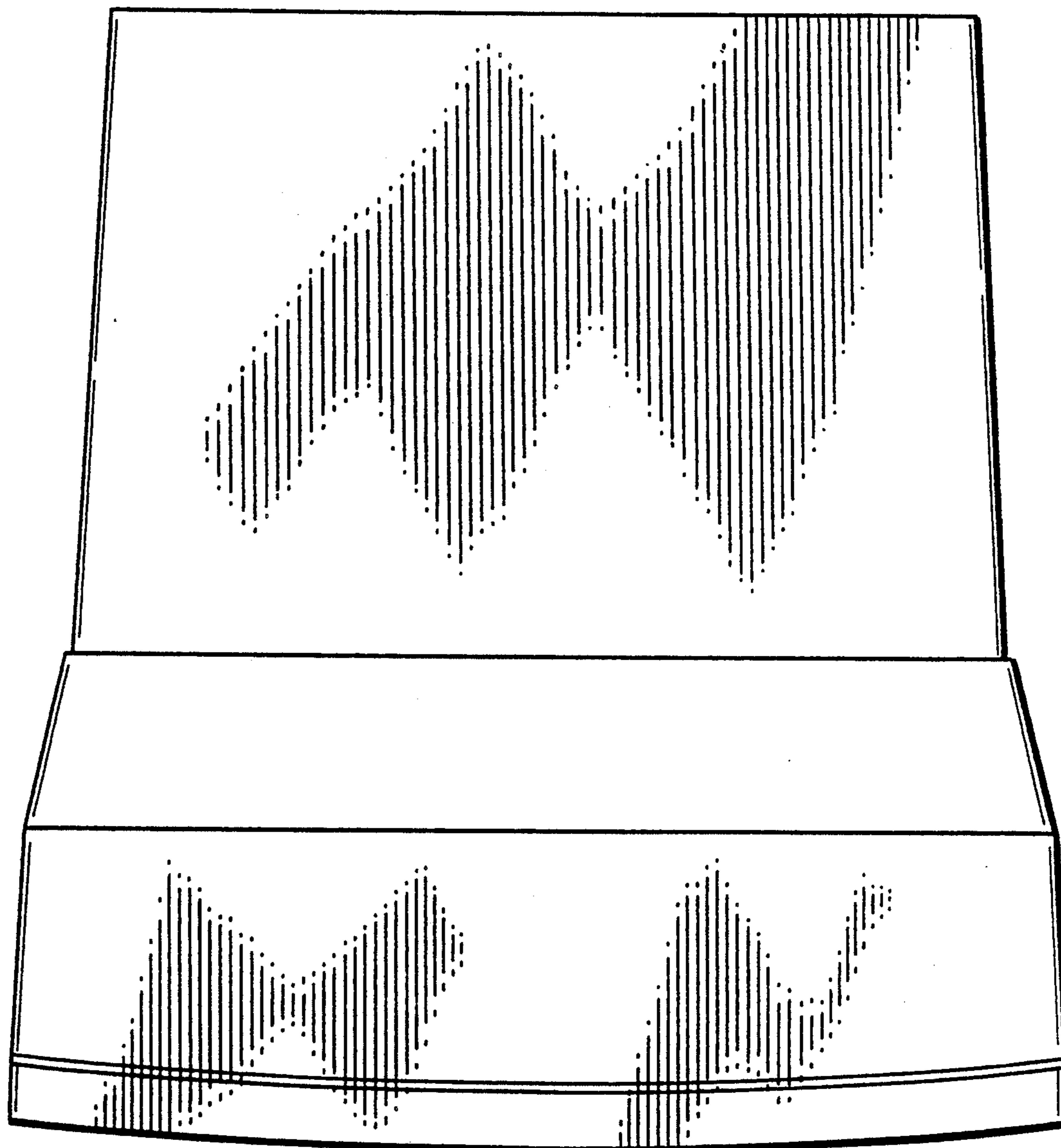
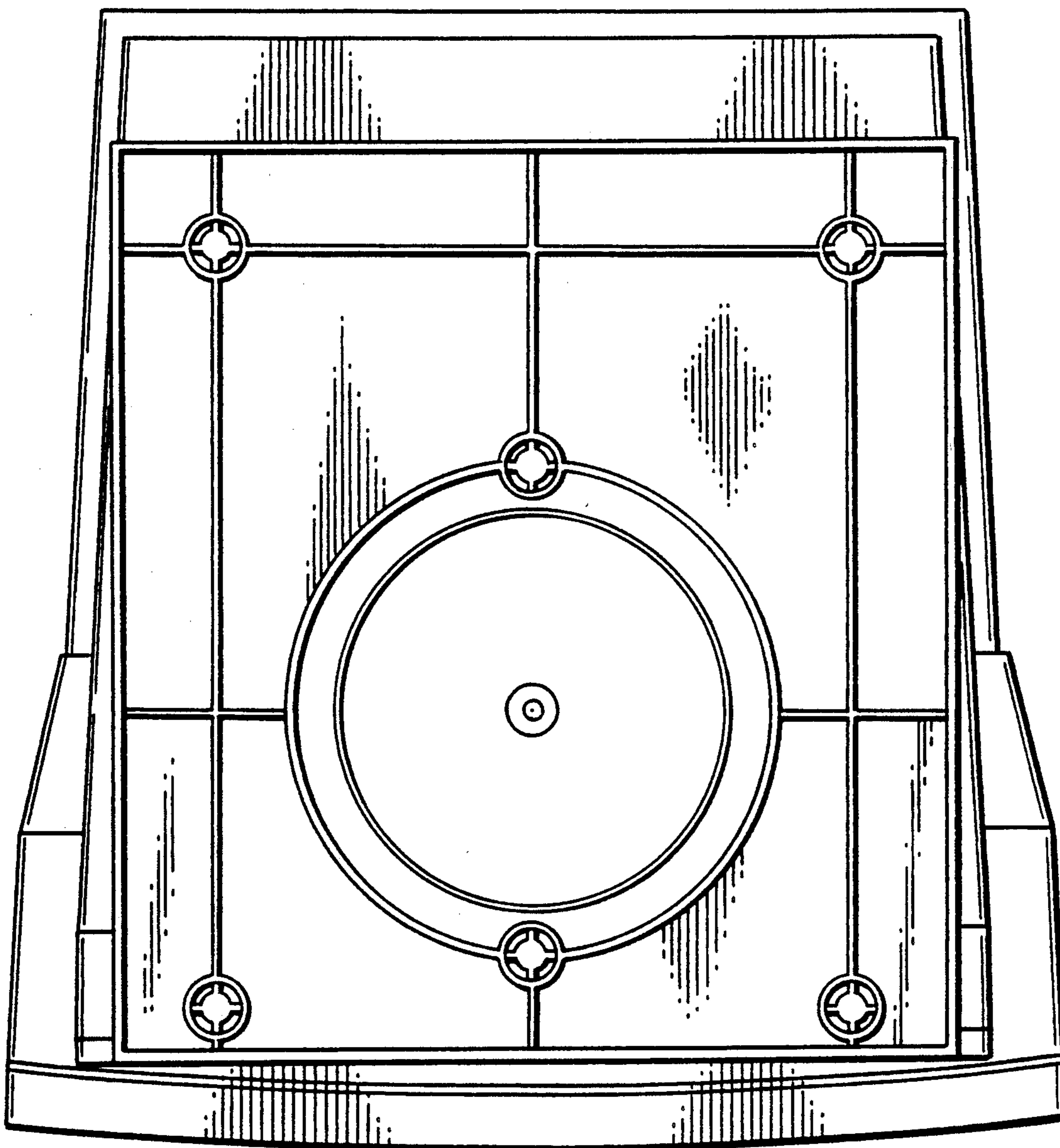

FIG. 6



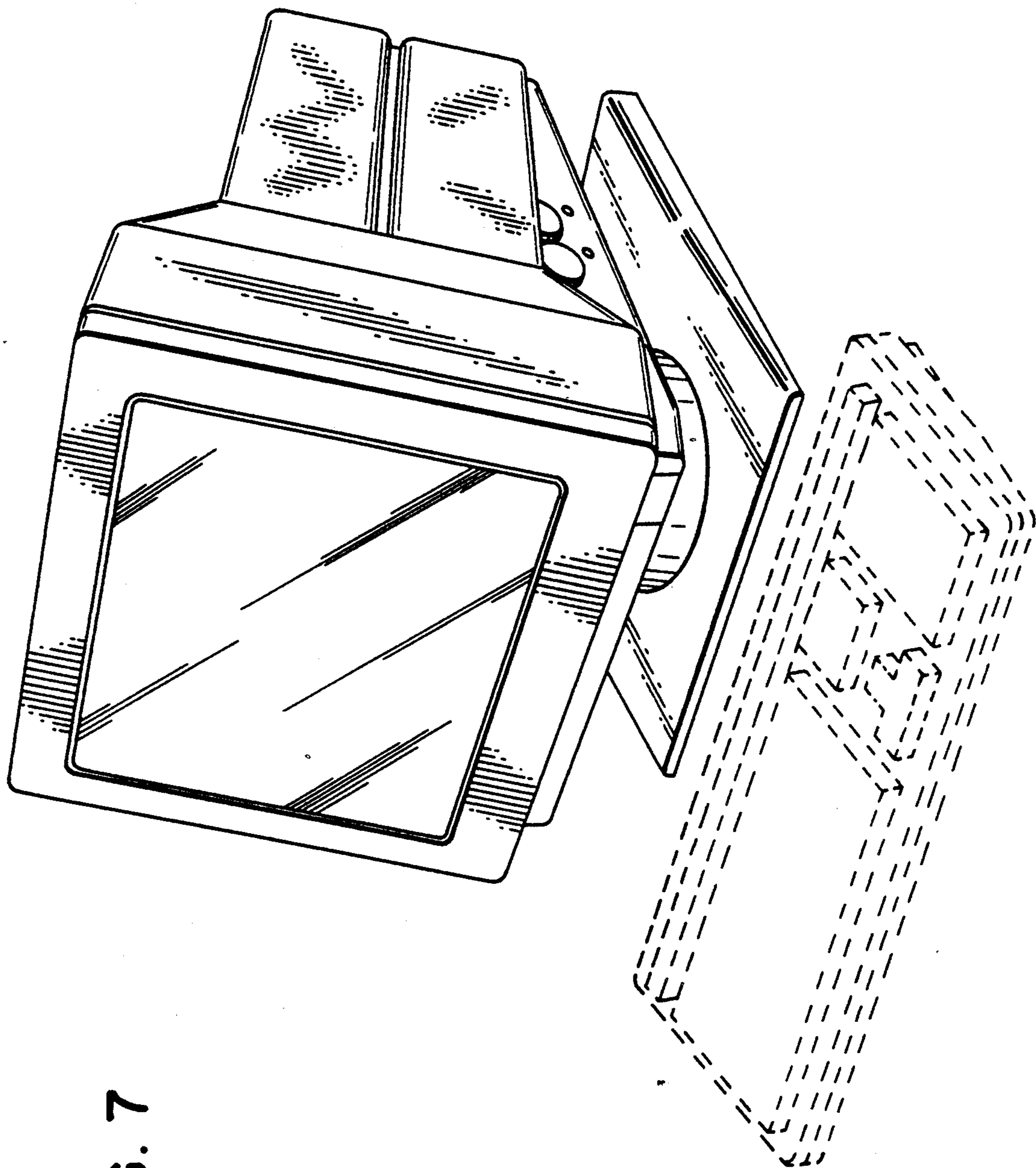

FIG. 7