

[54] **FOOD MIXER**

[75] **Inventor: Stuart Naft, Stratford, Conn.**

[73] **Assignee: Black & Decker, Inc., Newark, Del.**

[**] **Term: 14 Years**

[21] **Appl. No.: 236,137**

[22] **Filed: Aug. 25, 1988**

[52] **U.S. Cl. D7/379**

[58] **Field of Search D7/384, 412-415,
D7/379, 386, 376, 377, 380**

[56] **References Cited**

U.S. PATENT DOCUMENTS

- D. 189,306 11/1960 Willman D7/412
- D. 189,936 3/1961 Grange D7/379
- D. 195,424 6/1963 Cabell D7/379

- D. 279,858 7/1985 Janssens D7/412
- D. 291,271 8/1987 Wilson D7/379

*Primary Examiner—Winifred E. Herrmann
Attorney, Agent, or Firm—Barry E. Deutsch*

[57] **CLAIM**

The ornamental design for a food mixer, as shown and described.

DESCRIPTION

FIG. 1 is a right side elevational view of a food mixer showing my new design;
FIG. 2 is a left side elevational view;
FIG. 3 is a front elevational view;
FIG. 4 is a rear elevational view;
FIG. 5 is a top plan view; and
FIG. 6 is a top, rear, and left side perspective view thereof.

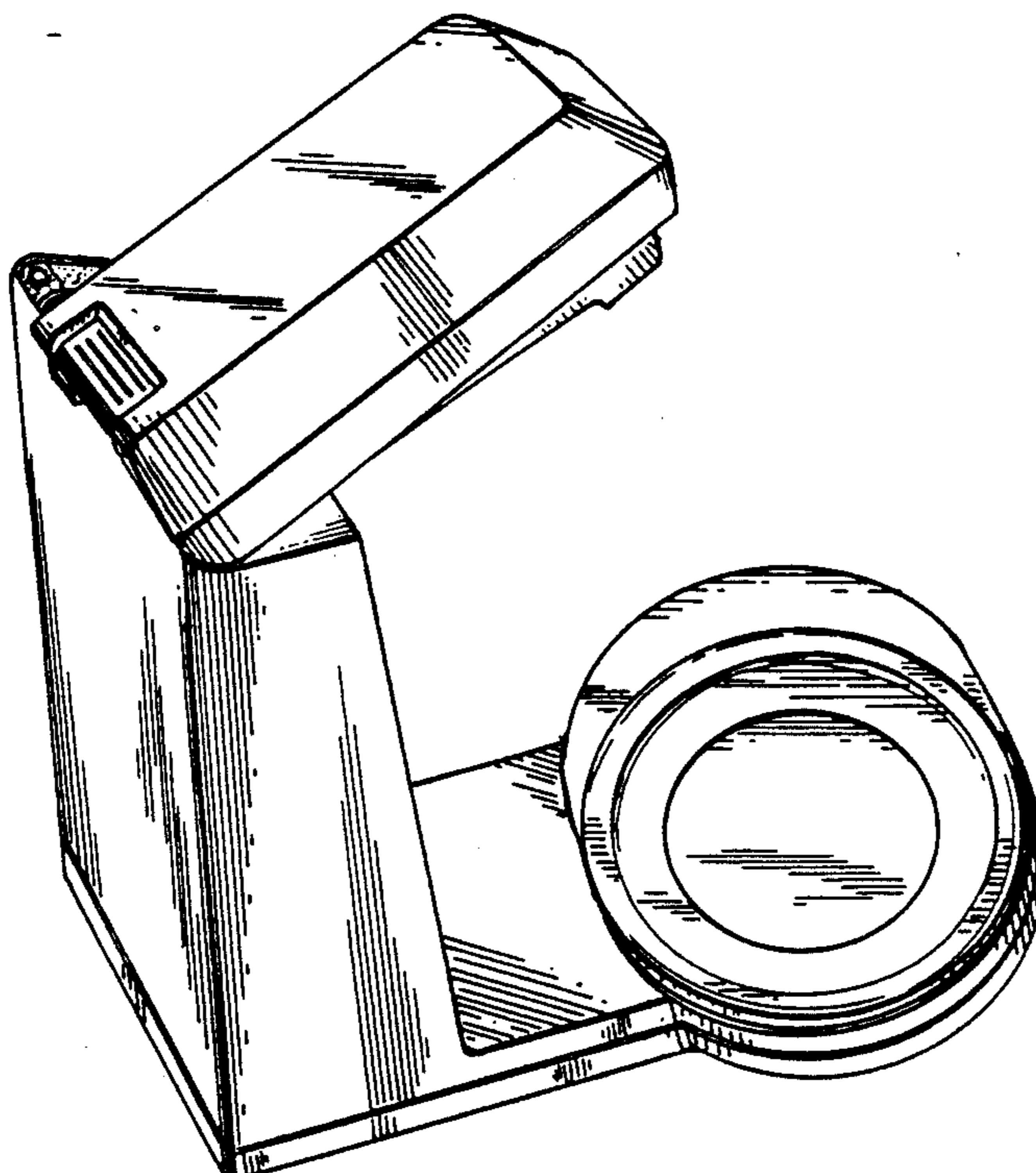
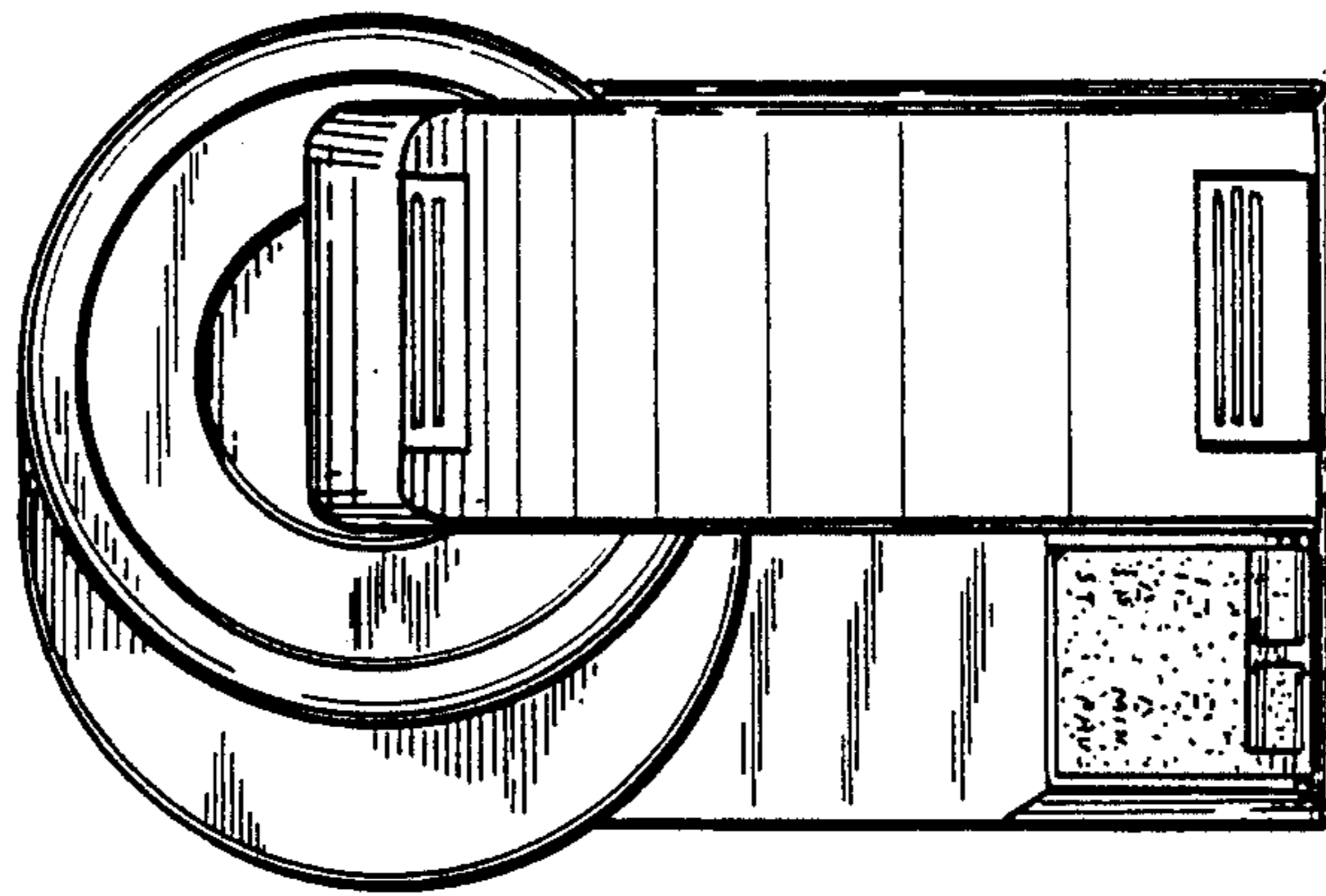

FIG. 1

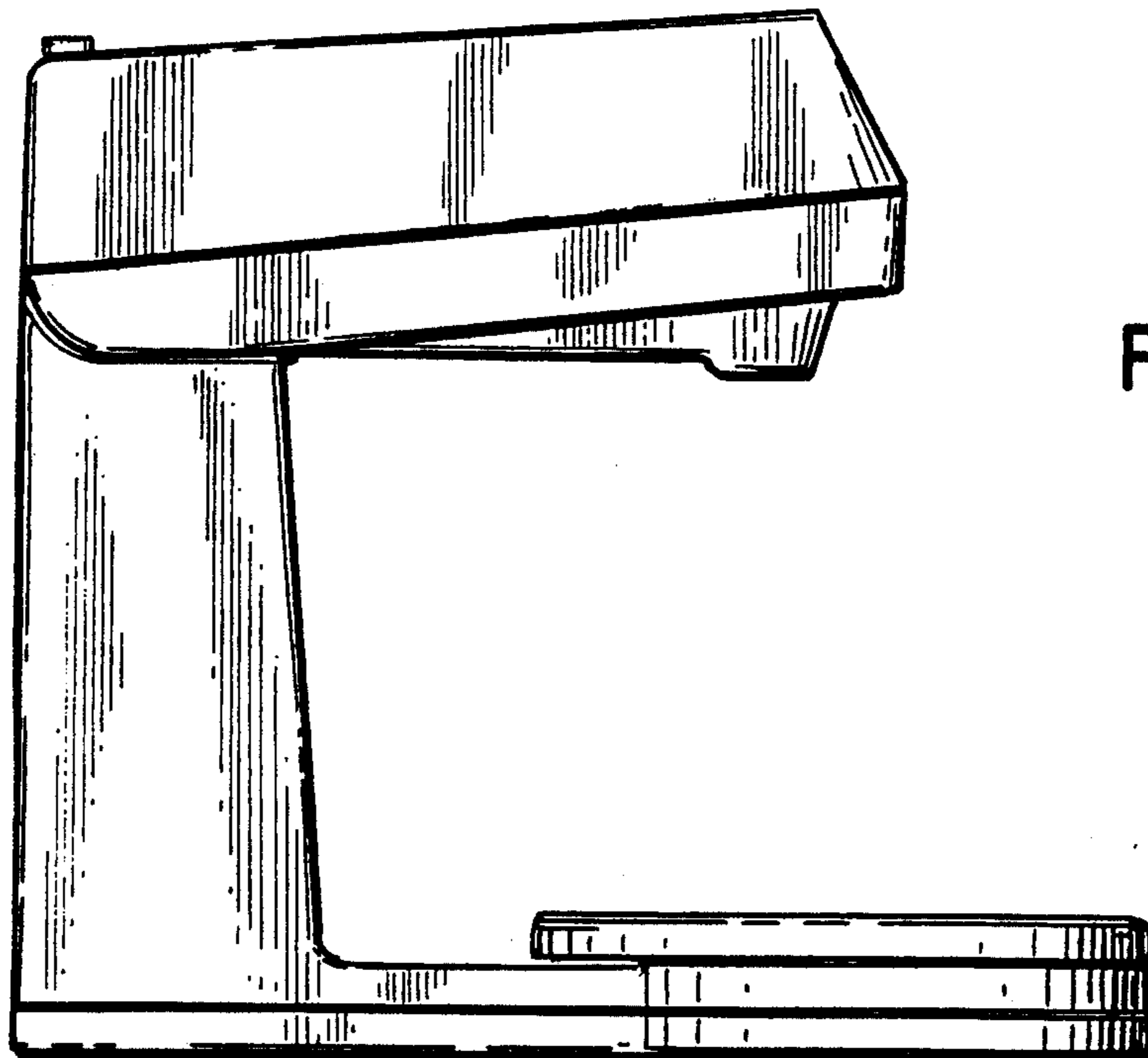
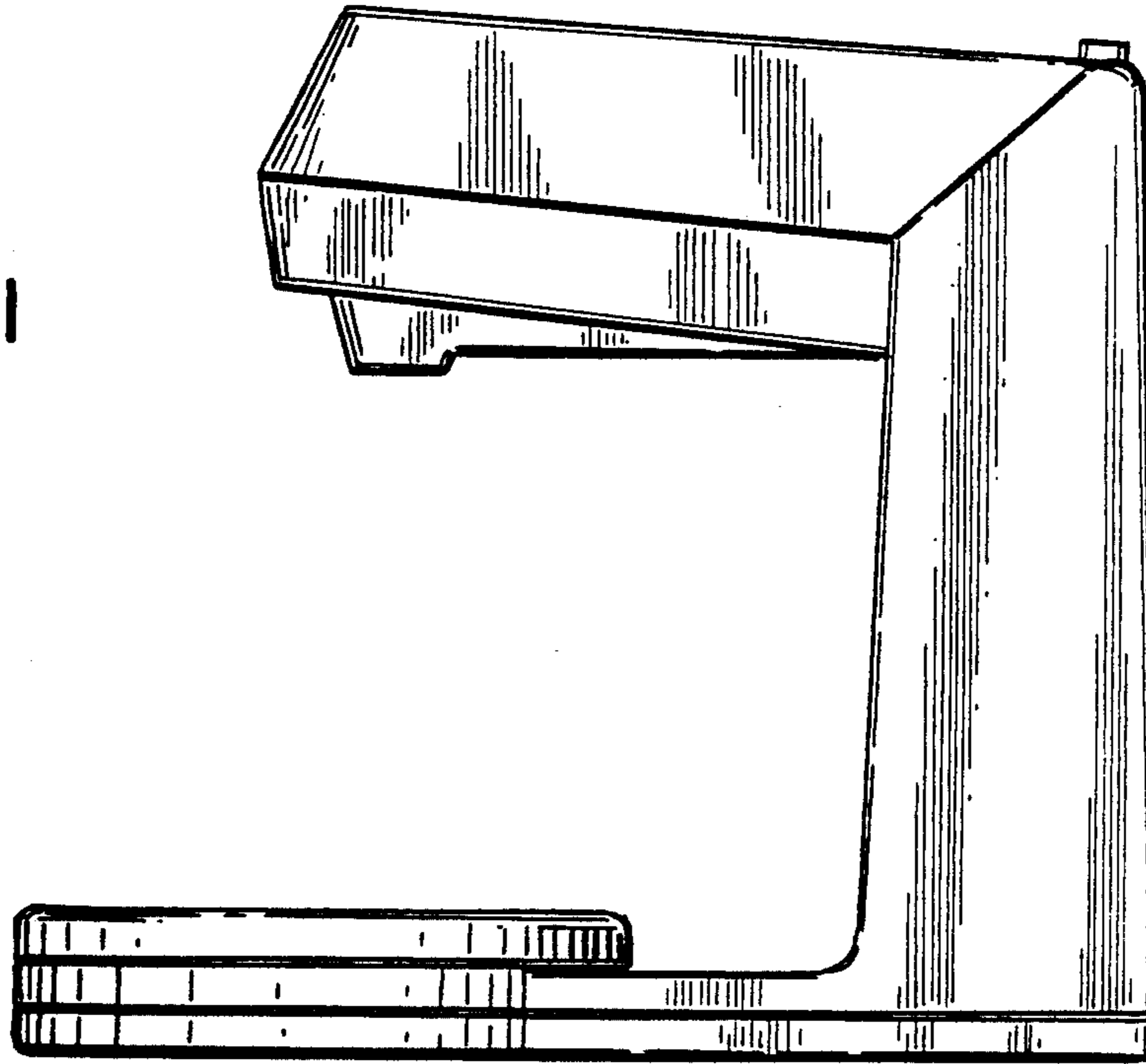

FIG. 2

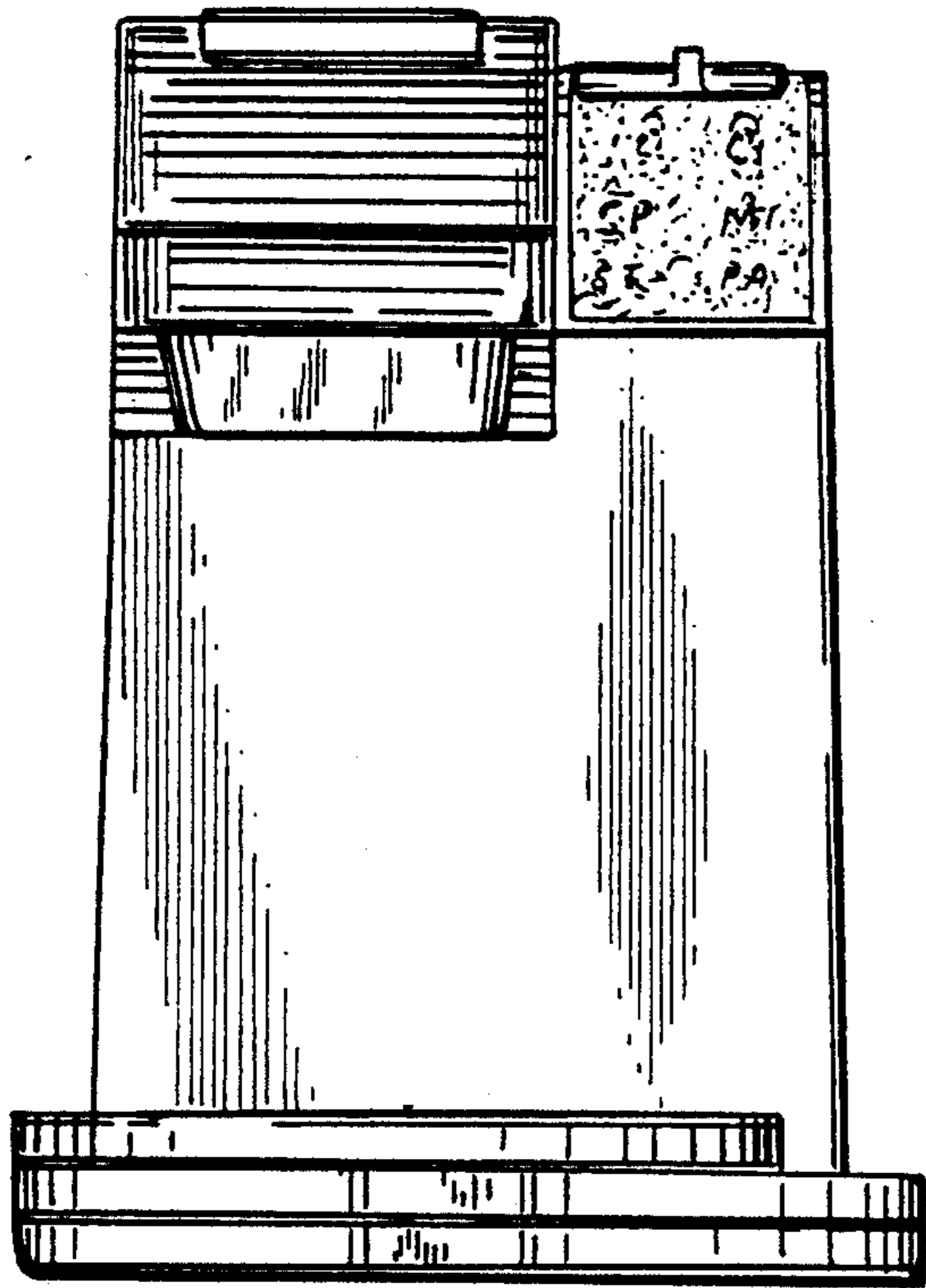

FIG. 3

FIG. 4

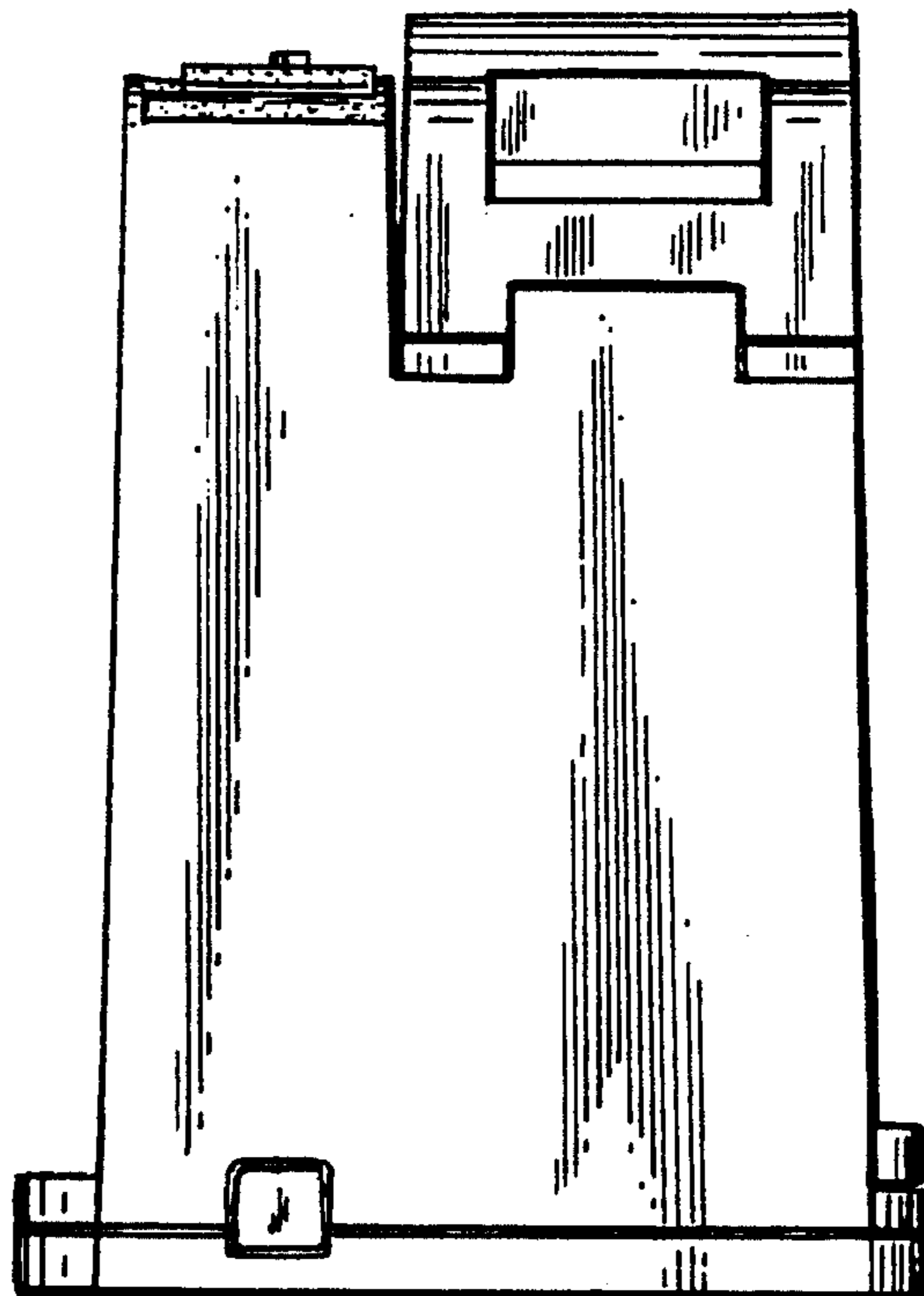

FIG. 5

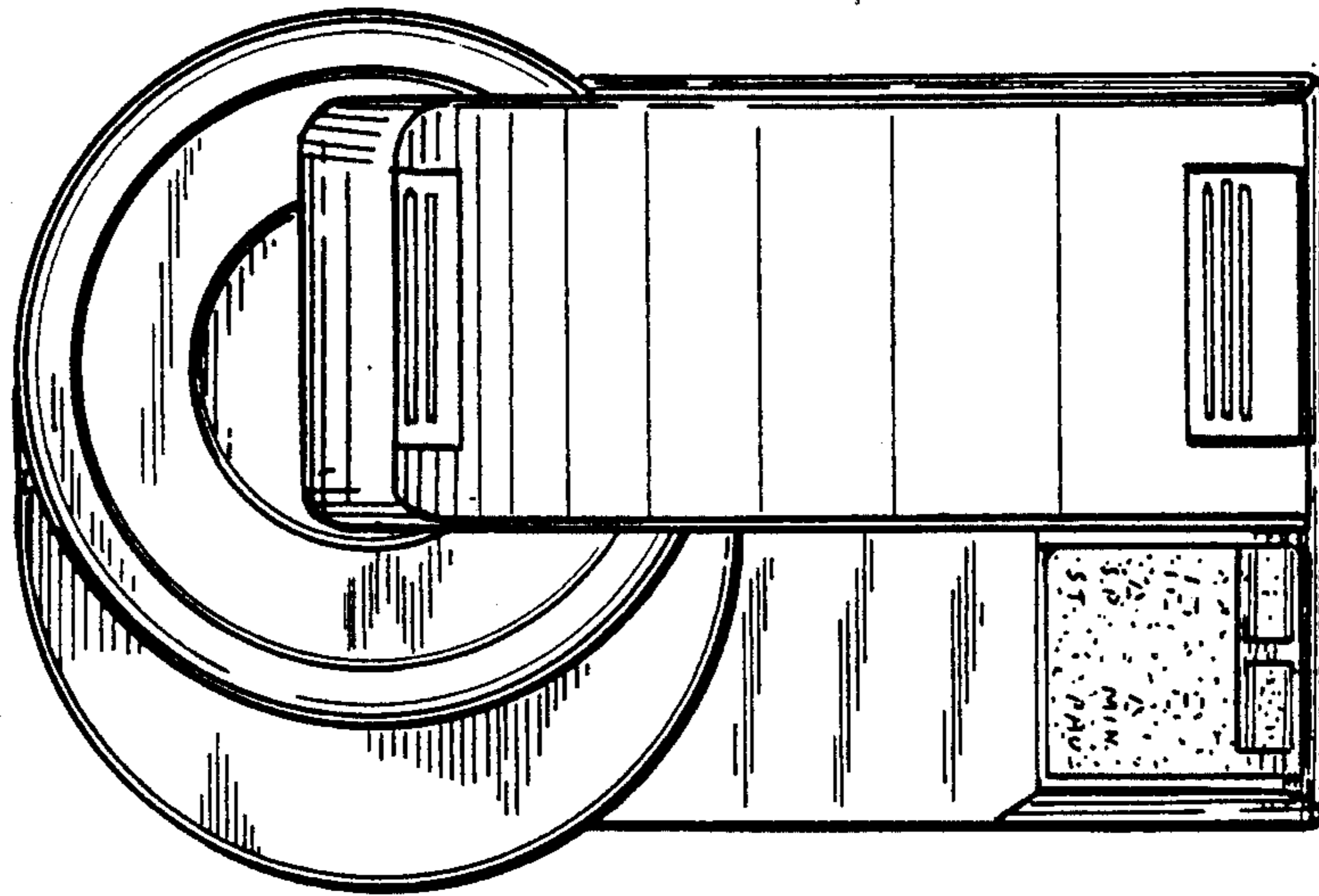

FIG. 6

