

[54] CIGAR CUTTER

[75] Inventor: Xavier Rousseau, Paris, France
[73] Assignee: S. T. Dupont S.A., Paris, France
[**] Term: 14 Years
[21] Appl. No.: 293,510
[22] Filed: Jan. 4, 1989

[30] Foreign Application Priority Data

Jul. 5, 1988 [FR] France 88 4370
[52] U.S. Cl. D27/195
[58] Field of Search D27/195; D7/693; D8/98,
D8/99, 105, 106; 131/233, 248-255;
30/109-113

[56] References Cited

U.S. PATENT DOCUMENTS

519,332 5/1894 Hopkins 30/113
1,119,220 12/1914 Bates 30/113

OTHER PUBLICATIONS

Nat Sherman Catalogue, Fall 1985, p. 26, cigar cutter, see item no. 17 PC far left hand side.

Primary Examiner—Wallace R. Burke
Assistant Examiner—H. Baynham

[57] CLAIM

The ornamental design for cigar cutter, as shown.

DESCRIPTION

FIG. 1 is a front elevational view of the cigar cutter, showing my new design;
FIG. 2 is a rear elevational view thereof;
FIG. 3 is a right side elevational view thereof;
FIG. 4 is a left side elevational view thereof;
FIG. 5 is a top plan view thereof;
FIG. 6 is a bottom plan view thereof;
FIG. 7 is a perspective view thereof;
FIG. 8 is a perspective view thereof, with the cutter raised.

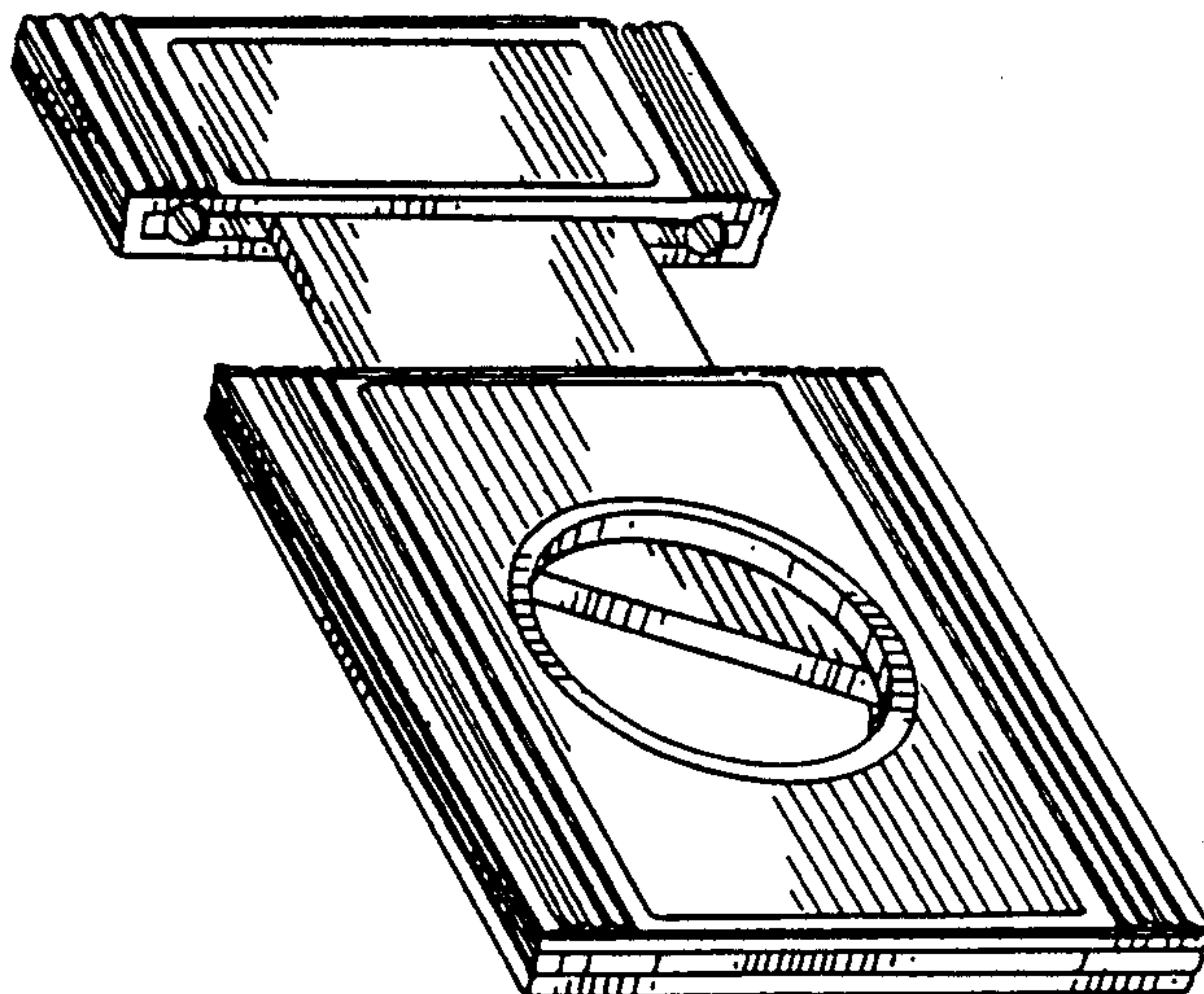
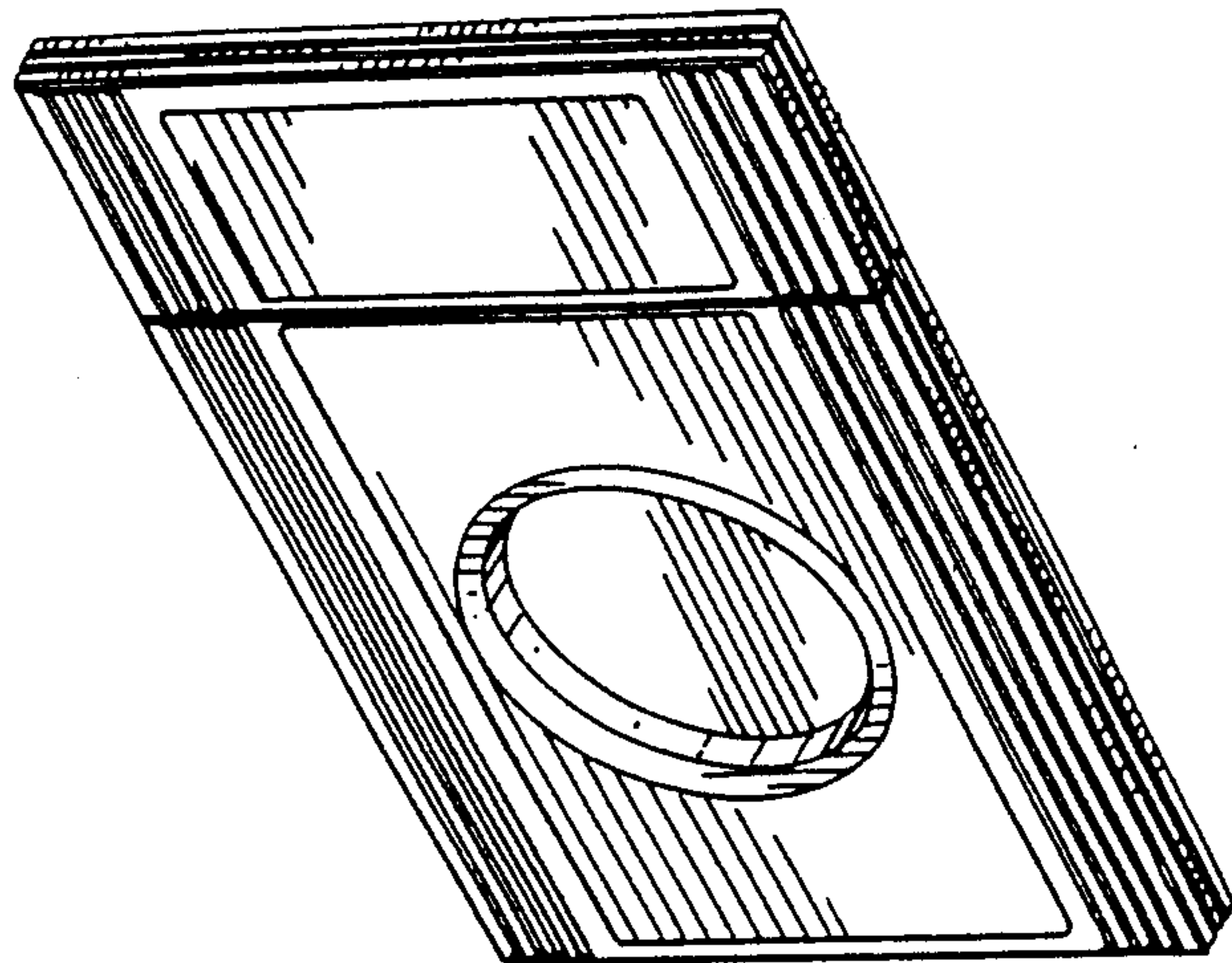

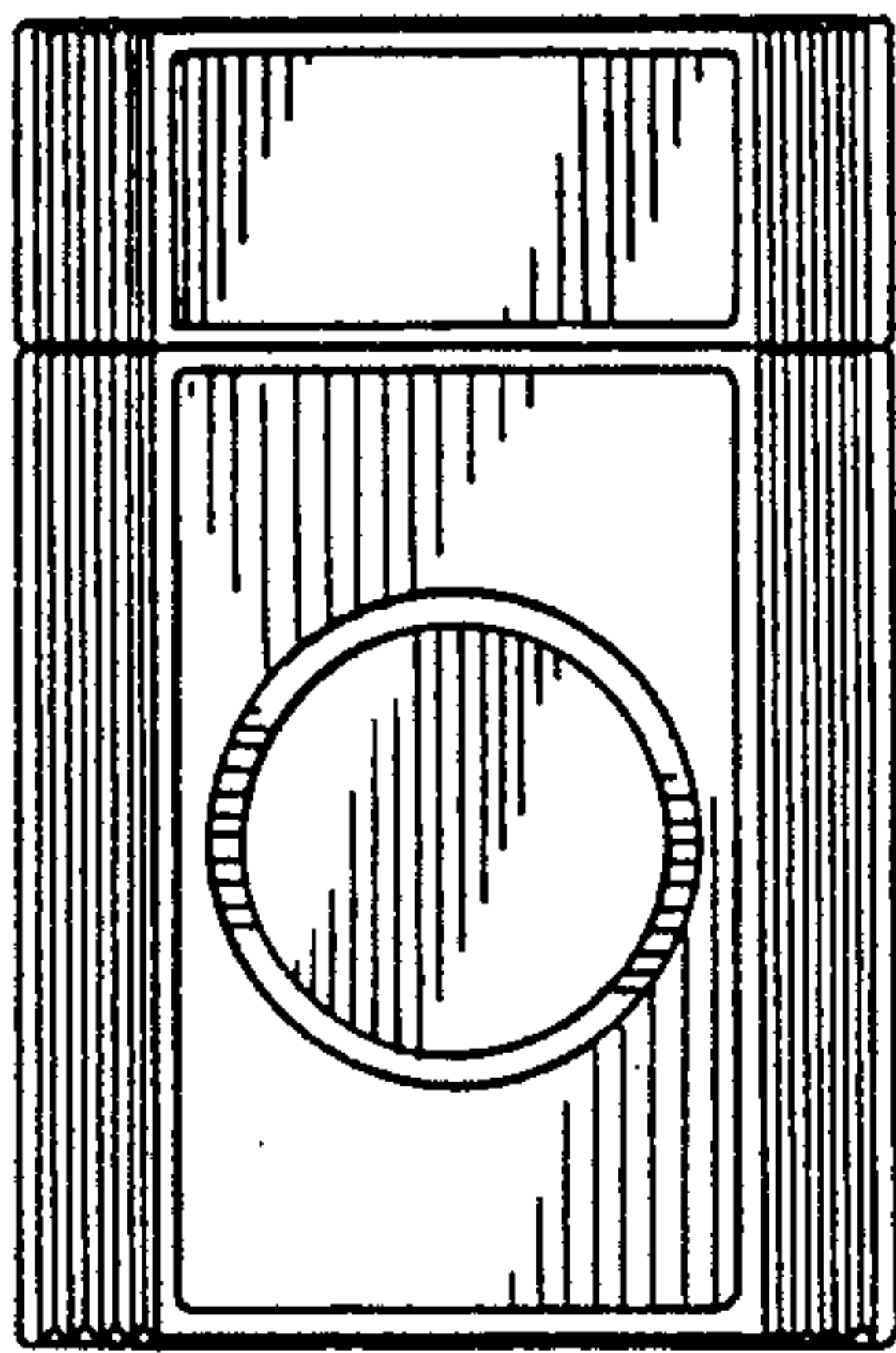

FIG. 1

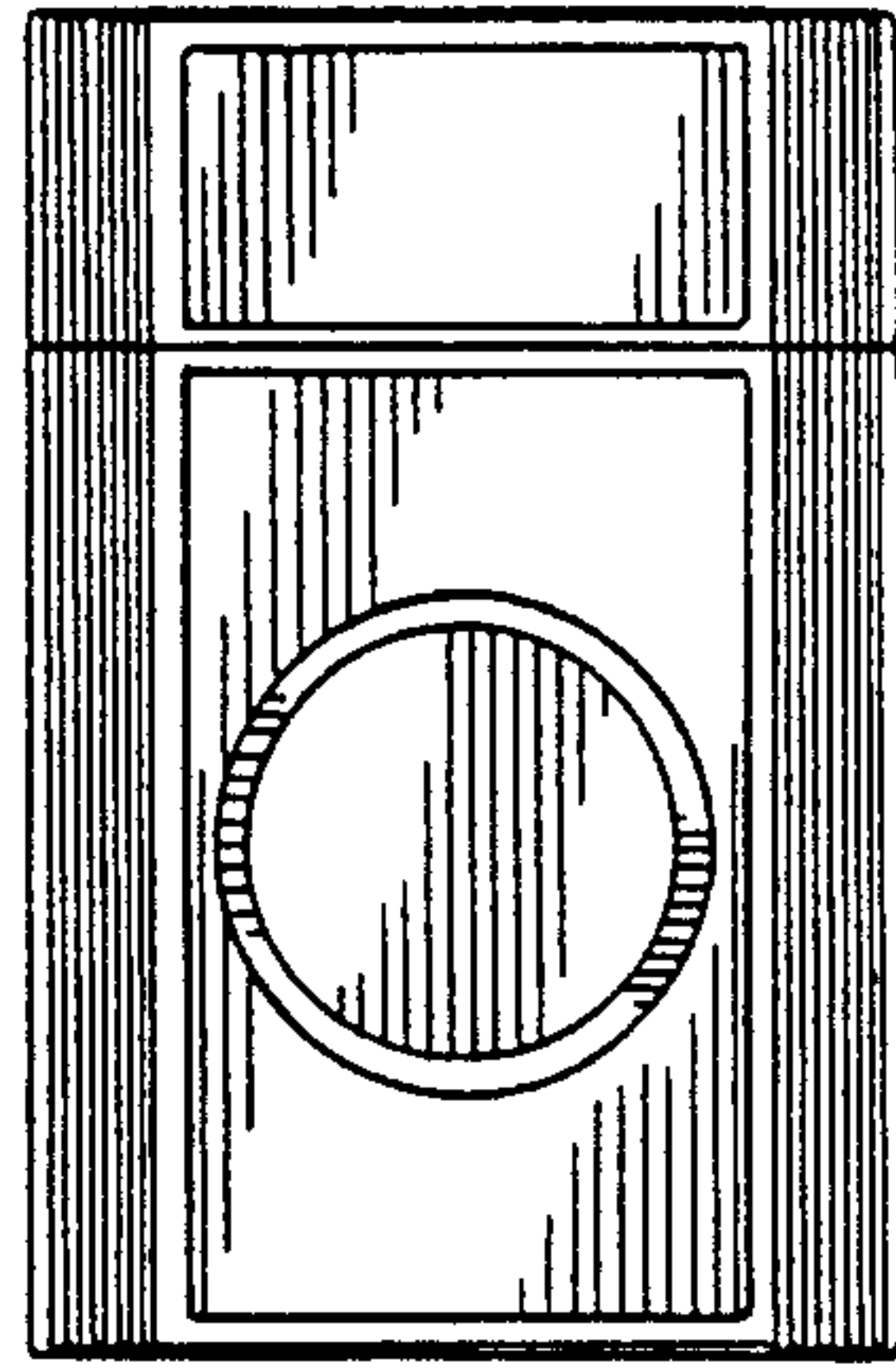

FIG. 2

FIG. 3



FIG. 5

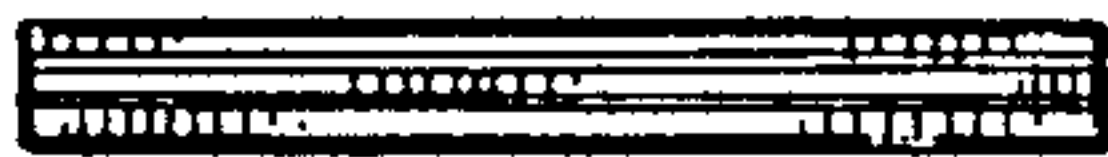

FIG. 4

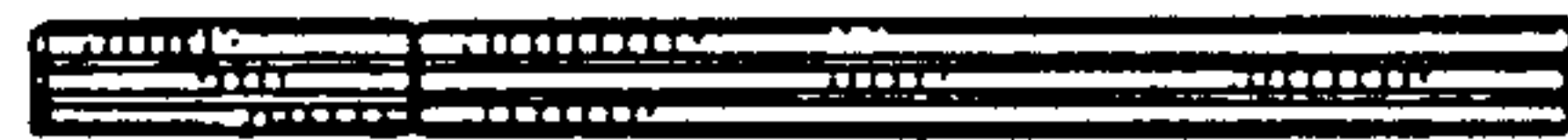

FIG. 6



FIG. 7

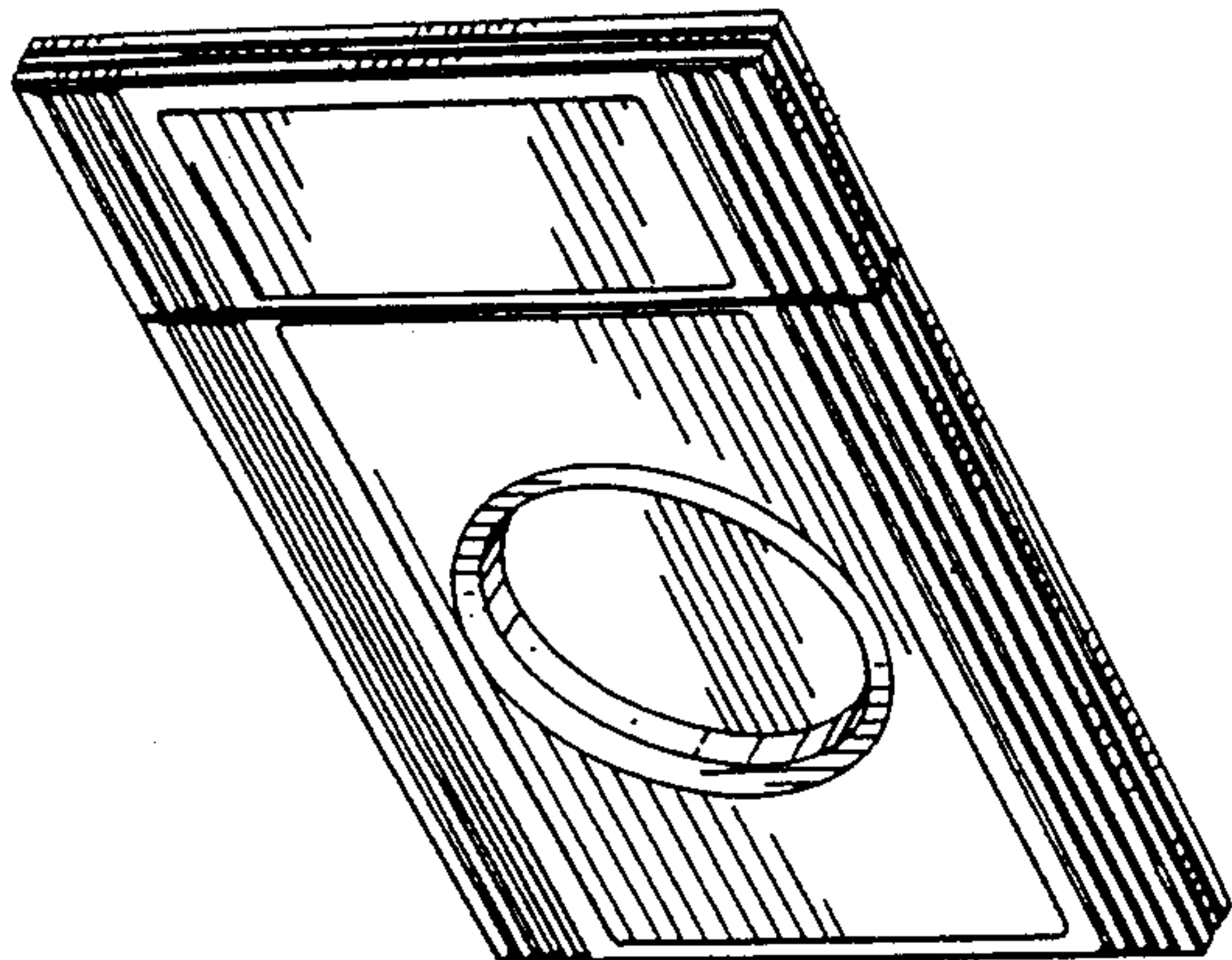

FIG. 8

