

[54] **BATHTUB OR THE LIKE**

[75] Inventors: Donald W. Doman, Janesville, Wis.; Paul P. Kolada, Bexley, Ohio; Todd D. Dannenberg, Sheboygan, Wis.

[73] Assignee: Kohler Co., Kohler, Wis.

[**] Term: 14 Years

[21] Appl. No.: 76,665

[22] Filed: Jul. 23, 1987

[52] U.S. Cl. D23/281

[58] Field of Search D23/275, 277-283, D23/303-307; 4/538, 546, 548, 553, 555, 556, 584, 589, 590, 596, 597, 598, 599-614

[56] **References Cited**

U.S. PATENT DOCUMENTS

D. 102,370	12/1936	Kohler et al.	D23/277
D. 103,482	3/1937	Callahan	D23/281
D. 129,821	10/1941	Kohler	D23/277
D. 181,166	10/1957	Schiffman	D23/306
D. 188,236	6/1960	Kohler	D23/277
D. 216,120	11/1969	Niemann et al.	D23/277
D. 225,739	1/1973	Seymour	D23/49
D. 230,851	3/1974	Chisholm	D23/277
D. 233,343	10/1974	Myers	D23/281
D. 243,181	1/1977	Stairs, Jr.	D23/281
D. 243,334	2/1977	Stairs, Jr.	D23/281
D. 255,262	6/1980	Beddome et al.	D23/281
D. 265,345	7/1982	Doman	D23/277 X
D. 278,844	5/1985	Stairs, Jr.	D23/277
D. 279,028	5/1985	Kohler, Jr. et al.	D23/55
D. 282,963	3/1986	Alger	D23/277

OTHER PUBLICATIONS

Owens-Corning ad entitled "Oval Bath," undated (admitted prior art), and pp. 6-7 of the 1986 Kohler Co. Plumbing Products catalog (admitted prior art). Pp. 6-35 and 6-37 of the 1986 Kohler Plumbing Products catalog (admitted prior art). Pp. 7-18, 7-10 and 7-12 of the Kohler Co. Plumbing Products catalog (admitted prior art) and an undated Hytec ad showing the "Ovation" (admitted prior art). Pp. 10-15 of the 1986 Kohler Co. Plumbing Products catalog (admitted prior art).

Primary Examiner—James R. Largen
Attorney, Agent, or Firm—Quarles & Brady

[57] **CLAIM**

The ornamental design for a bathtub of the like, as shown and described.

DESCRIPTION

FIG. 1 is a top perspective view of a bathtub or the like showing our new design; FIG. 2 is a top plan view thereof; FIG. 3 is a cross sectional view taken on line 3—3 of FIG. 2; FIG. 4 is a cross sectional view taken on line 4—4 of FIG. 2; and FIG. 5 is another top perspective view thereof. The fragmentary broken line representation of bathroom walls in FIGS. 1 and 5 and the broken line of an overflow opening in FIG. 4 and a bathtub skirt in FIG. 5 are for purposes of illustration only and form no part of the claimed design.

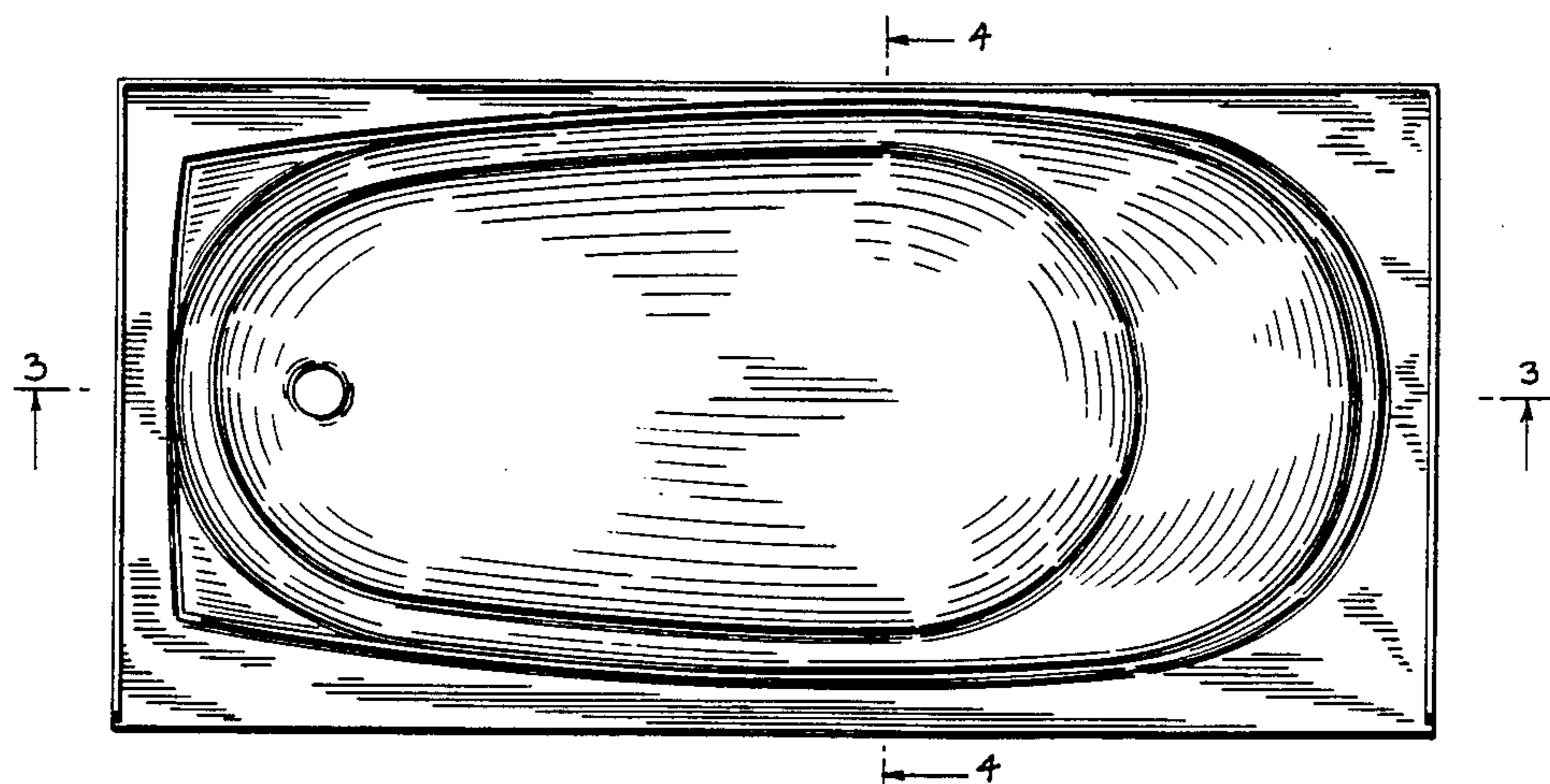
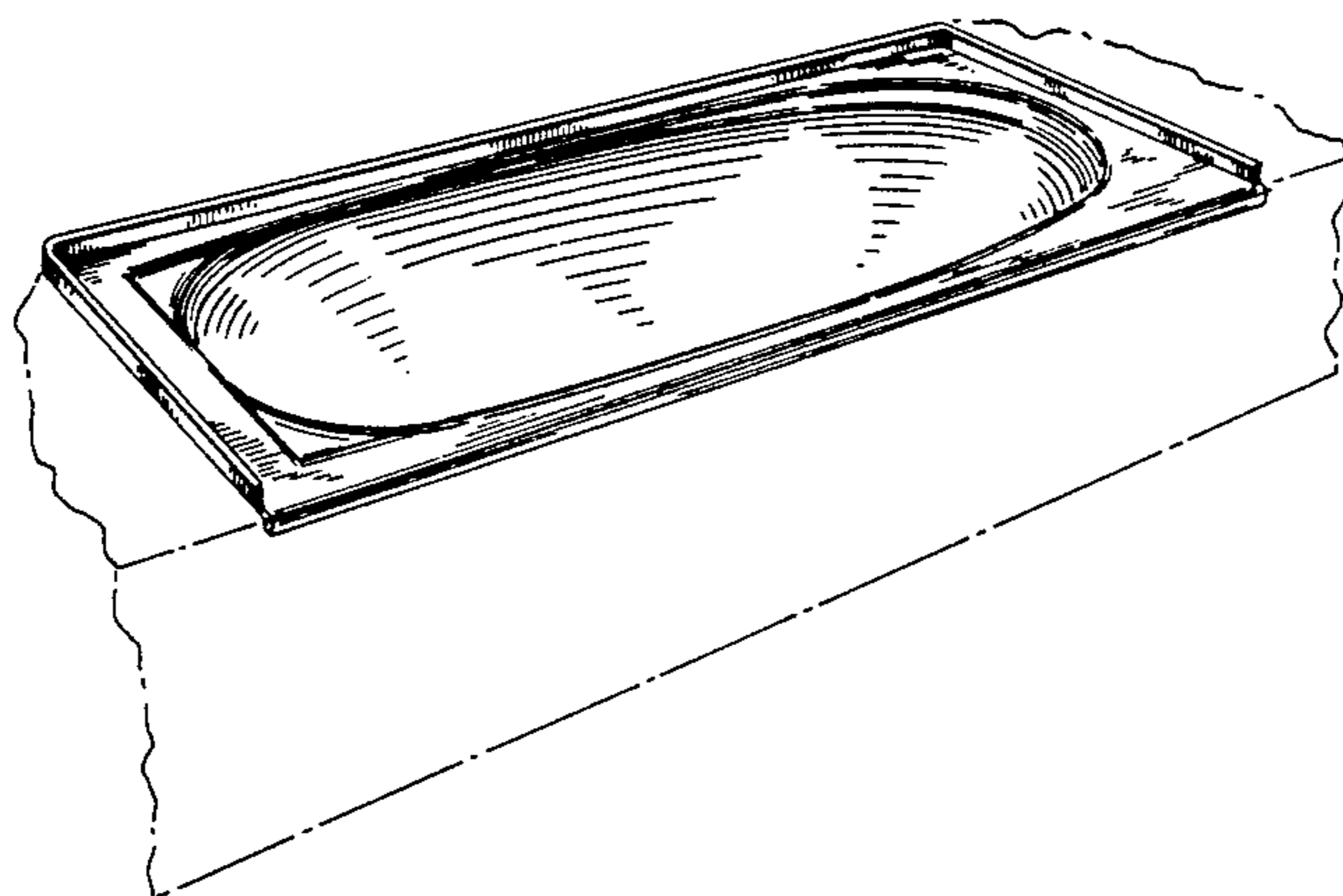

FIG. 1

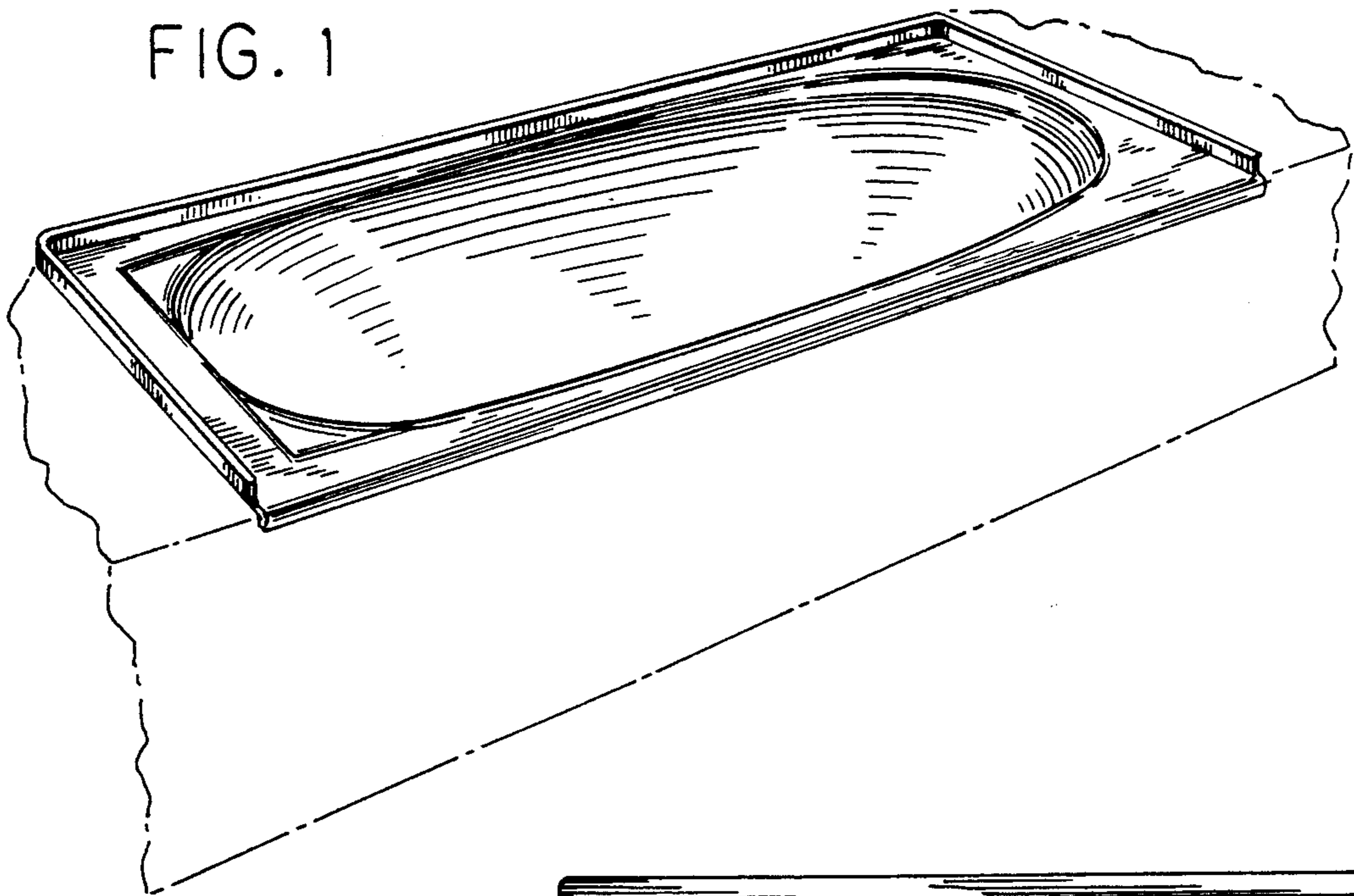

FIG. 4

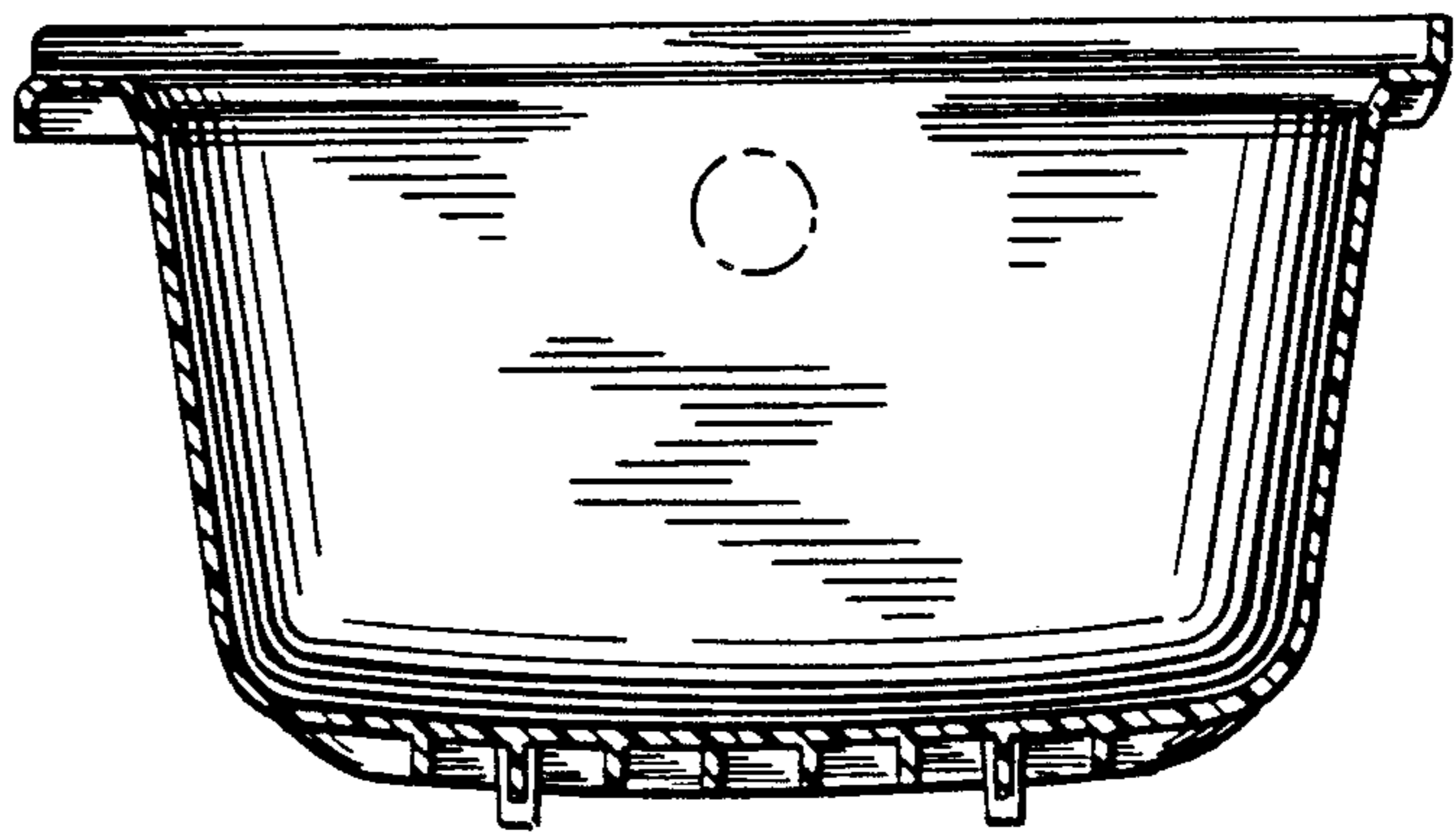
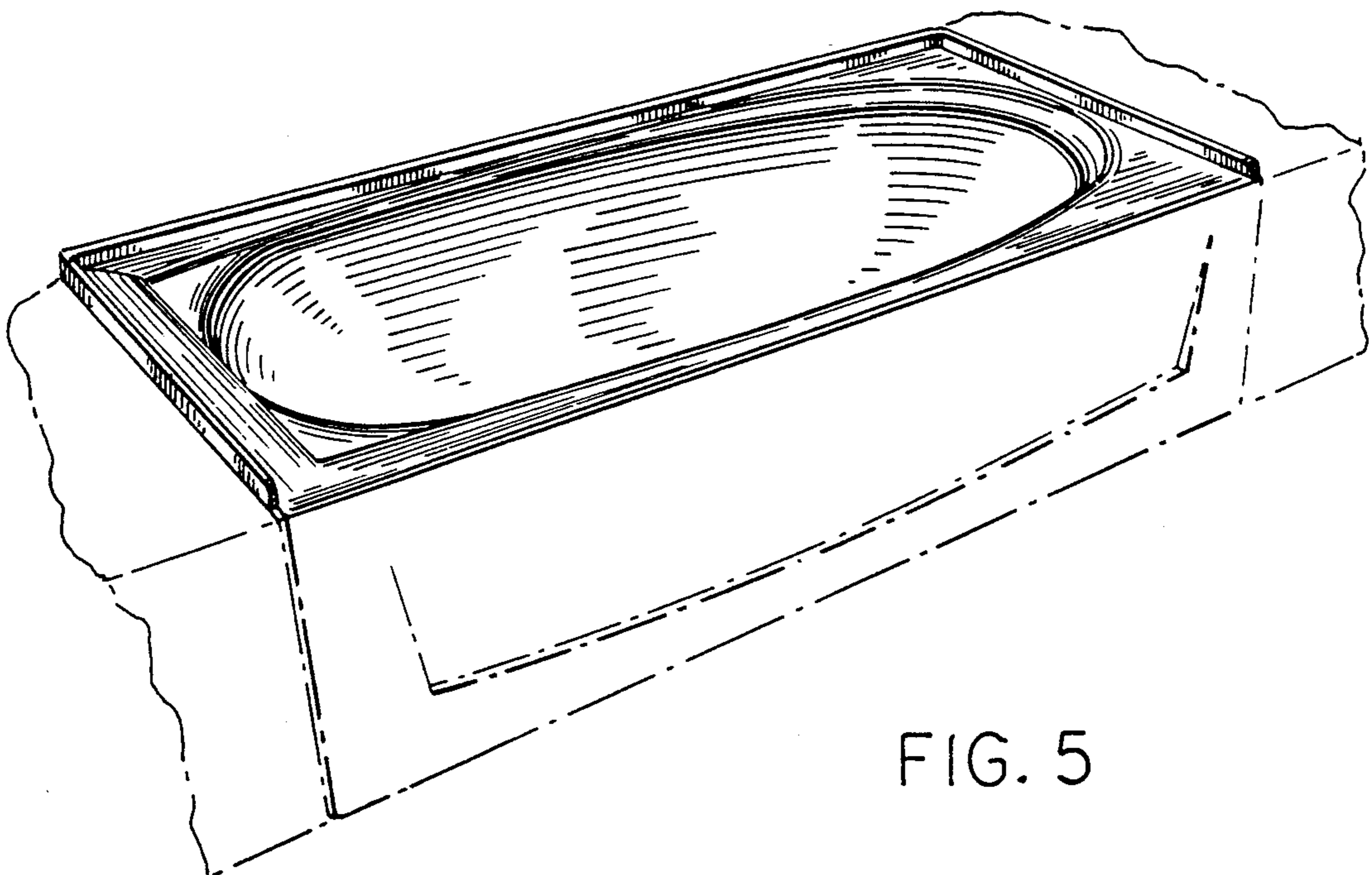

FIG. 5



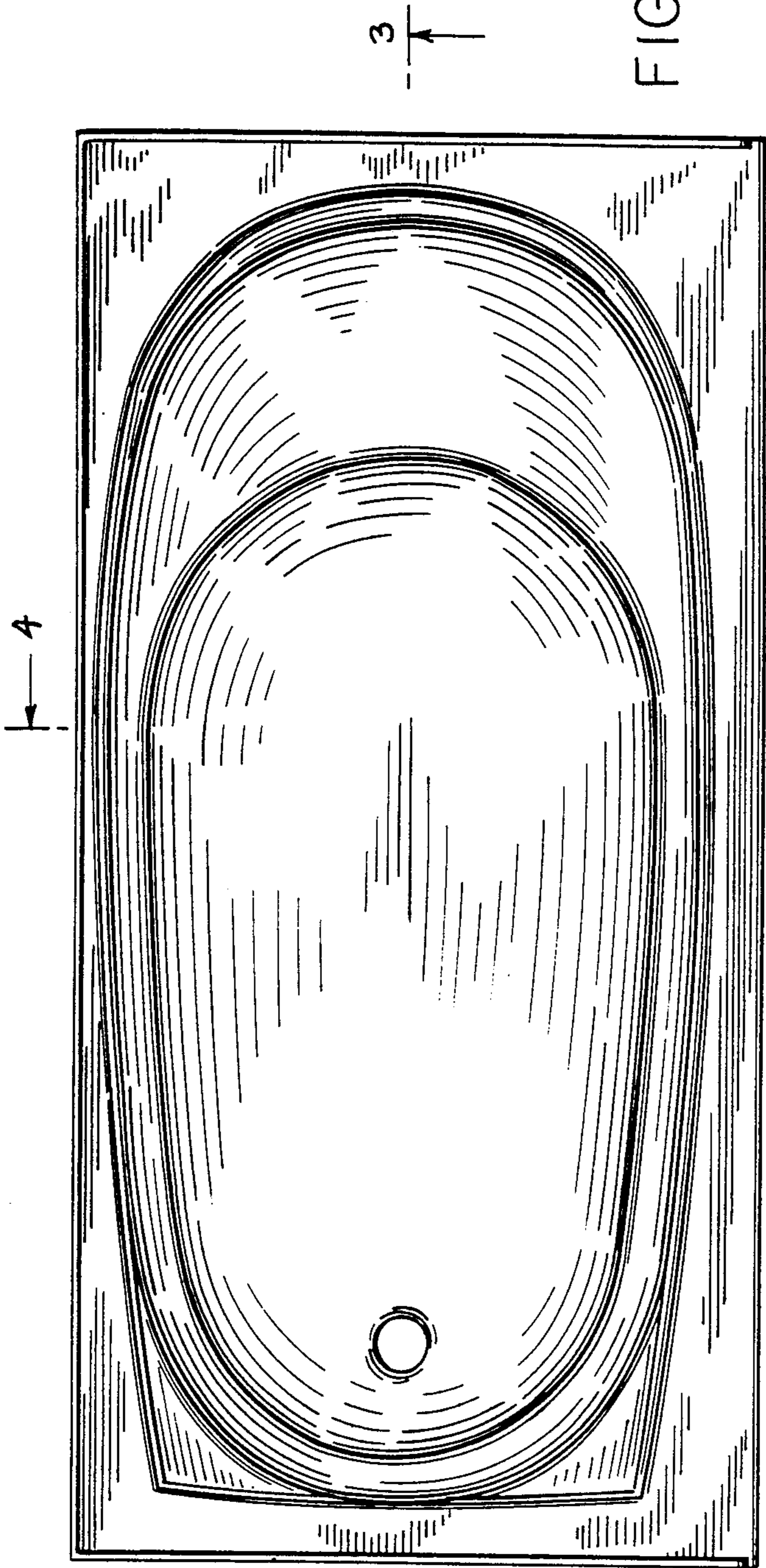

FIG. 2

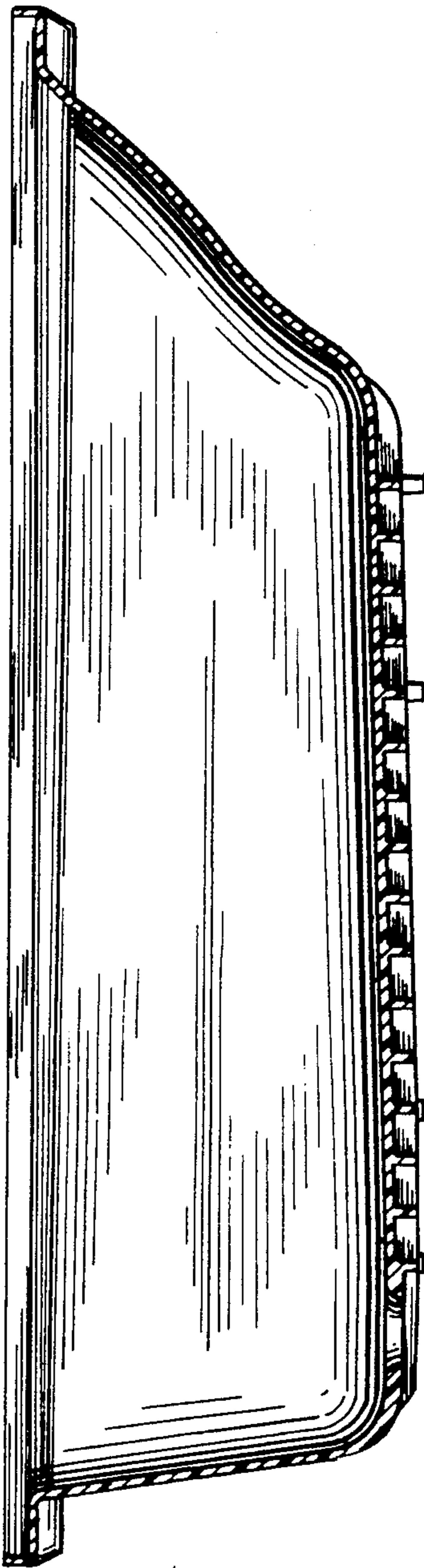

FIG. 3

UNITED STATES PATENT AND TRADEMARK OFFICE
CERTIFICATE OF CORRECTION

PATENT NO. : Des. 314,611
DATED : February 12, 1991
INVENTOR(S) : Doman et al.

It is certified that error appears in the above-identified patent and that said Letters Patent is hereby corrected as shown below:

In The Claim: "bathtub of the like" should read
--bathtub or the like--

**Signed and Sealed this
Fourth Day of August, 1992**

Attest:

DOUGLAS B. COMER

Attesting Officer

Acting Commissioner of Patents and Trademarks