

[54] **ELECTRONIC COMPUTER**

[75] **Inventor: Masaaki Iino, Yokohama, Japan**

[73] **Assignee: Kabushiki Kaisha Toshiba, Kanagawa, Japan**

[**] **Term: 14 Years**

[21] **Appl. No.: 234,837**

[22] **Filed: Aug. 22, 1988**

[30] **Foreign Application Priority Data**

Feb. 25, 1988 [JP] Japan 63-7192

[52] **U.S. Cl. D14/106**

[58] **Field of Search D14/100, 101, 106, 113, D14/115; D18/1, 7, 11, 12; 235/145 A, 145 R; 340/700, 706, 711, 712; 341/22, 23; 358/249, 254; 364/706-710; 400/489, 492; 312/7.2, 208**

[56] **References Cited**

U.S. PATENT DOCUMENTS

- D. 221,002 6/1971 Bachman .
- D. 222,472 10/1971 Jacobson .
- D. 224,784 7/1972 Sucre et al. .
- D. 247,563 3/1978 Jinbo et al. .
- D. 254,005 1/1980 Reid et al. D14/106
- D. 258,957 4/1981 Bevilacqua et al. .
- D. 275,102 8/1984 MacConnel D14/106
- D. 280,511 9/1985 Moggridge et al. .
- D. 282,843 3/1986 Kurihara et al. D14/100
- D. 283,511 4/1986 Dunn D14/106
- D. 284,193 6/1986 Marshall D14/101
- D. 284,474 7/1986 Sawada D14/100
- D. 287,969 1/1987 Kusanagi D14/106
- D. 288,566 3/1987 Chin et al. .
- D. 289,177 4/1987 Sawada D18/7
- D. 289,763 5/1987 Fujii et al. D14/106
- D. 290,256 6/1987 Sapper D14/106
- D. 290,845 7/1987 Yubisui et al. D14/111
- D. 291,442 8/1987 Kurihara D14/106
- D. 293,677 1/1988 Hara et al. D14/106
- D. 293,678 1/1988 Sawatani et al. D14/106
- D. 294,029 2/1988 Nishiyama et al. D14/106
- D. 294,831 3/1988 Hara et al. D14/106
- D. 295,176 4/1988 Nishimoto et al. D14/106
- D. 299,031 12/1988 Sugano D14/106
- D. 303,523 9/1989 Shiozawa et al. D14/106

FOREIGN PATENT DOCUMENTS

- 100708 6/1988 China .
- 100709 6/1988 China .
- 100093 7/1988 China .
- GG85 300416 5/1986 European Pat. Off. .
- 47-14961 5/1972 Japan .
- 499866 4/1979 Japan .
- 590253 12/1982 Japan .
- 599666 4/1983 Japan .
- 650470 5/1985 Japan .
- 664175 10/1985 Japan .
- 684172 8/1986 Japan .
- 685000 8/1986 Japan .
- 685063 8/1986 Japan .
- 685121 8/1986 Japan .
- 685733 8/1986 Japan .
- 686374 9/1986 Japan .
- 686381 9/1986 Japan .
- 686386 9/1986 Japan .
- 686706 9/1986 Japan .
- 685000 12/1986 Japan .
- 695931 12/1986 Japan .
- 696188 1/1987 Japan .
- 697328 1/1987 Japan .
- 67297 2/1987 Rep. of Korea .
- 85-2546 1/1987 Sweden .
- 85-2547 1/1987 Sweden .

OTHER PUBLICATIONS

- Computer Products-1986 p. 25-Toshiba Portable Personal Computer.
- New York Times-Dec. 23, 1987 p. D4-Nec Portable Computer.
- Sharp "Character Display" Article 05/18/76.
- Fanuc System P-Model 07/27/83.
- Moebel Interior Design 01/05/84.
- Micro Office Systems "Road Runner" 01/31/84.
- Demus 645 02/22/84.
- Design 423 05/08/84.
- Epson HC-88 07/01/84.
- Apple Computer 10/15/84.
- Tandy 200 00/00/85.
- General Corporation 4400 01/14/85.
- Drawing J60007802 02/26/85.
- Aval TM 20 03/08/85.
- C & D News 03/29/85.
- Hewlett-Packard HP110 04/00/85.

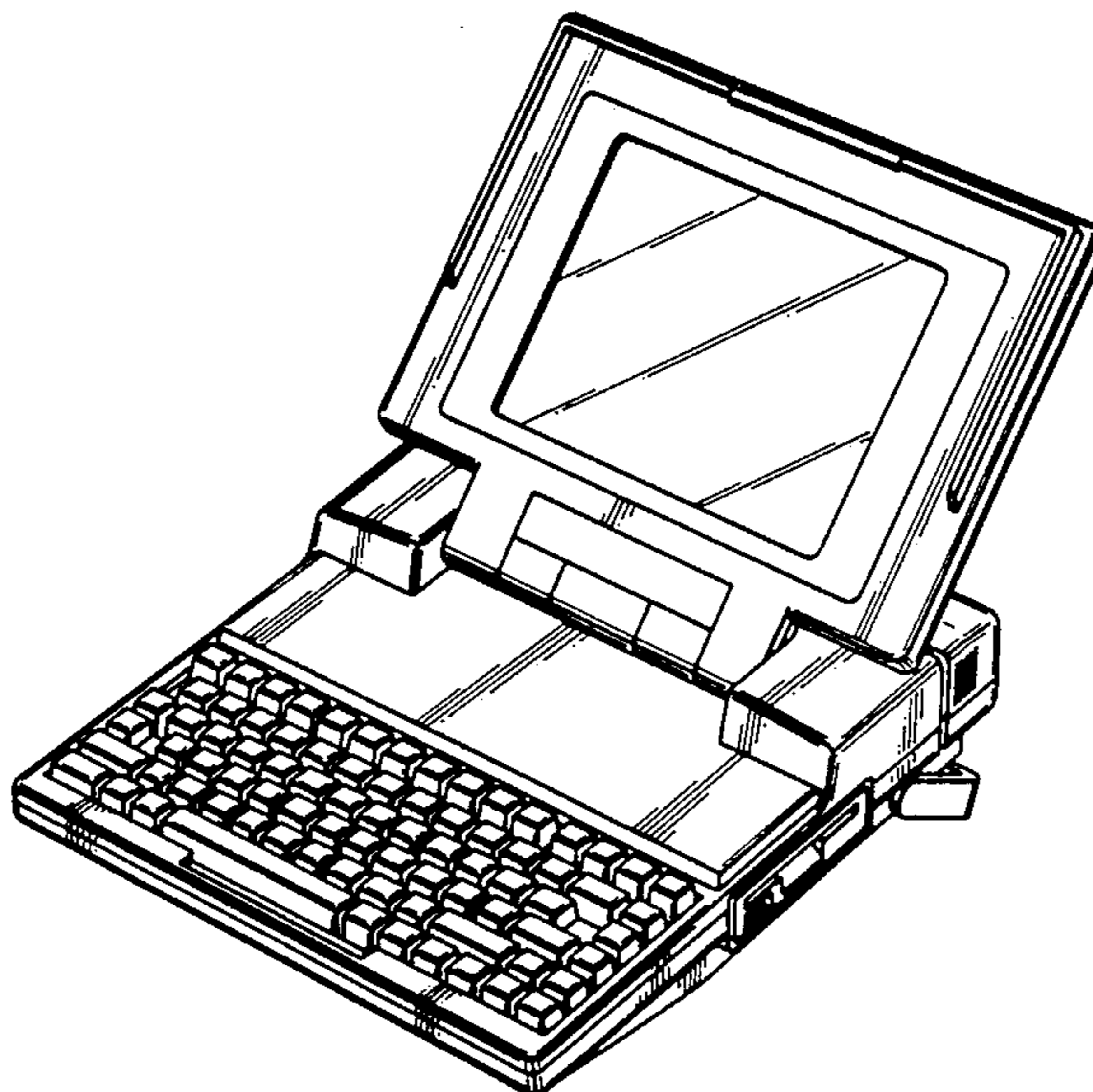

Sharp PC5000 04/00/85.
 Toshiba T1100 Plus 07/22/85.
 Minato Electronics MODS-5000 08/22/85.
 Hewlett-Packard Portable Plus 12/00/85.
 Apple IIC 12/00/85.
 Fuji Line Motor Monitor FLM 700 01/31/86.
 MRD Advertisement.
 Gavilan Mobile Computer Brochure.
 Hewlett-Packard Advertisement.
 Hewlett-Packard Advertisement.
 Hitachi Advertisement.
 Sharp PC-5000 Brochure.
 Data General One Advertisement.
 IS-11c Advertisement.
 Fujitsu Computer Advertisement.
 IBM Advertisement.
 Aval TM Advertisement.
 Nec Starlet PC-8401A Brochure.
 FBS Advertisement.
 IBM Advertisement.
 PC-816F Advertisement.
 Zenith Data Systems Newsdate Newsletter 06-07/86.
 Tandy 600 Advertisement.
 Ricoh JP70D Brochure.
 Data General One Brochure.
 Article re IBM Portable Personal Computer.
 NEC PC-98LT Advertisement.
 Yaskawa P-t50 Advertisement.
 Yaskawa Memocon ®-SC GL20 Advertisement.
 TI Advertisement in Telephony.
 Data General One Model 2J Brochure.
 Ricoh Mr. Mytool LX Advertisement.
 Hitachi B16LX Brochure.
 Ricoh Brochure.
 Sony Product 100 Brochure.
 Panasonic FW-U1EX Advertisement.
 NEC Minitel 5 Advertisement.
 IBM 5540/5535 Brochure.
 NEC PC-9800 Advertisement.
 Panasonic U1EX Advertisement.
 Panasonic U1Pro.
 Sanyo MBC-16LT Personal Computer Advertisement.
 Diagnostic Products Review 01-02/88.
 Toshiba E&E News.
 Visual Computer Brochure.
 Gavilan Mobile Computer Brochure.

Olivetti Personal Computer M15 Brochure.
 Epson HC-88, HC80 Brochure.
 Epson PX-8 Personal Computer Brochure.
 Mitsubishi mp286L Laptop Personal Computer Brochure.
 Grid Brochure.
 Dauphin Laptop Computer Brochure.
 MicroDirect Brochure.
 SupersPort Brochure.
 Panasonic KX-D4930 Advertisement.
 Ampere WS-1 Advertisement.
 Tandy 200 Advertisement.
 NEC Starlet PC-8401A Advertisement.
 GRID, GridCase Computers-Catalog.
 Nippon Data General, Data General Catalog-May 23, 1985.
 Schneider, Multivision 300SLC, Catalog.
 Rein Elektronik, Catalog Laptop 300 SLC, 1977.
 Victor Technologies, Catalog-V 286 P.
 The Dempa Shim bun Newspaper-(Sep. 12, 1984) Hewlett Packard.
 The Nihon Keizai Shimbun, (Apr. 18, 1985) Fujitsu-Newspaper.
 Software Journal, vol. 1-No. 4, Texas Instruments Pro--Lite.
 Magnum's, Nov. 1984-Dulmont.

Primary Examiner—Wallace R. Burke
 Assistant Examiner—Freda S. Nunn
 Attorney, Agent, or Firm—Banner, Birch, McKie & Beckett

[57] CLAIM

The ornamental design for an electronic computer, as shown and described.

DESCRIPTION

FIG. 1 is a top, front, right side perspective view of the electronic computer showing my new design;
 FIG. 2 is a rear elevational view thereof;
 FIG. 3 is a top plan view thereof;
 FIG. 4 is a left side elevational view thereof;
 FIG. 5 is a bottom plan view thereof;
 FIG. 6 is a front elevational view thereof;
 FIG. 7 is a right side elevational view thereof.
 The display panel is shown in the closed position and the supporting leg is shown in the folded position in FIGS. 6 and 7.

FIG. 1

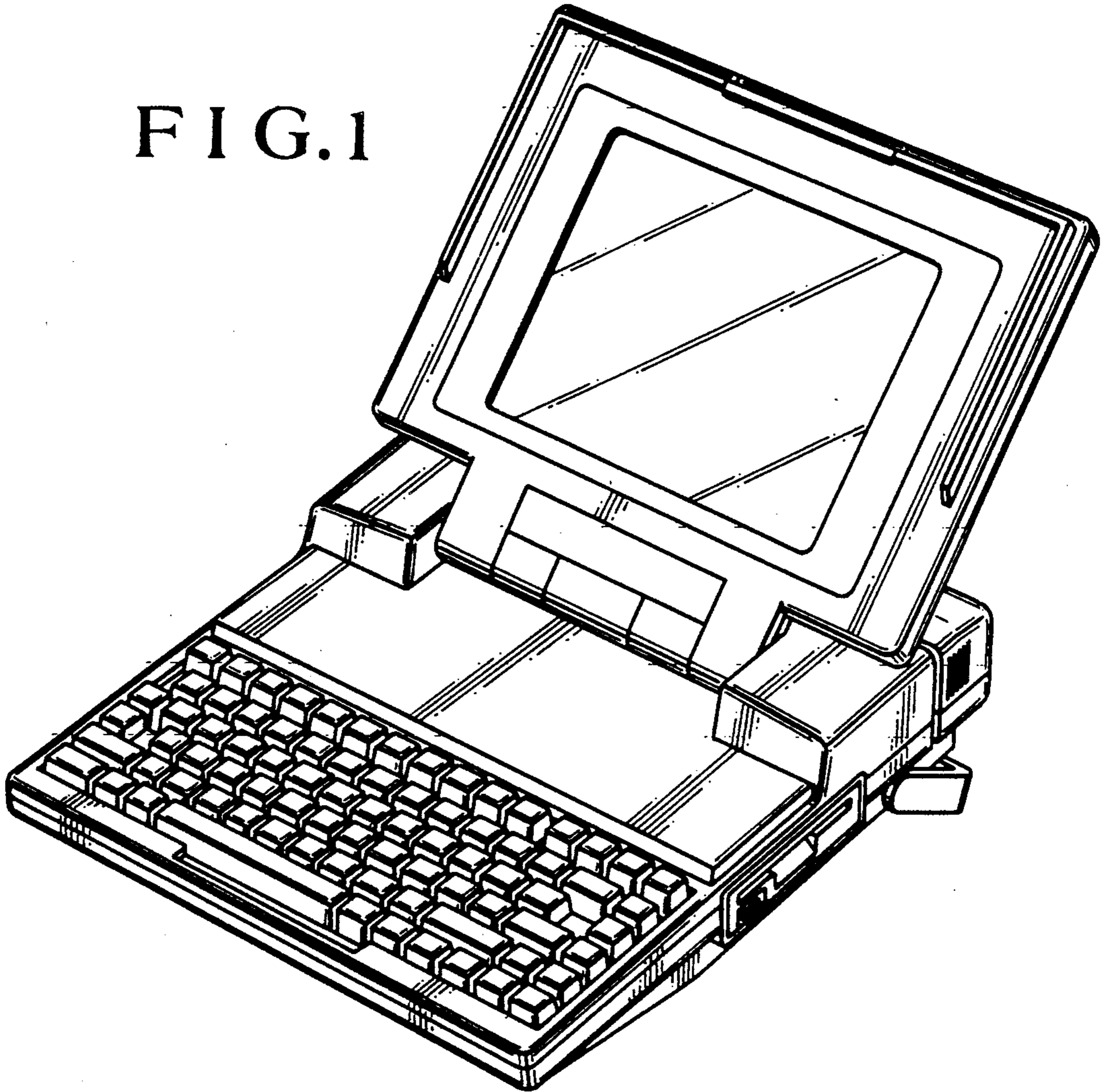

FIG. 2

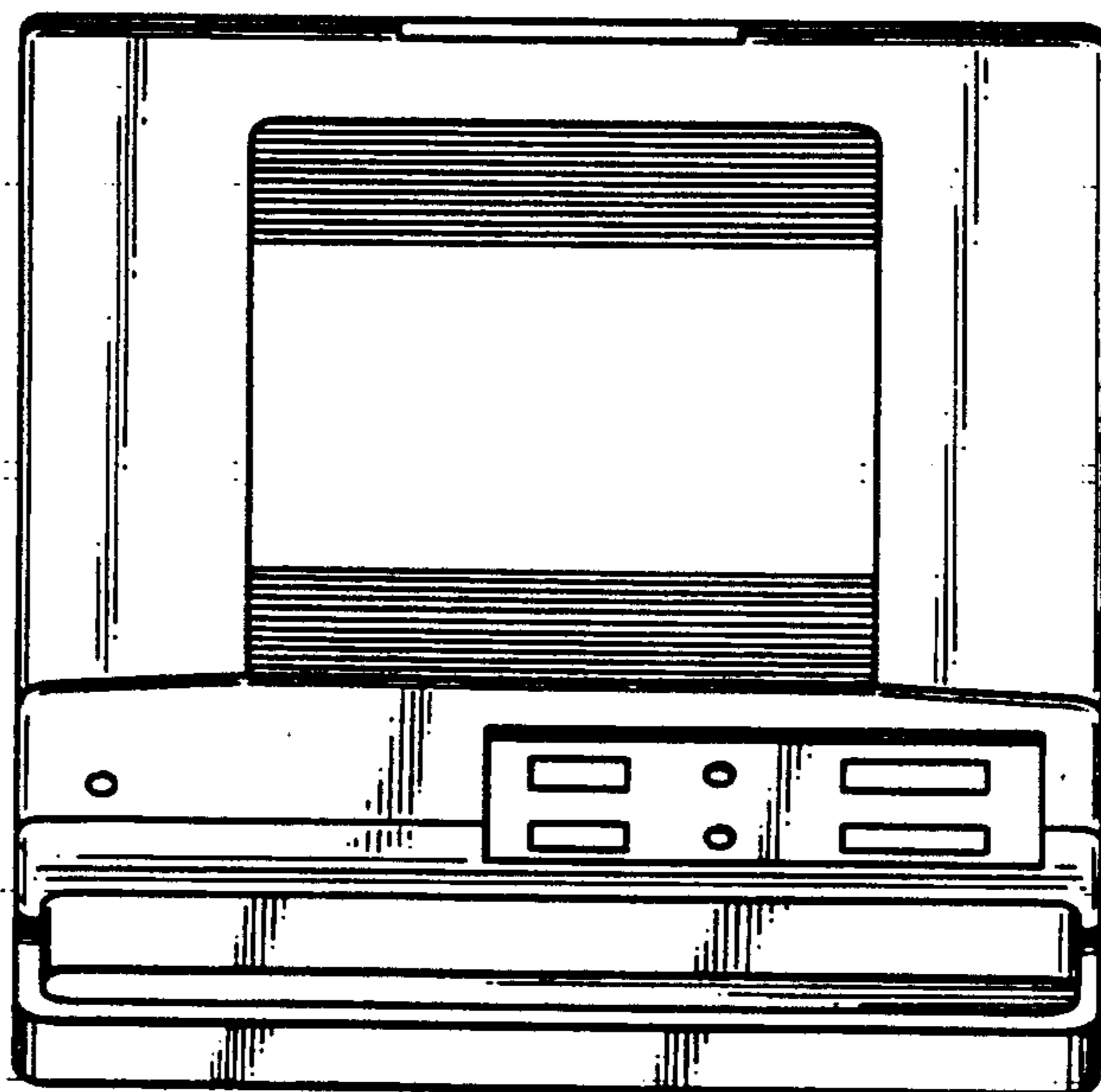

FIG.3

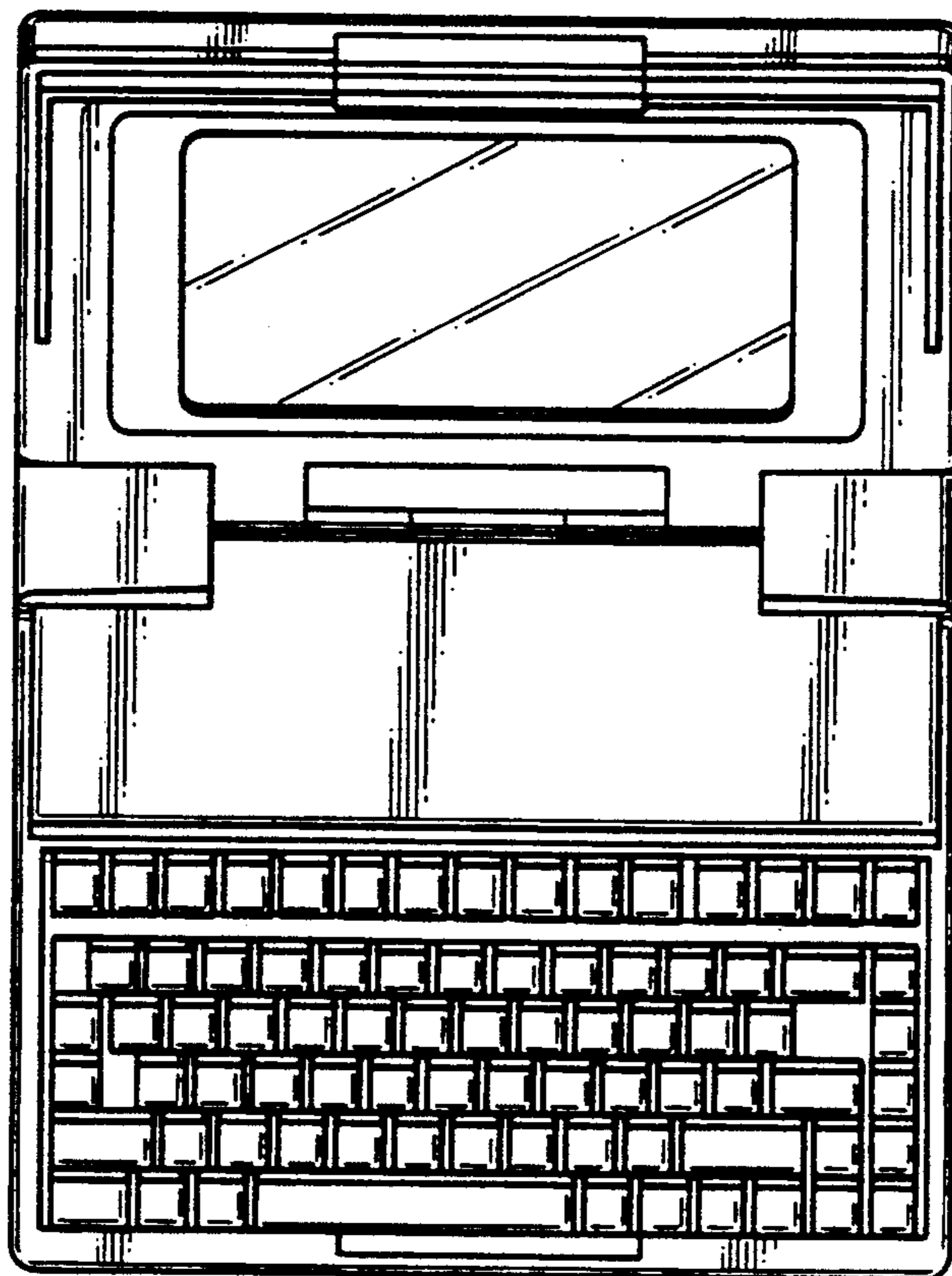

FIG.4

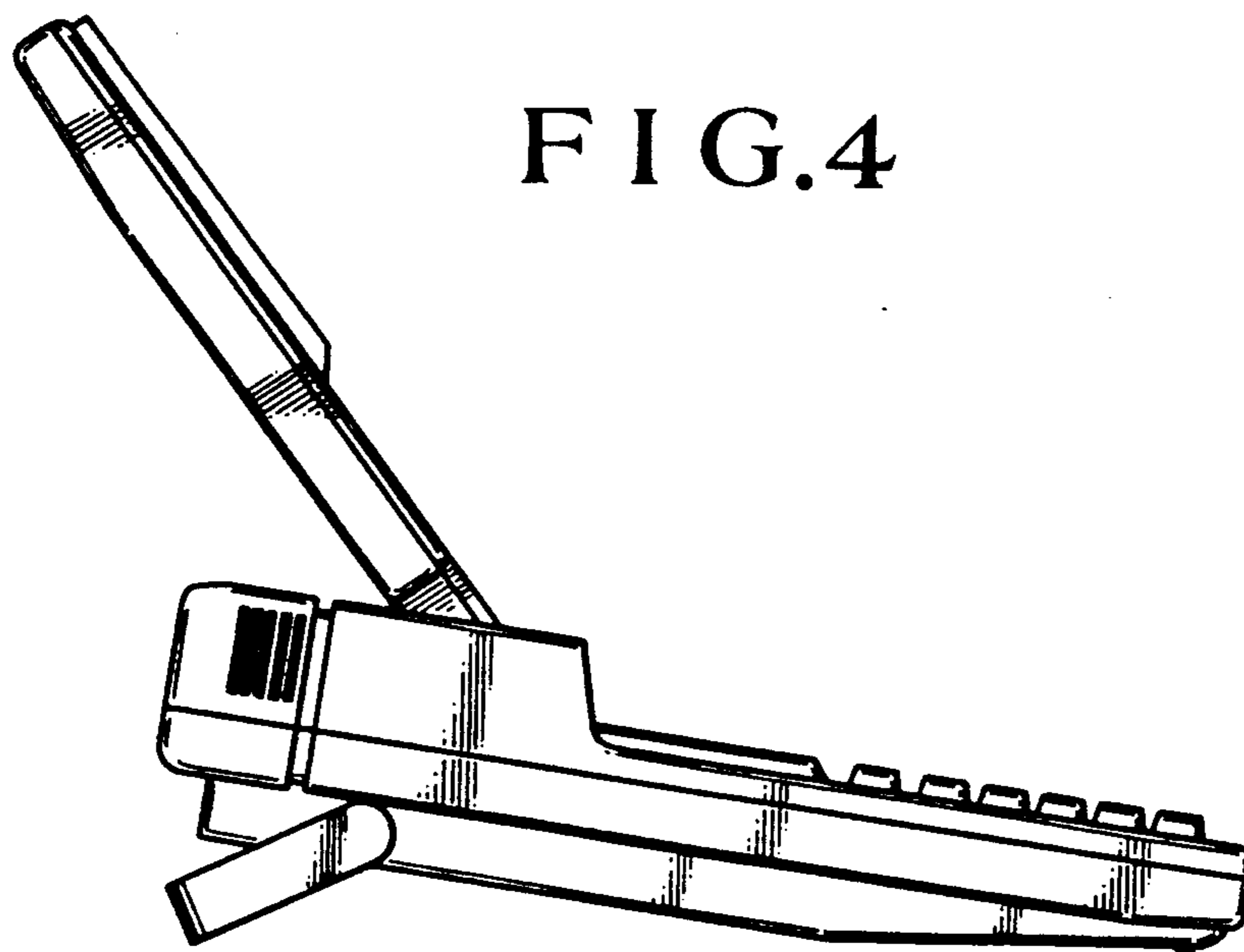

FIG. 5

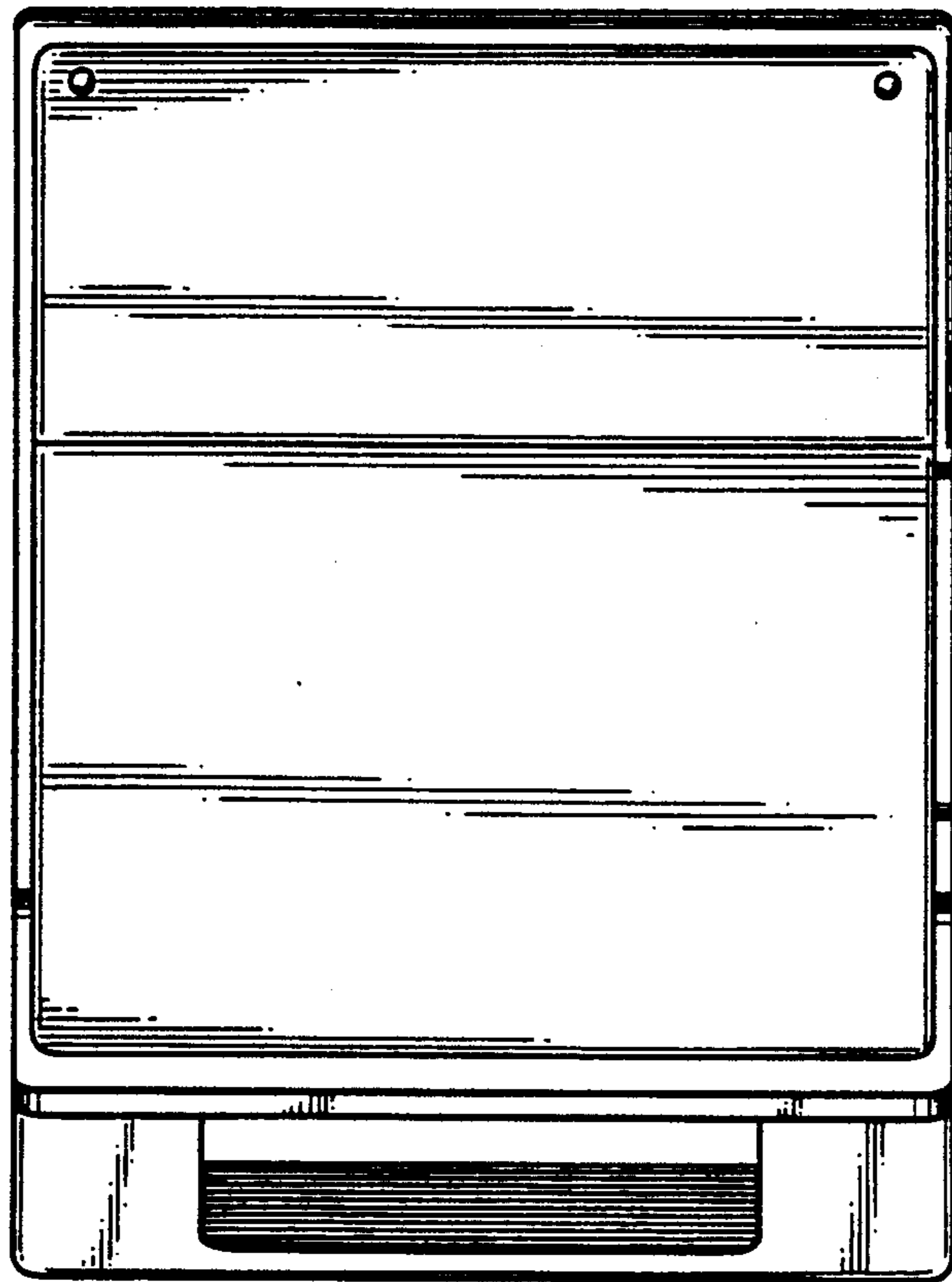

FIG. 6

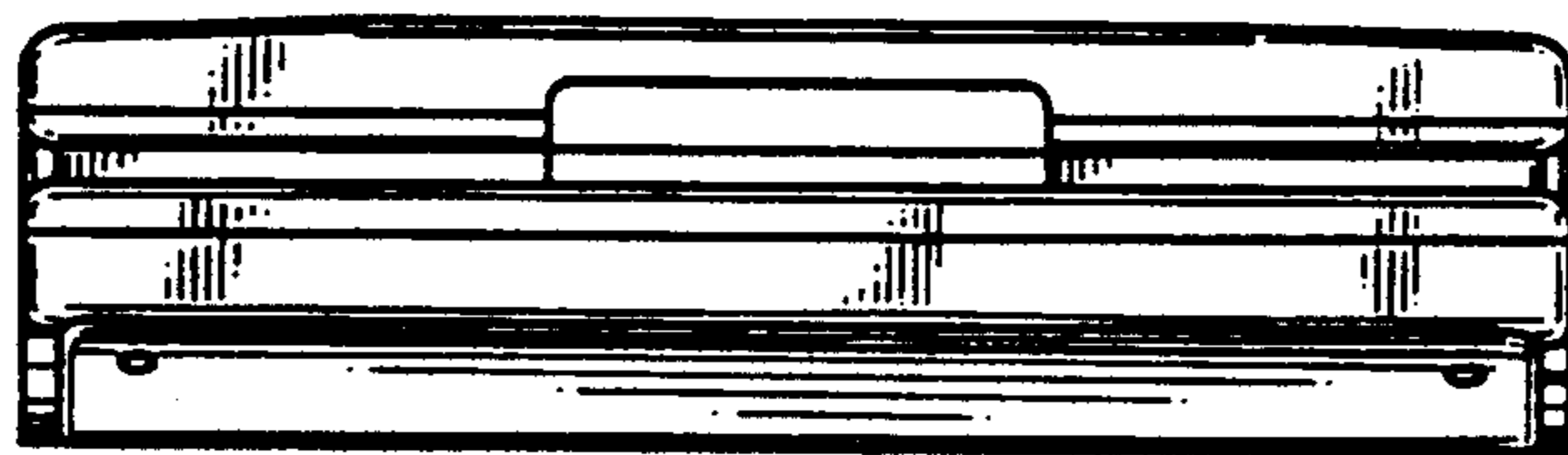

FIG. 7

