

[54] FLATIRON

4,702,933 10/1987 Kramer 219/245 X

[75] Inventor: Ludwig Littmann, Königstein, Fed. Rep. of Germany

[73] Assignee: Braun AG, Kronberg, Fed. Rep. of Germany

[**] Term: 14 Years

[21] Appl. No.: 452,947

[22] Filed: Dec. 19, 1989

[30] Foreign Application Priority Data

Jun. 26, 1989 [DE] Fed. Rep. of Germany M8904487.8

[52] U.S. Cl. D32/70

[58] Field of Search D32/68-73; 38/69-71, 74-75, 77.1-77.9, 79, 81-82, 85, 88, 90; 219/245-259, 271-273

[56] References Cited

U.S. PATENT DOCUMENTS

- D. 284,800 7/1986 Cavalli D32/70
- D. 291,130 7/1987 Brun D32/70
- D. 291,615 8/1987 Ogawa D32/70

FOREIGN PATENT DOCUMENTS

- MR10588 3/1985 Fed. Rep. of Germany .
- 73MR9391 4/1985 Fed. Rep. of Germany .
- 73MR9441 12/1985 Fed. Rep. of Germany .
- MR10728 11/1986 Fed. Rep. of Germany .

Primary Examiner—Wallace R. Burke
Assistant Examiner—Lavone D. Tabor
Attorney, Agent, or Firm—Fish & Richardson

[57] CLAIM

The ornamental design for a flatiron, as shown and described.

DESCRIPTION

FIG. 1 is a perspective view of a flatiron embodying my new design;
FIG. 2 is a left side elevational view thereof;
FIG. 3 is a right side elevational view thereof;
FIG. 4 is a front elevational view thereof;
FIG. 5 is a rear elevational view thereof;
FIG. 6 is a bottom plan view thereof; and
FIG. 7 is a top plan view thereof.
The conventional cord is partially shown in all views for ease of illustration.

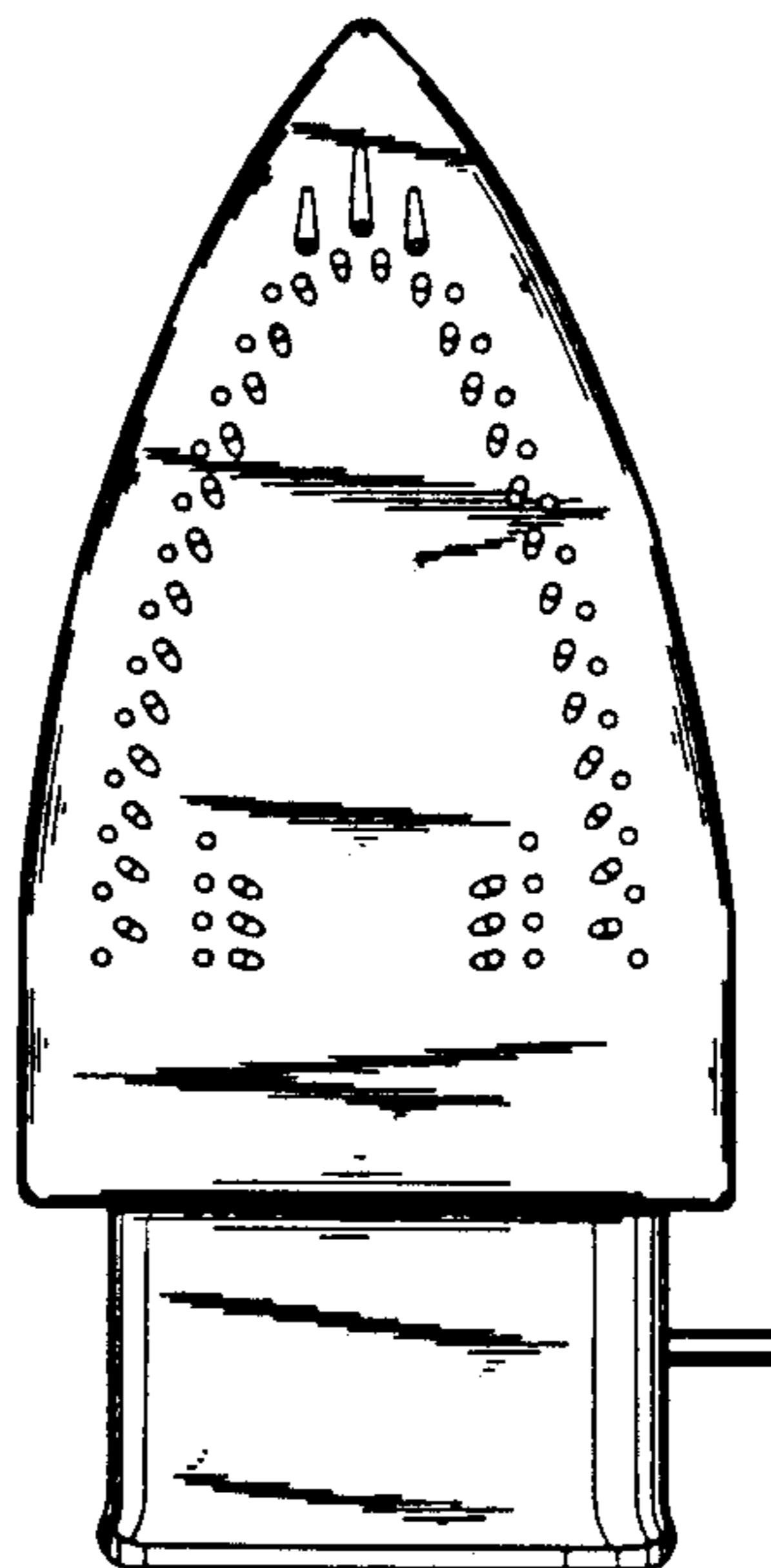
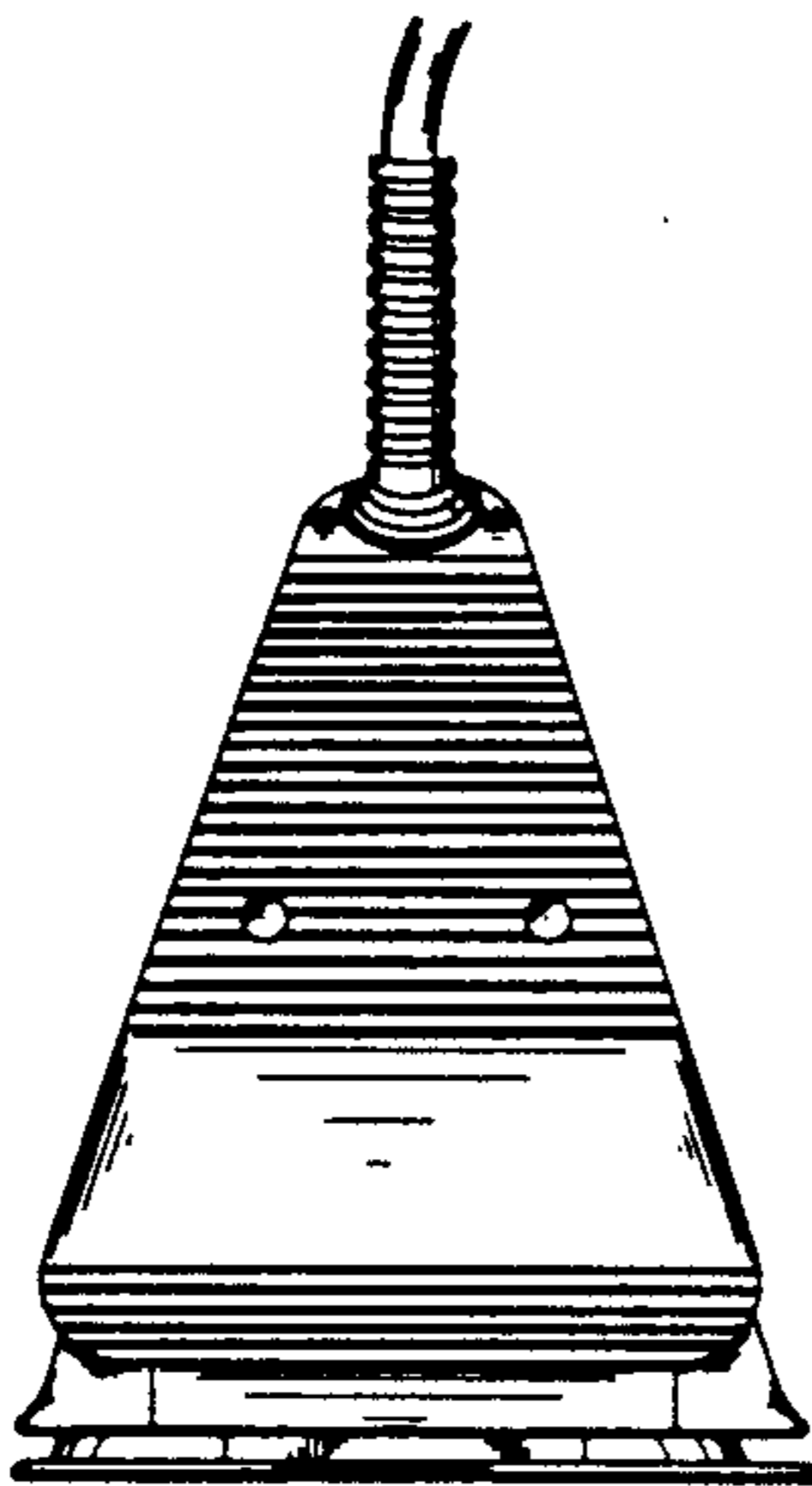
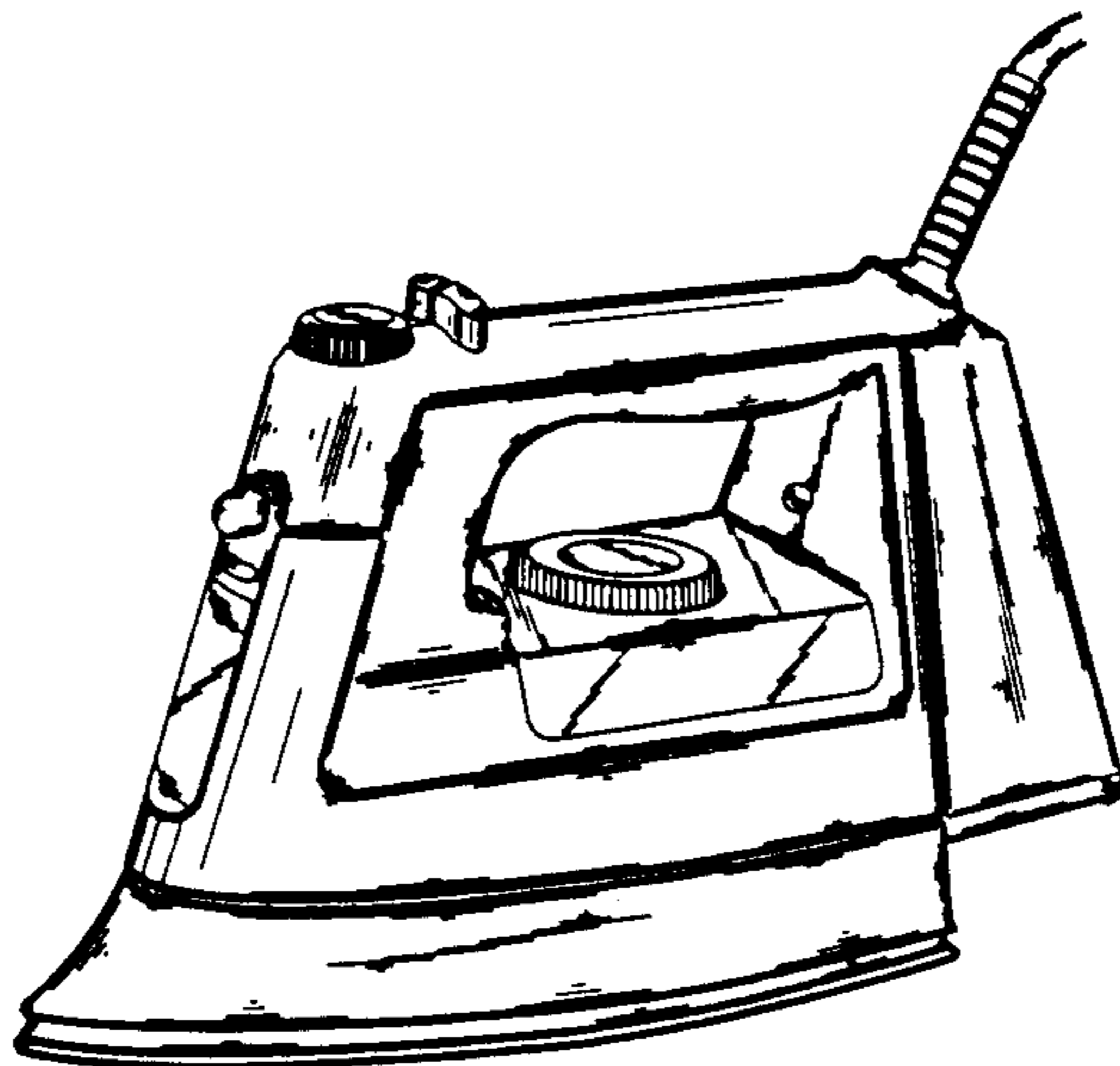

FIG. 1

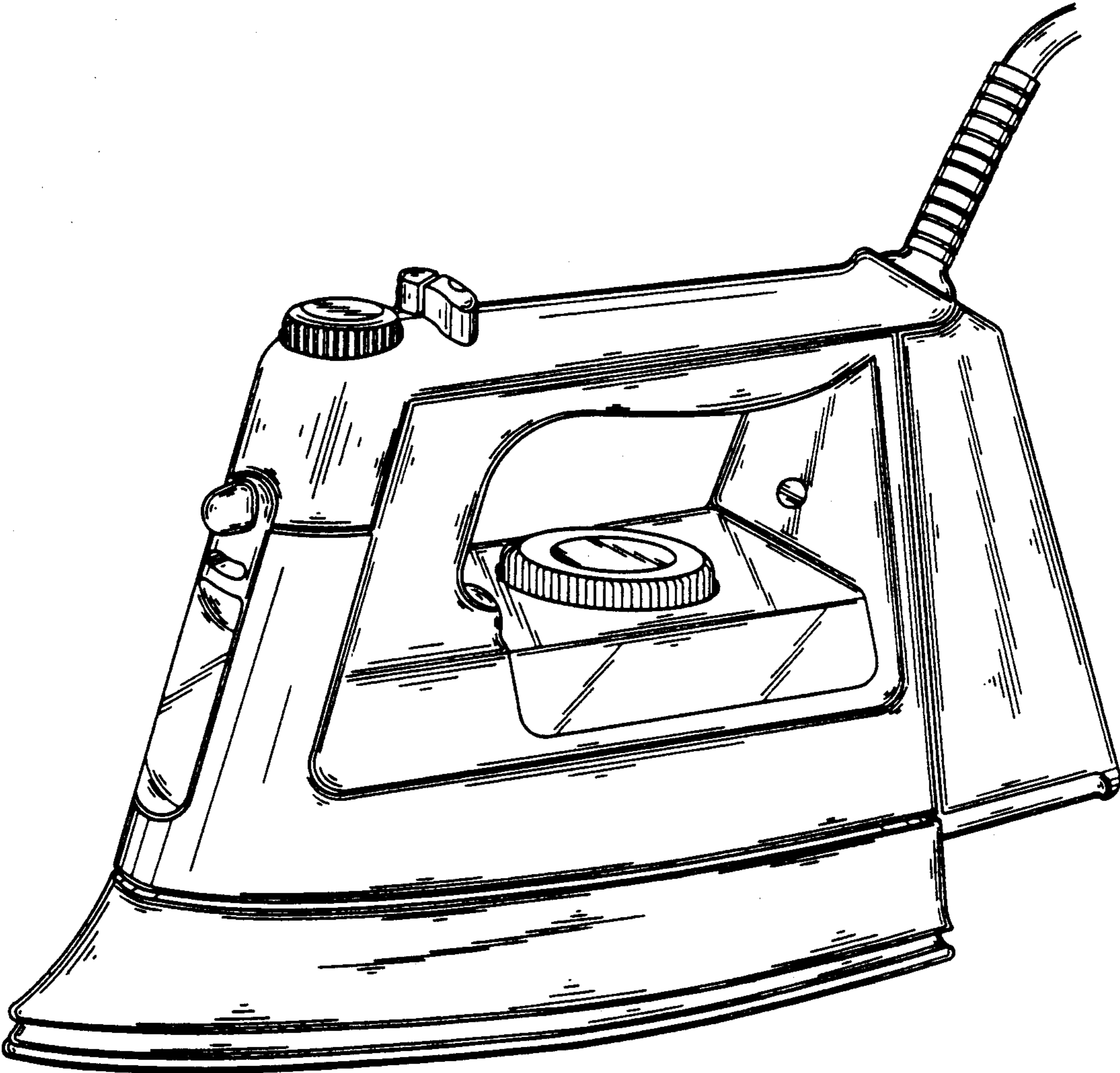

FIG. 2

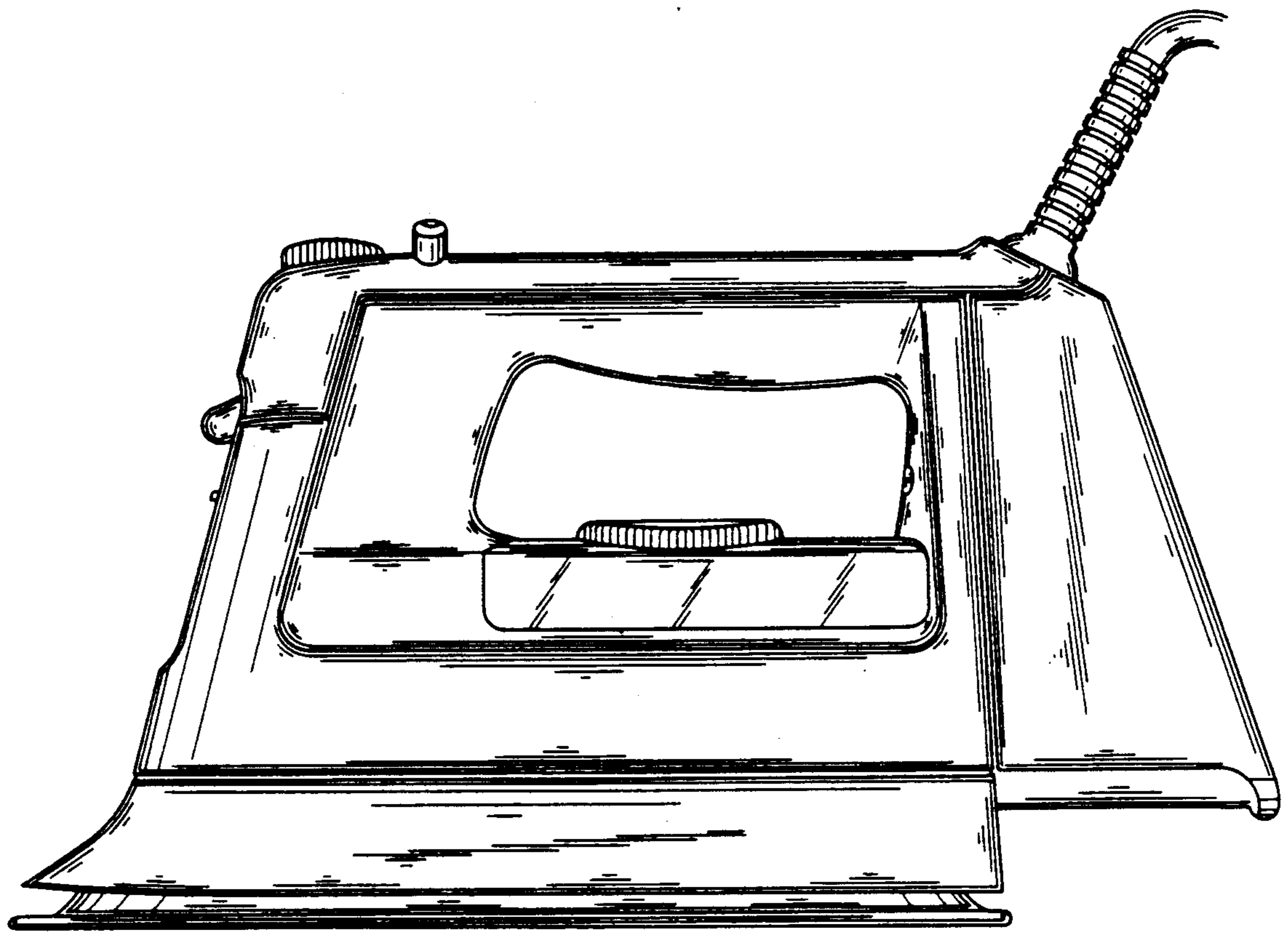
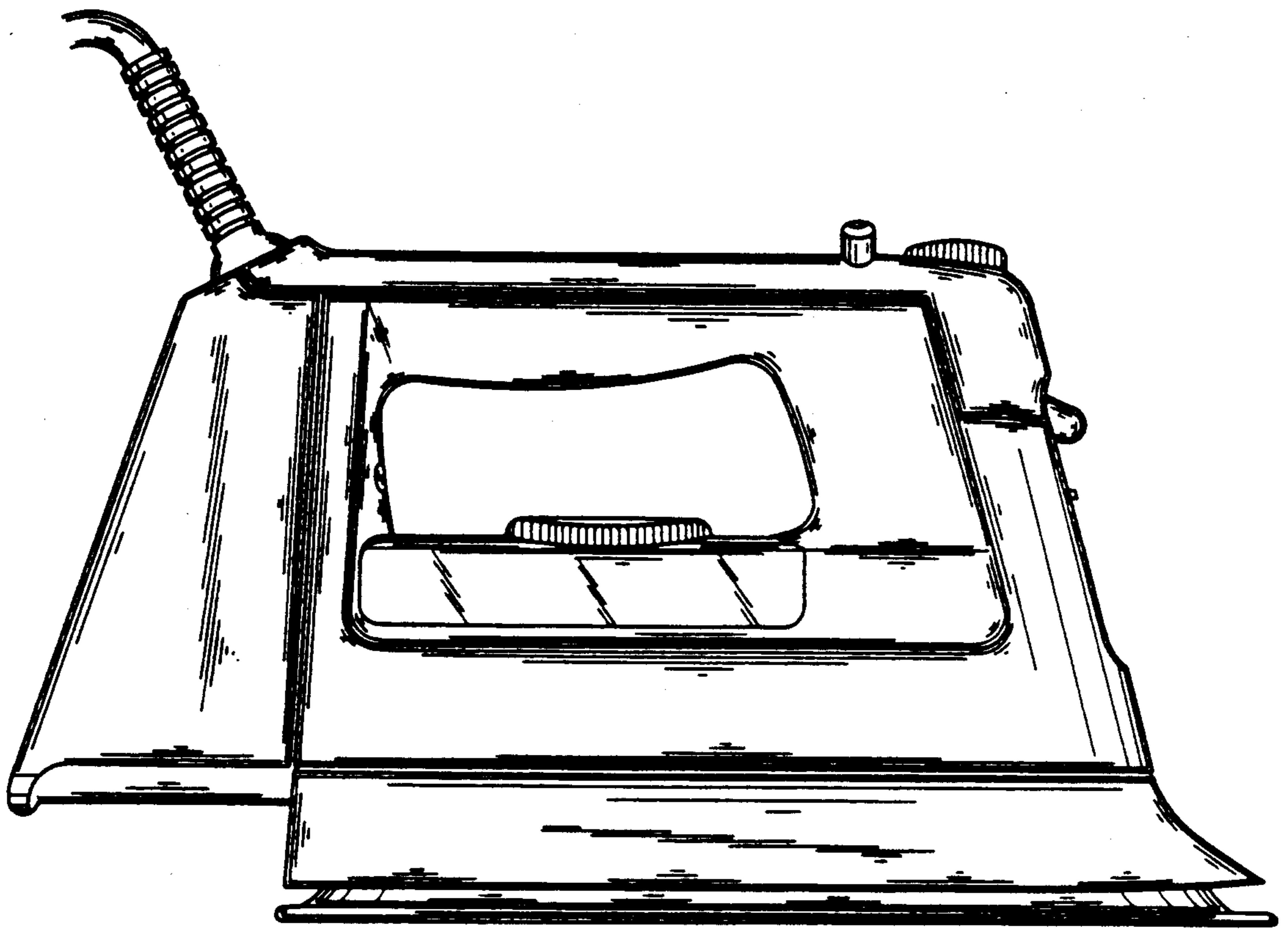

FIG. 3



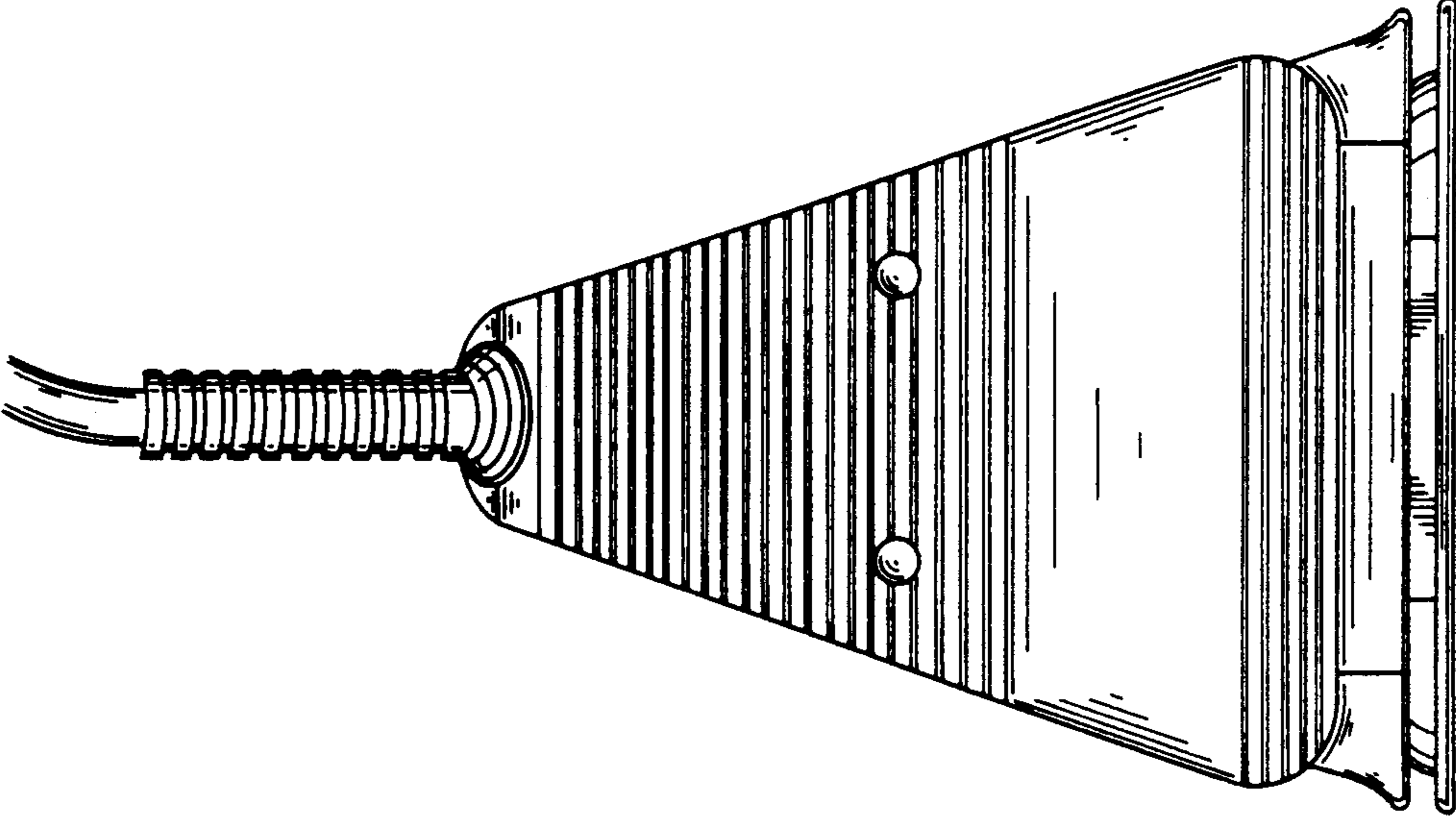

FIG. 5

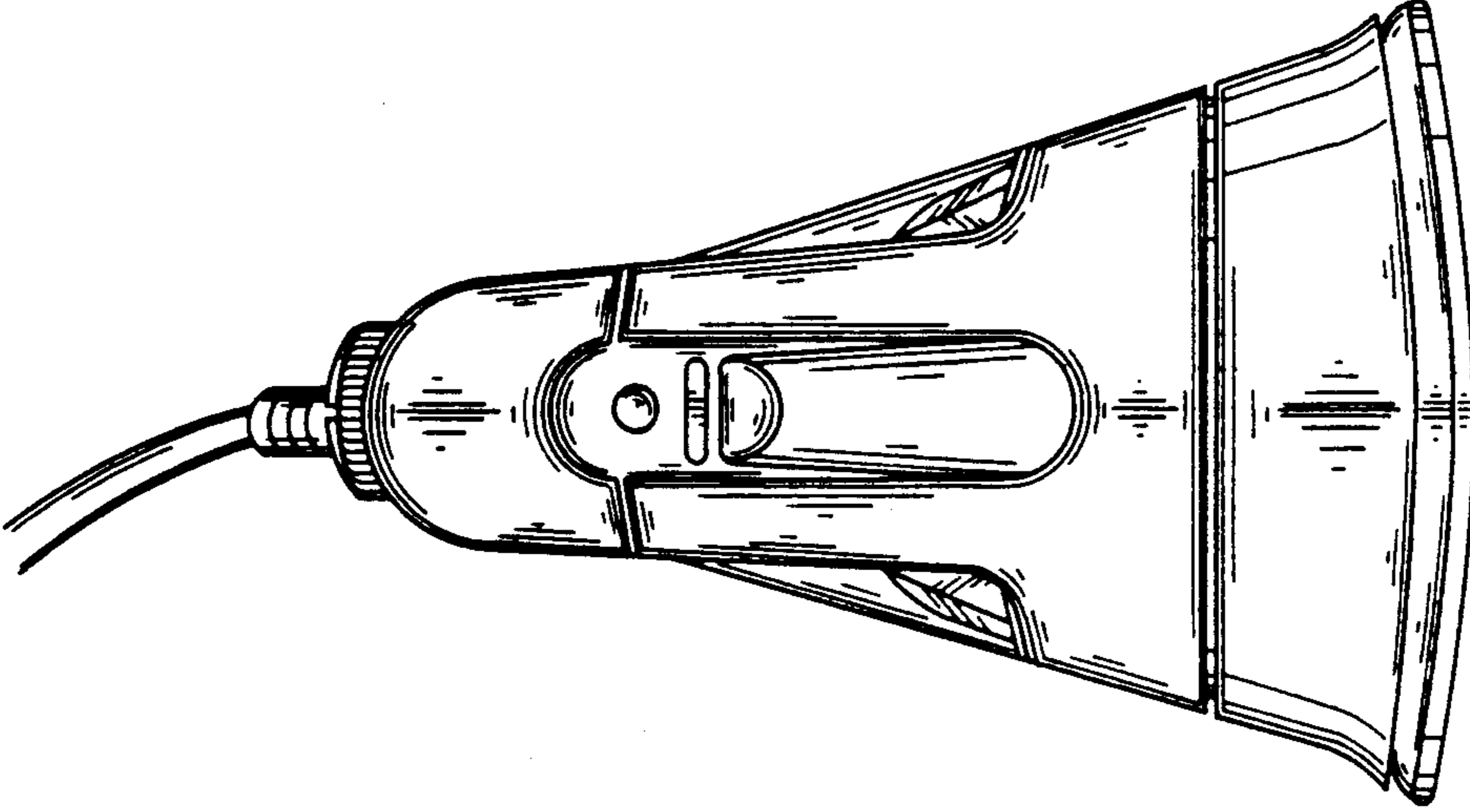

FIG. 4

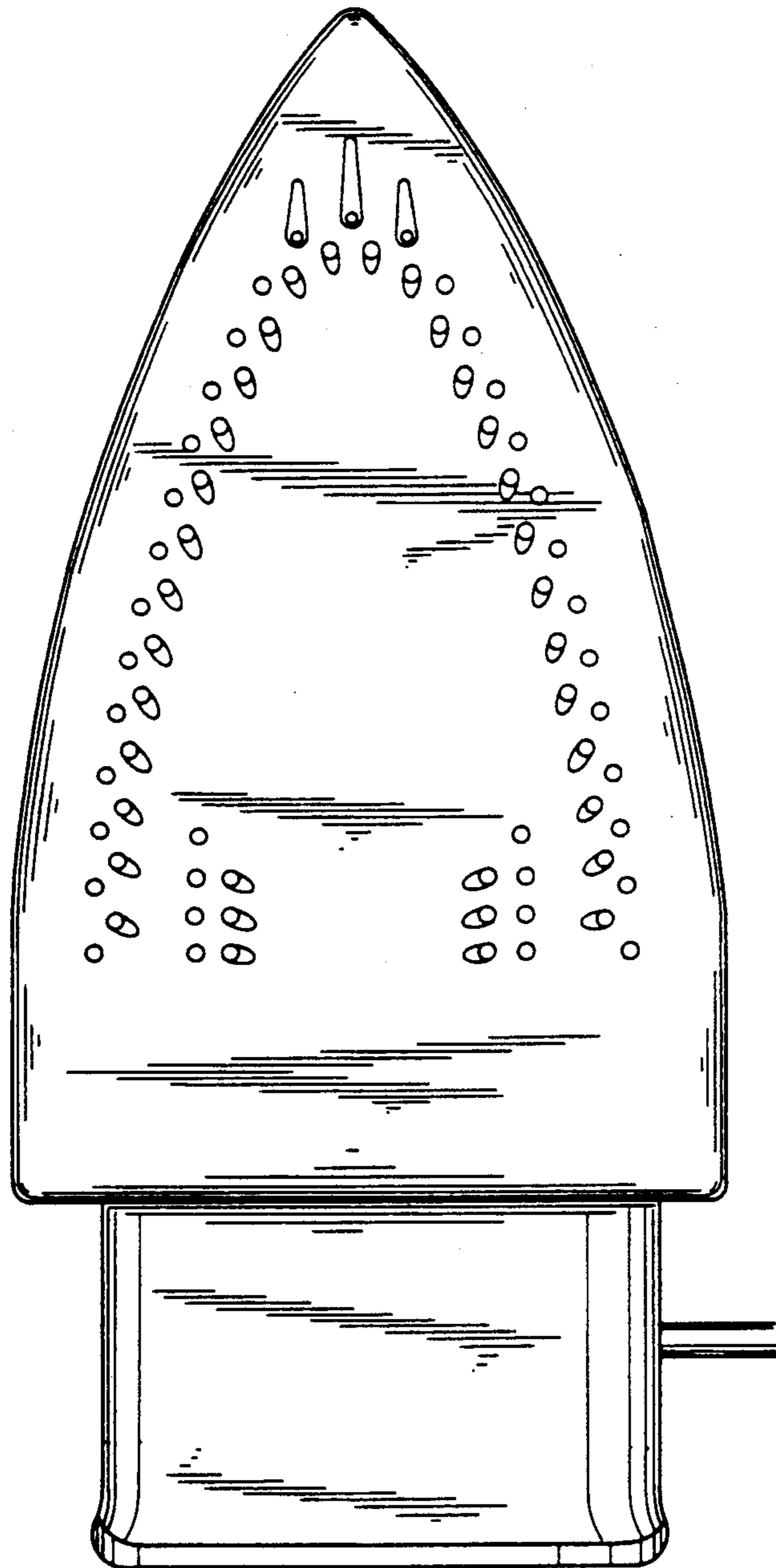

FIG. 6

FIG. 7

