

[54] SUN TANNING BOOTH OR SIMILAR ARTICLE

[76] Inventor: Joseph M. Collier, 1365 Stuart St., Green Bay, Wis. 54301

[**] Term: 14 Years

[21] Appl. No.: 190,232

[22] Filed: May 4, 1988

[52] U.S. Cl. D24/39

[58] Field of Search D24/38, 39; 128/367, 128/373; D23/315, 202; 4/528, 530

[56] References Cited

U.S. PATENT DOCUMENTS

- D. 272,280 1/1984 McKay D24/38
- D. 275,605 9/1984 Taylor D24/38
- 4,508,120 4/1985 Hammond 128/373 X

Primary Examiner—A. Hugo Word
Assistant Examiner—Stella M. Reid
Attorney, Agent, or Firm—Richard C. Litman

[57] CLAIM

The ornamental design for a sun tanning booth or similar article, as shown and described.

DESCRIPTION

FIG. 1 is a left side elevational view of a sun tanning booth or similar article, showing my new design, the right side elevational view being a mirror image thereof;

FIG. 2 is a front elevational view thereof;

FIG. 3 is a top plan view thereof.

FIG. 4 is a rear elevational view thereof.

FIG. 5 is a left side front perspective view thereof.

FIG. 6 is a right side rear perspective view thereof.

FIG. 7 is a bottom plan view thereof.

FIG. 8 is a top plan view of a second embodiment of FIG. 1.

FIG. 9 is a rear elevational view thereof.

FIG. 10 is a bottom plan view thereof.

FIG. 11 is a front elevational view thereof.

FIG. 12 is a left side elevational view thereof, the right side elevational view being a mirror image thereof.

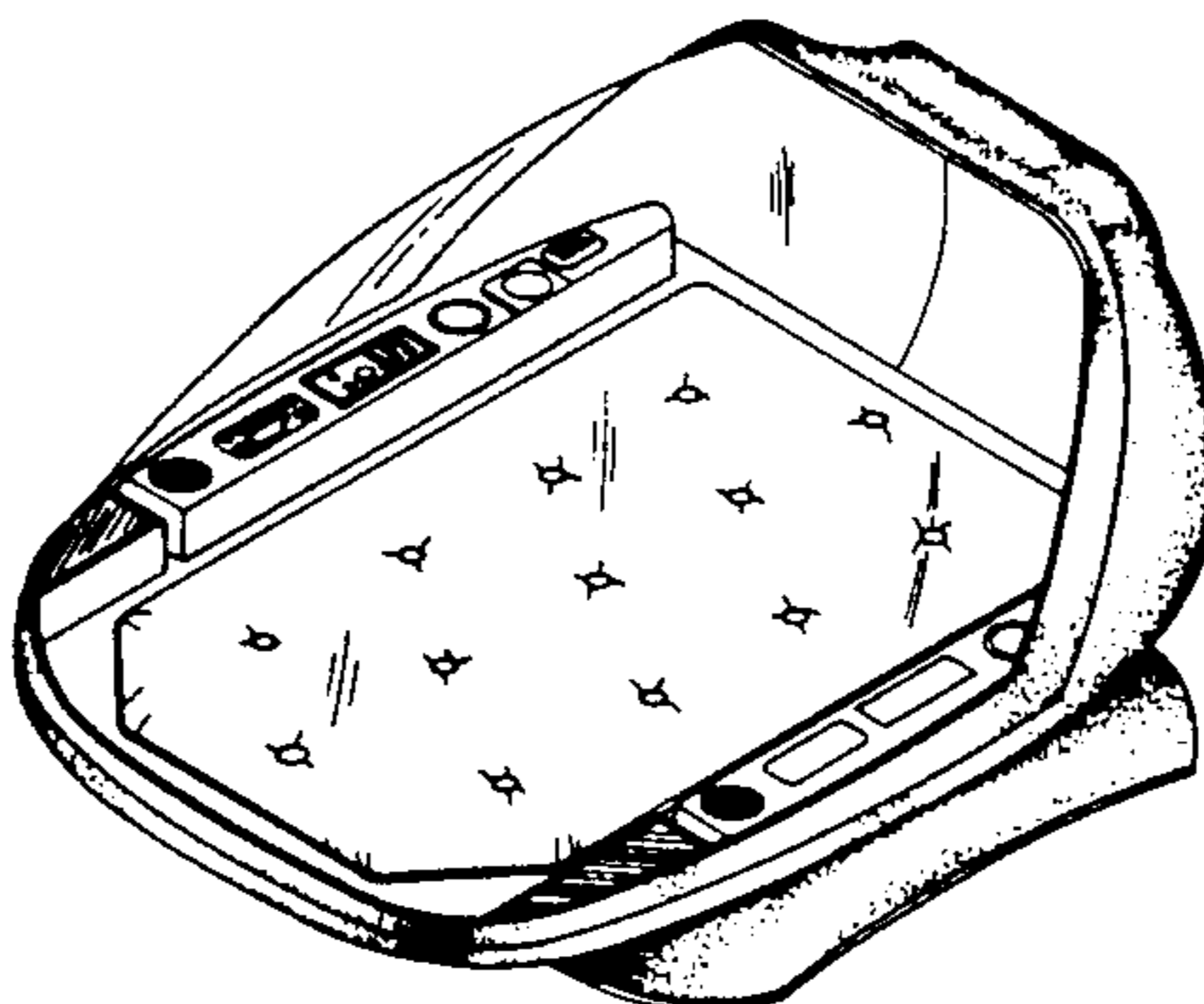
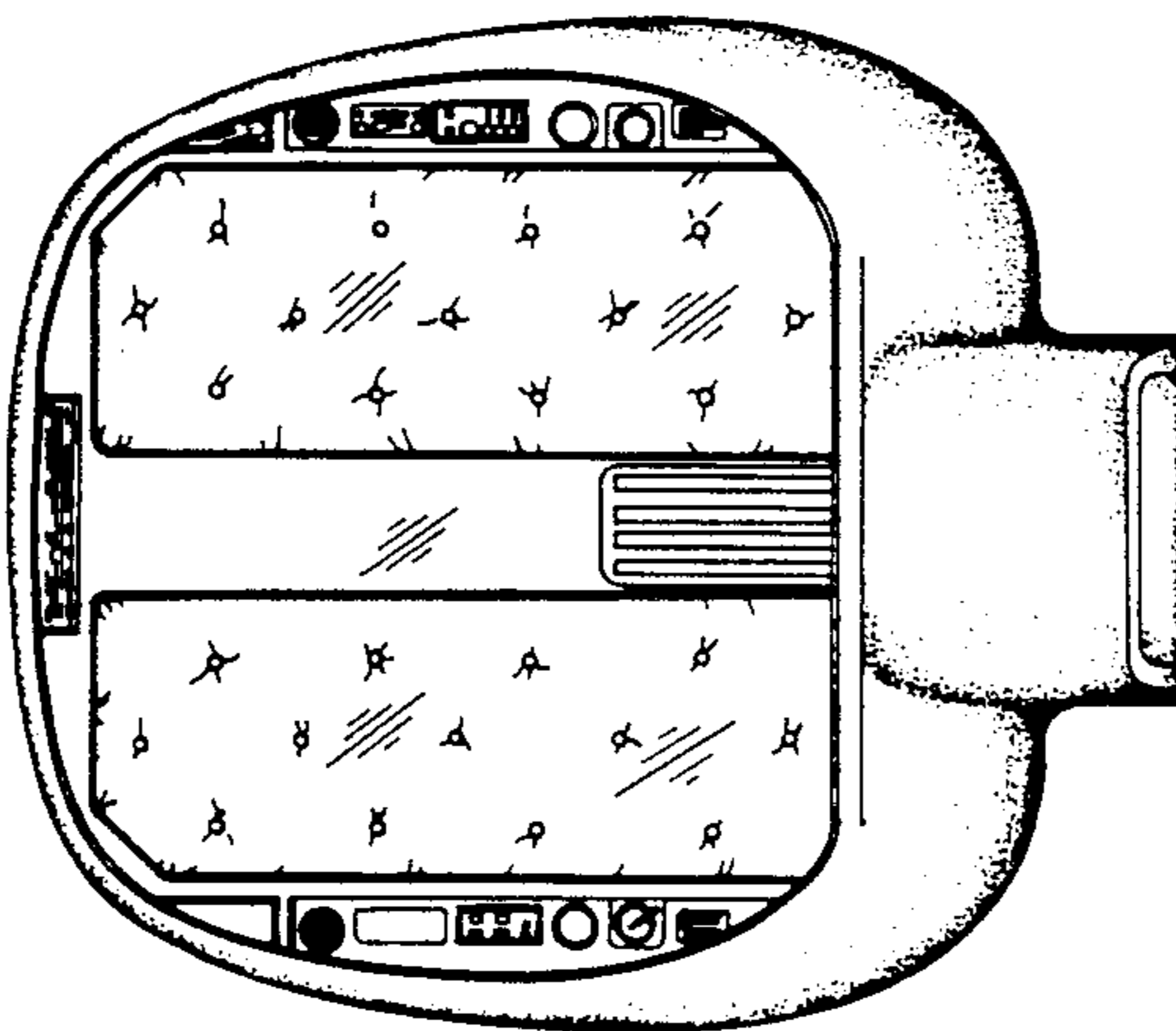
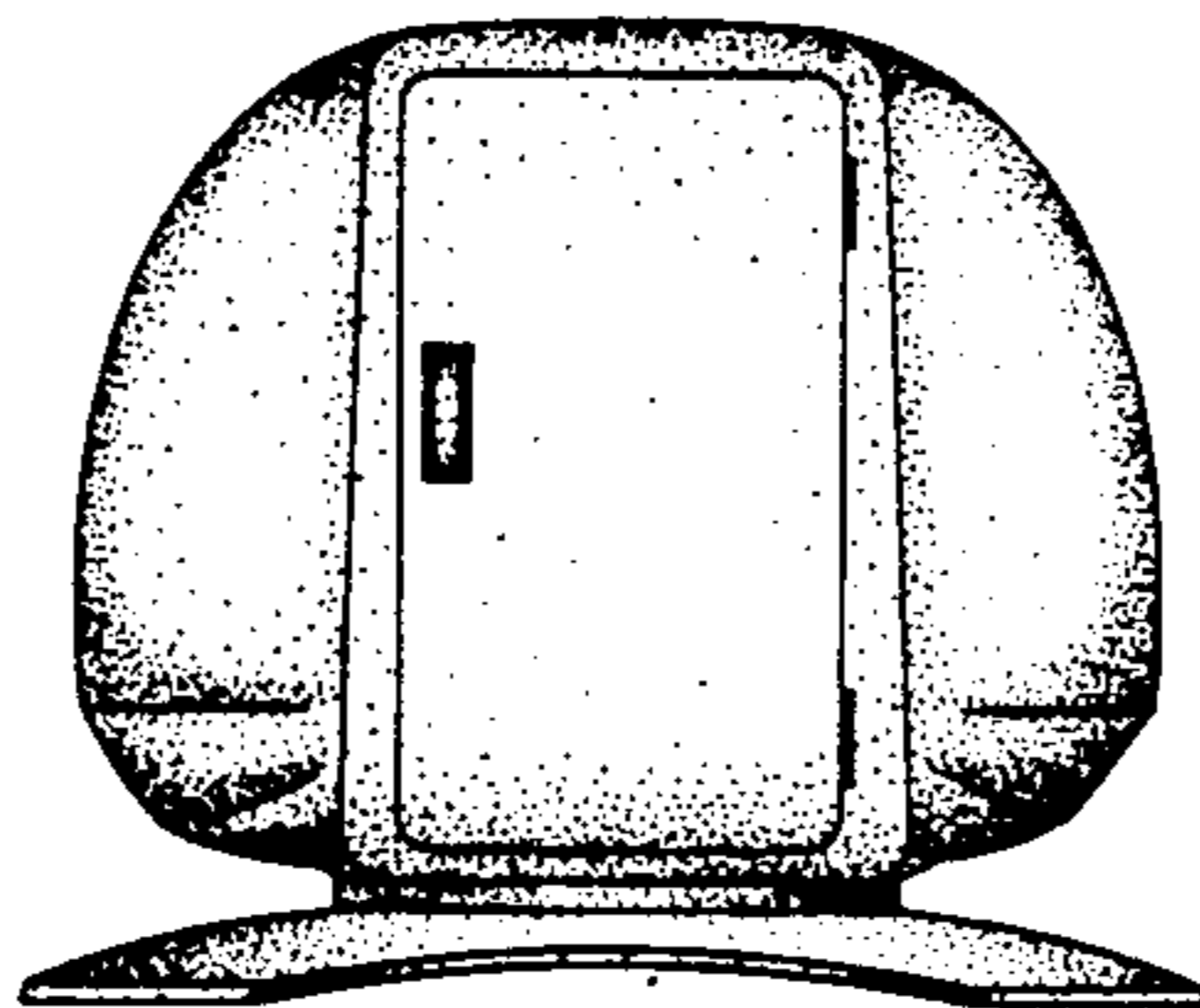

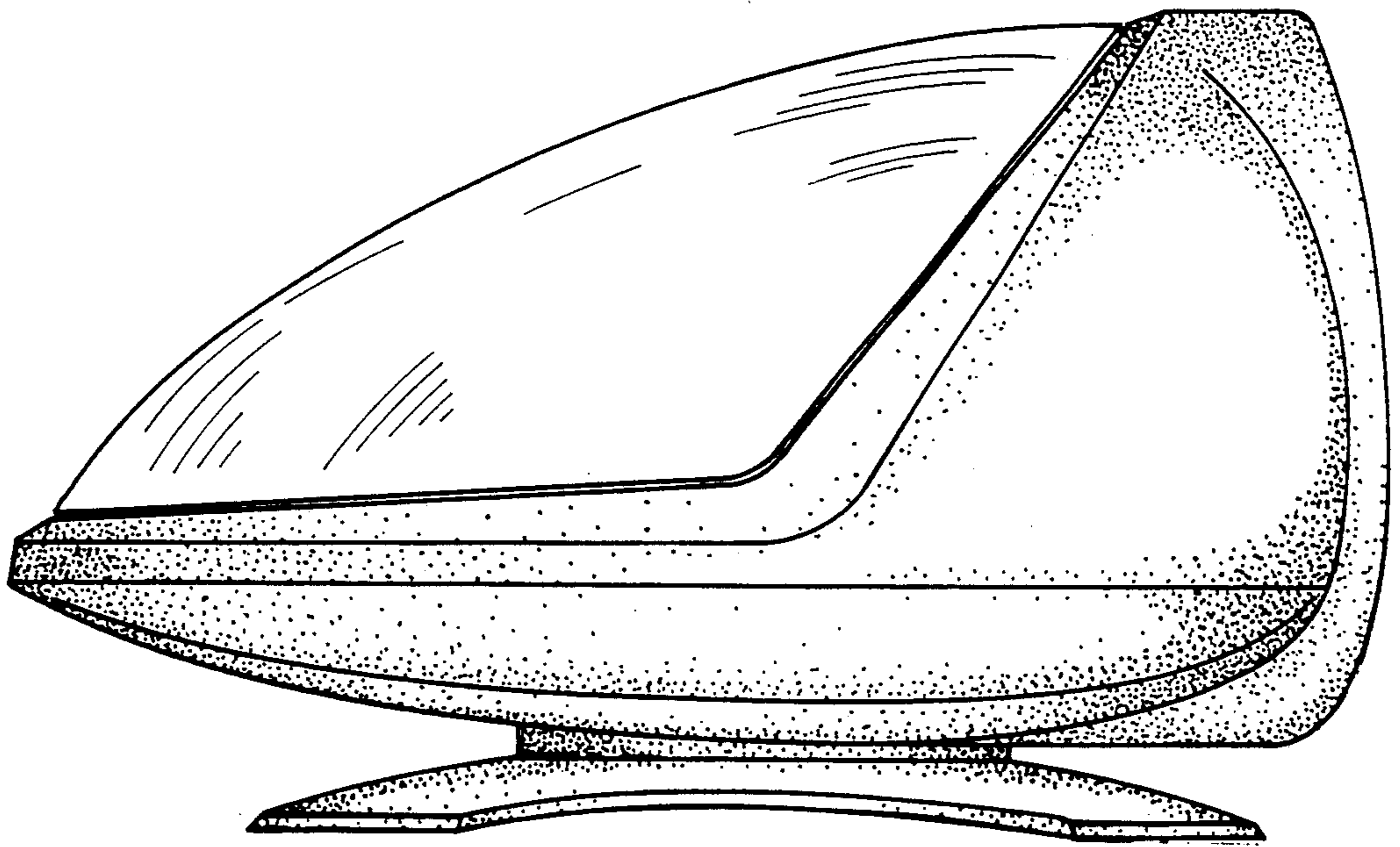

FIG. 1

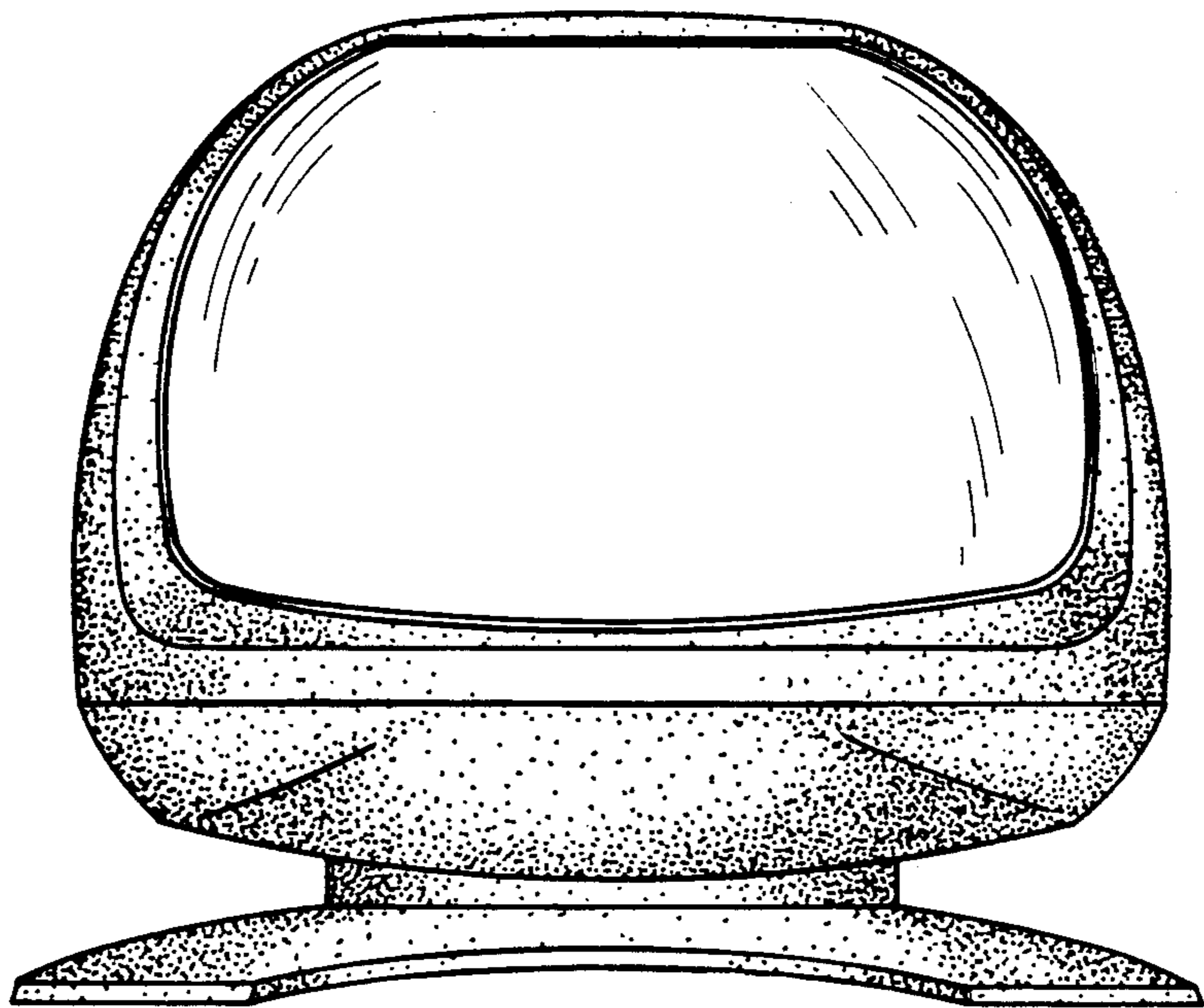

FIG. 2

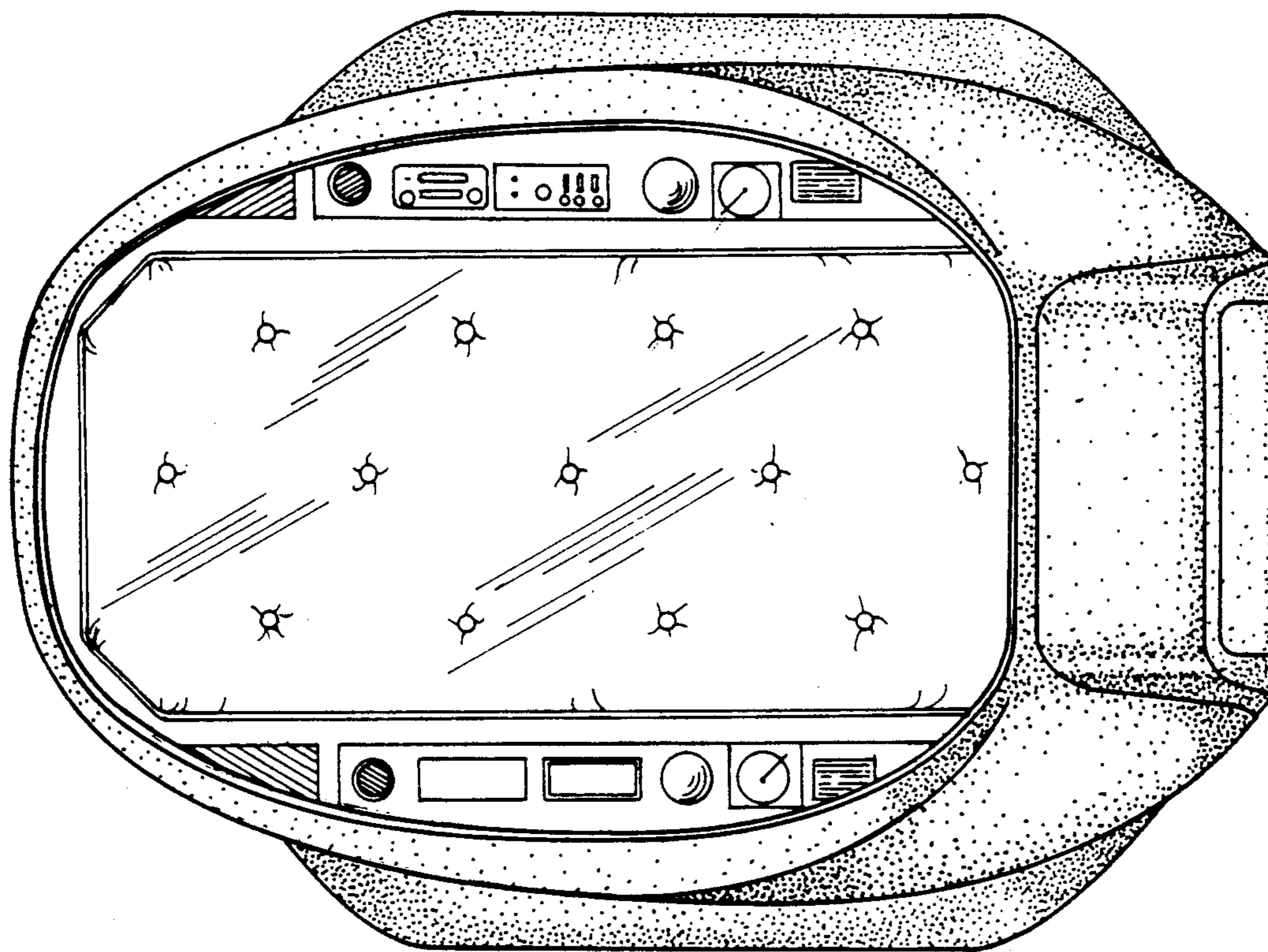

FIG. 3

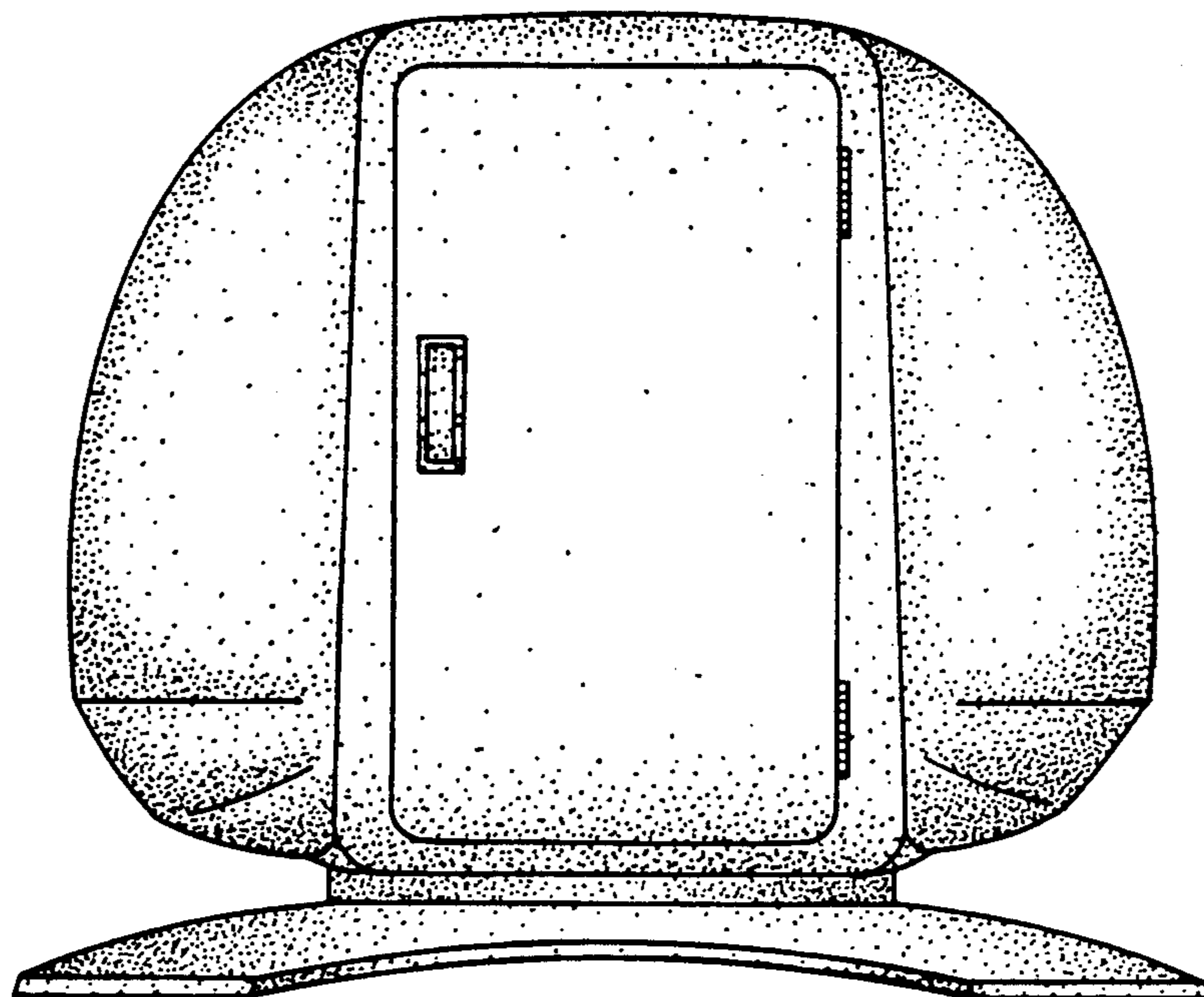

FIG. 4

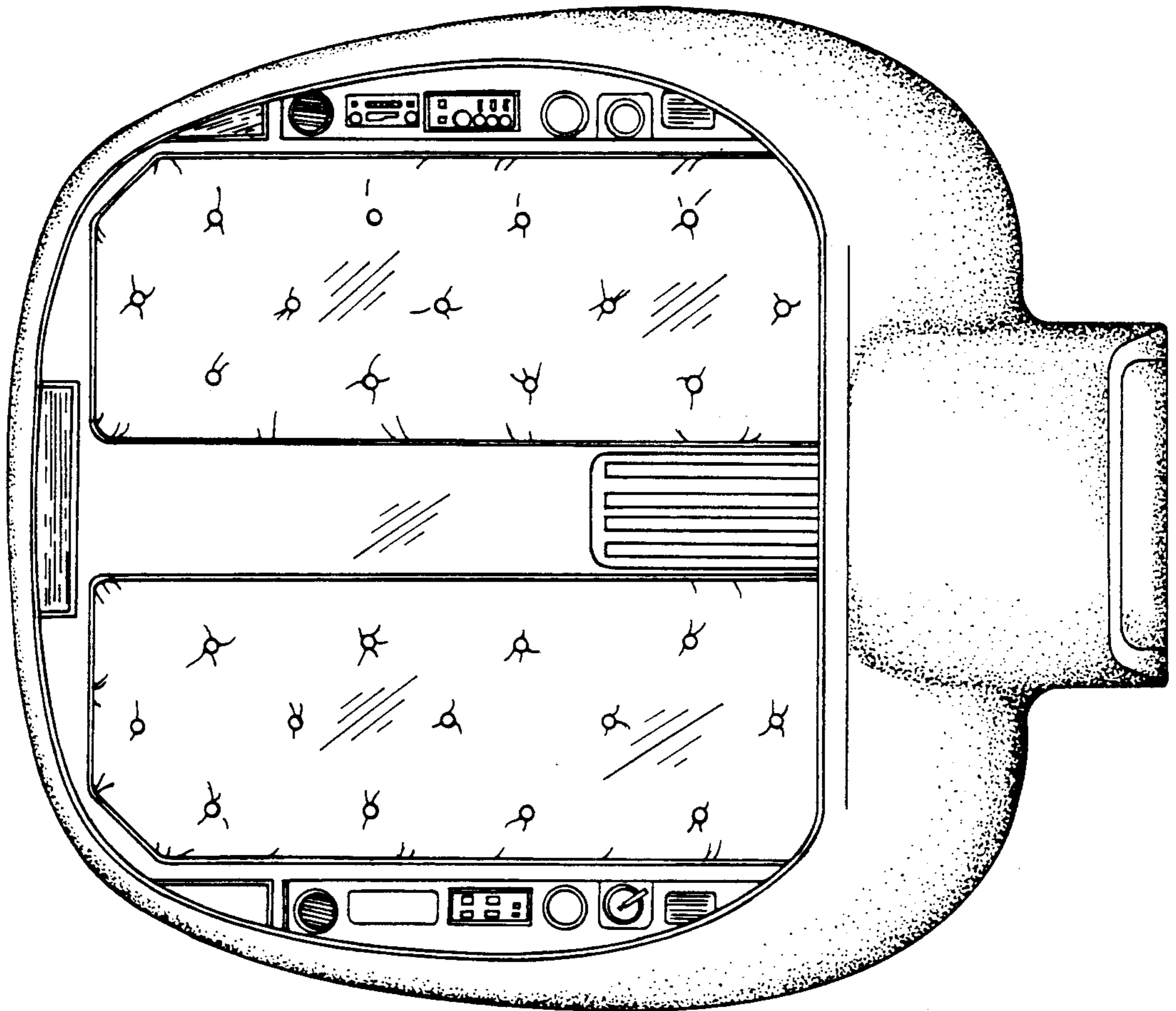

FIG. 8

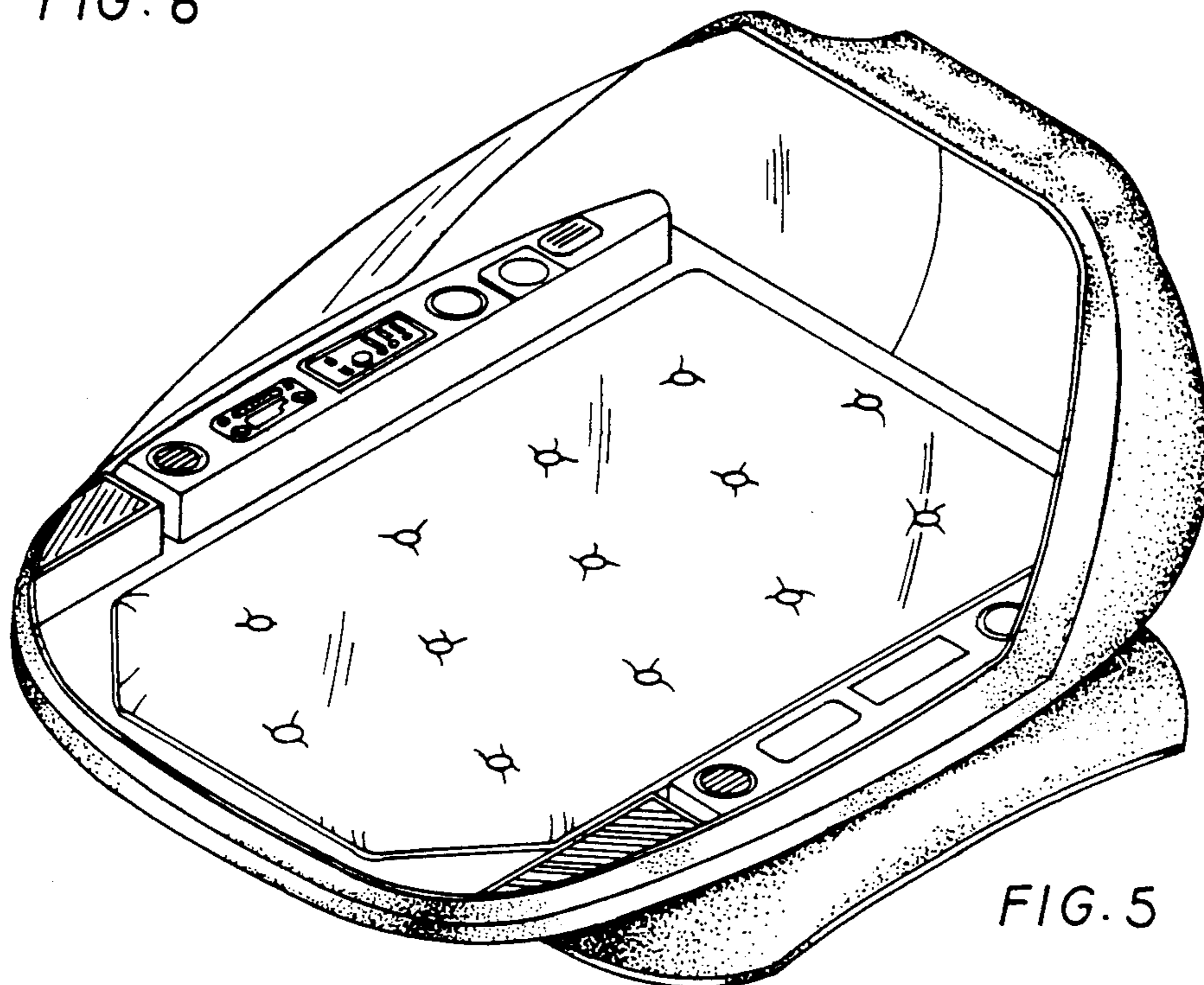

FIG. 5

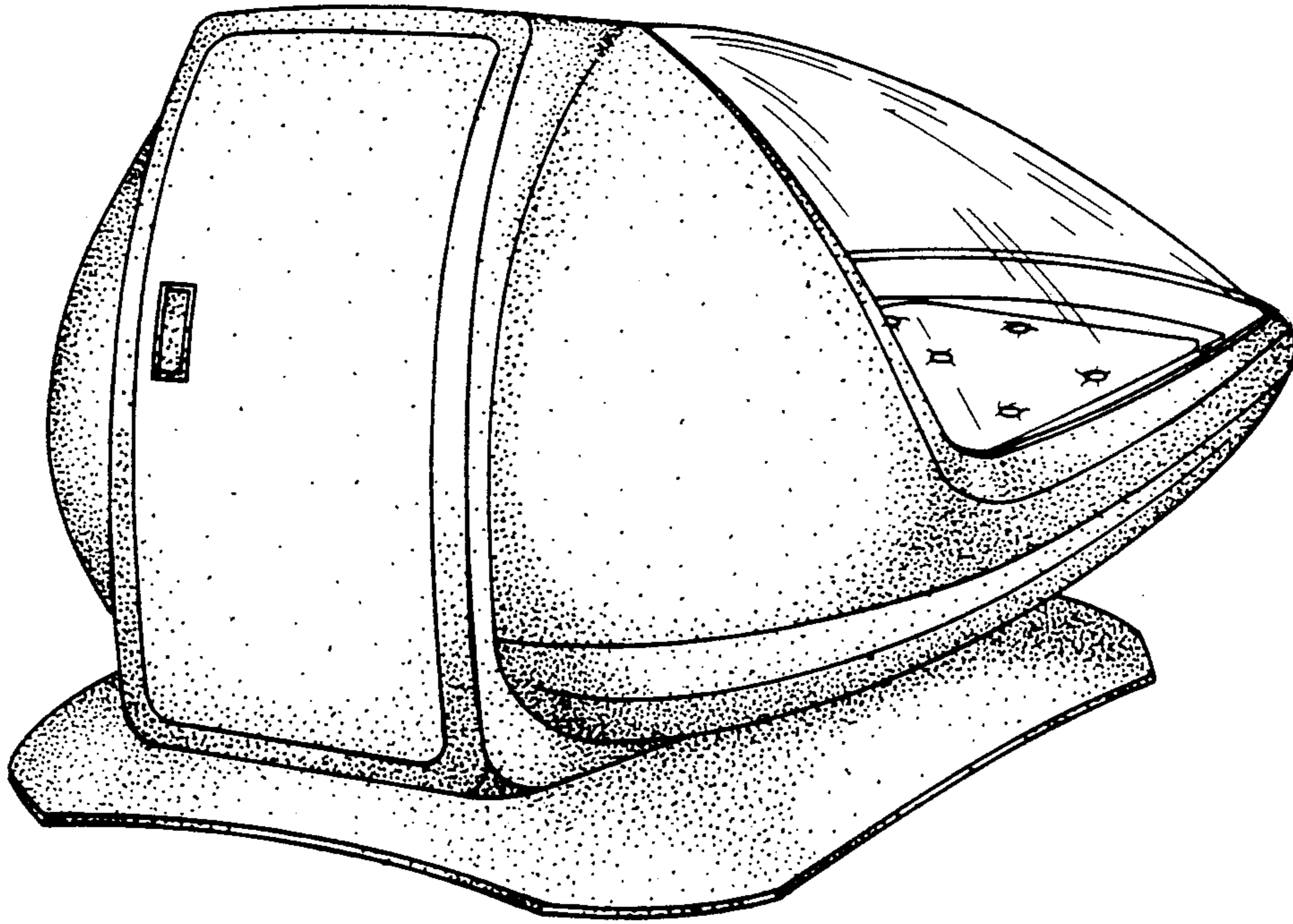

FIG. 6

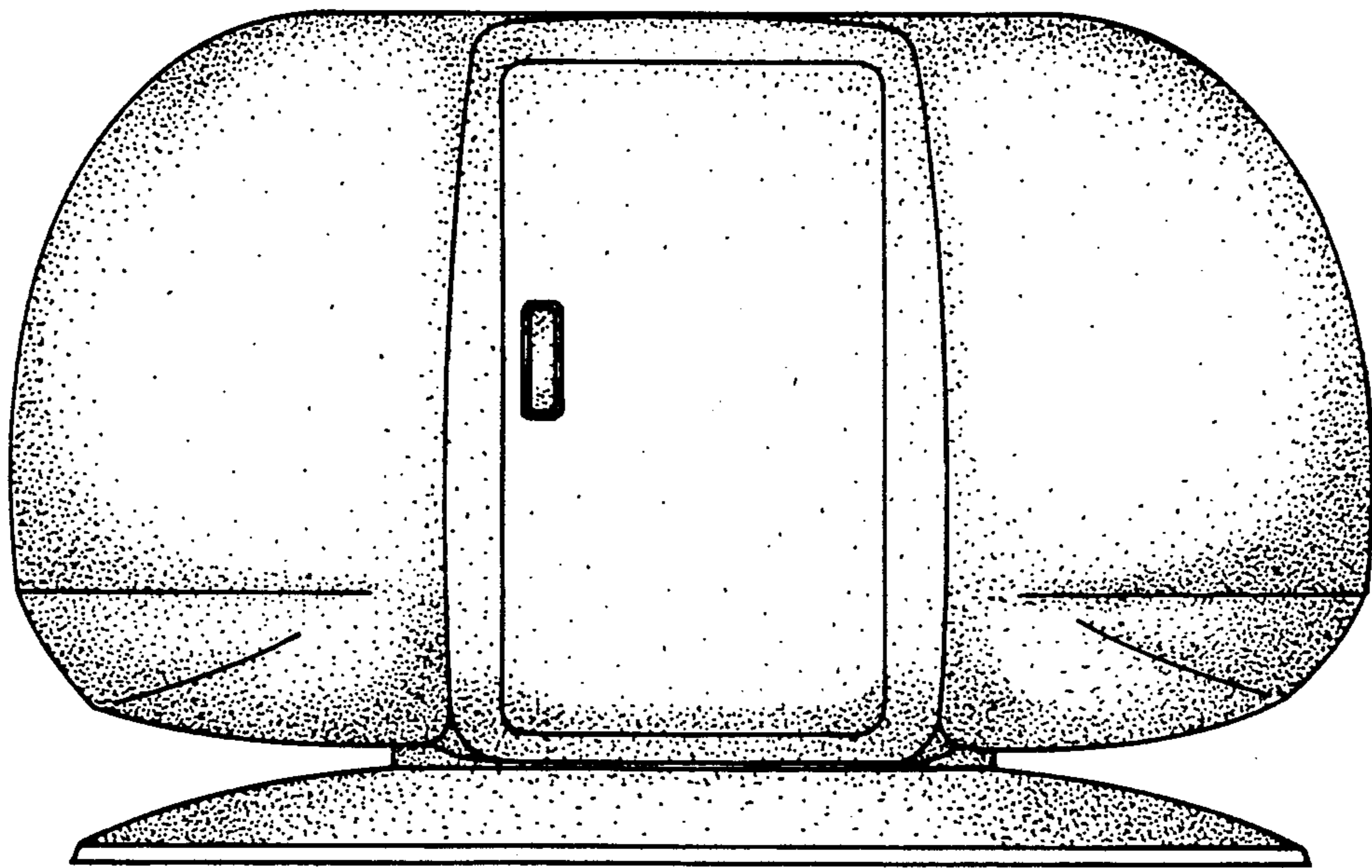

FIG. 9

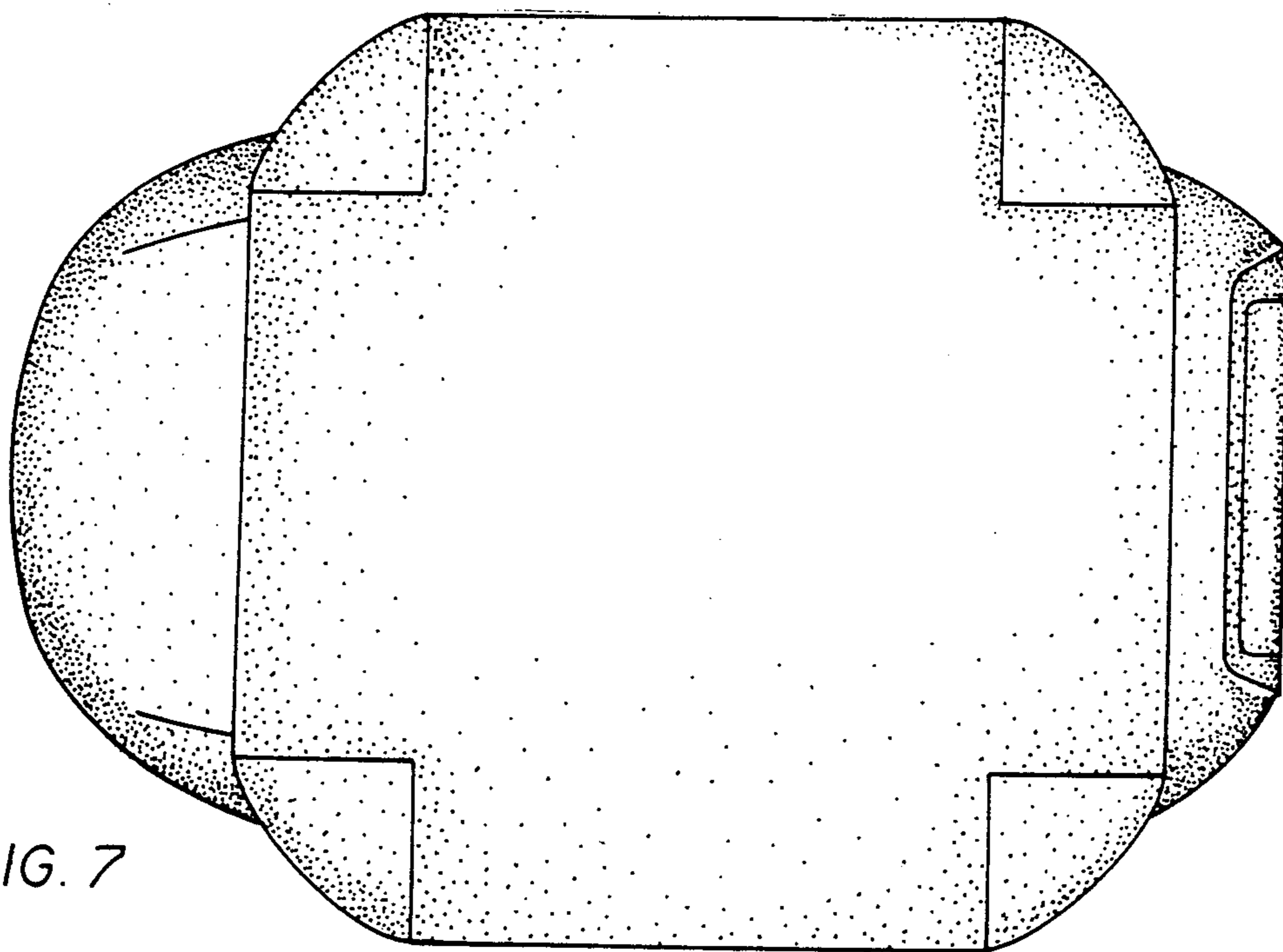

FIG. 7

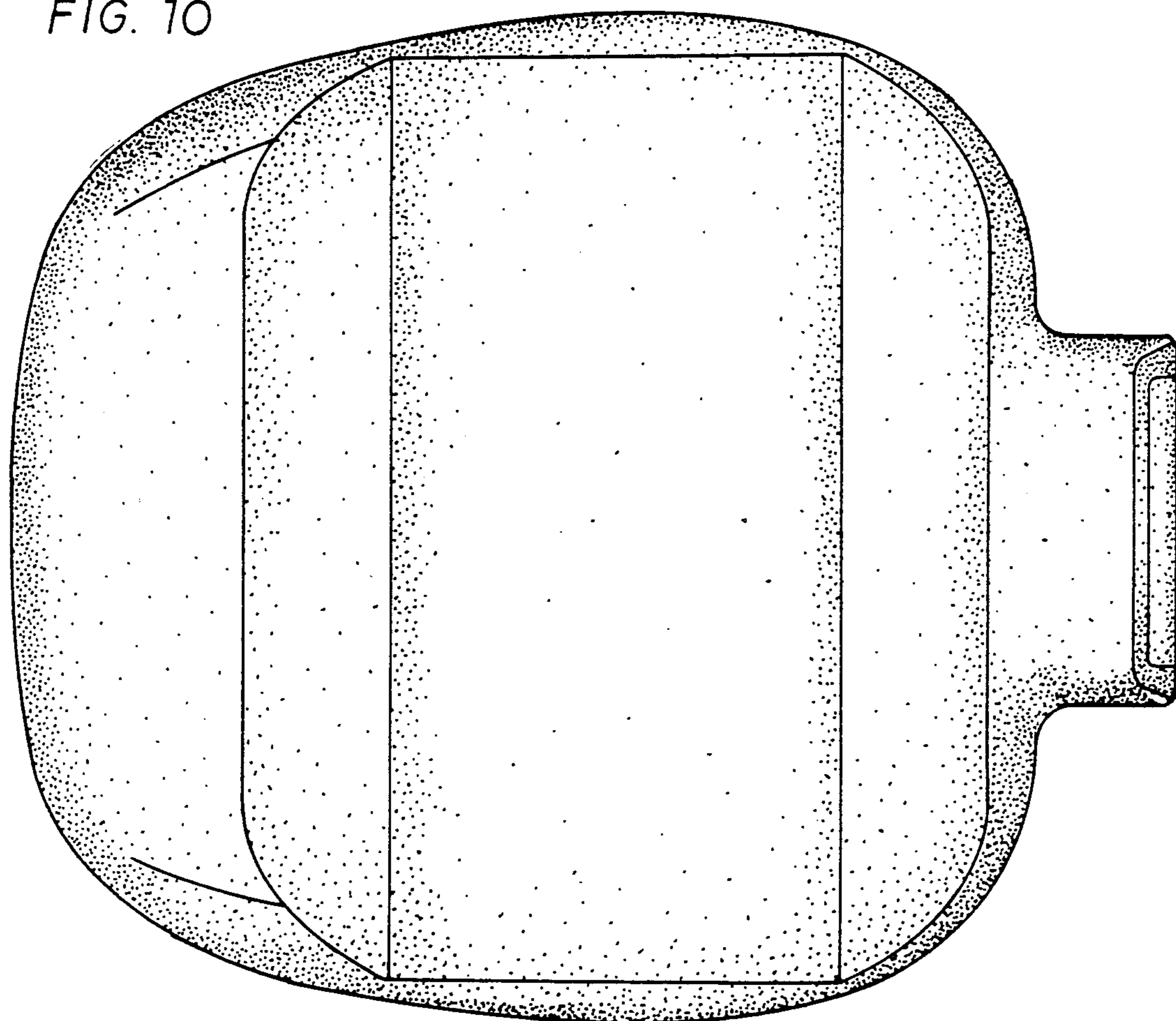

FIG. 10

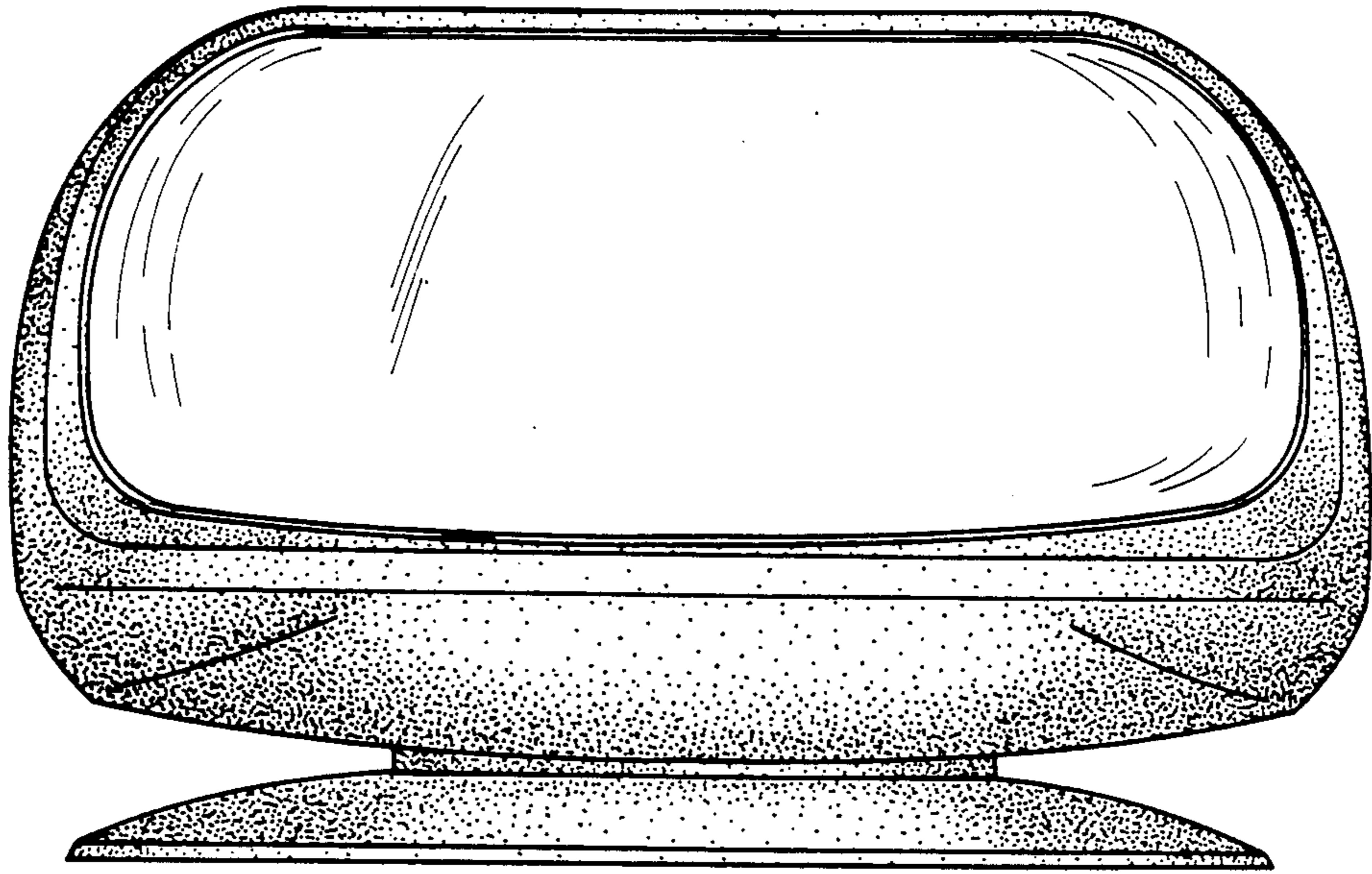

FIG. 11

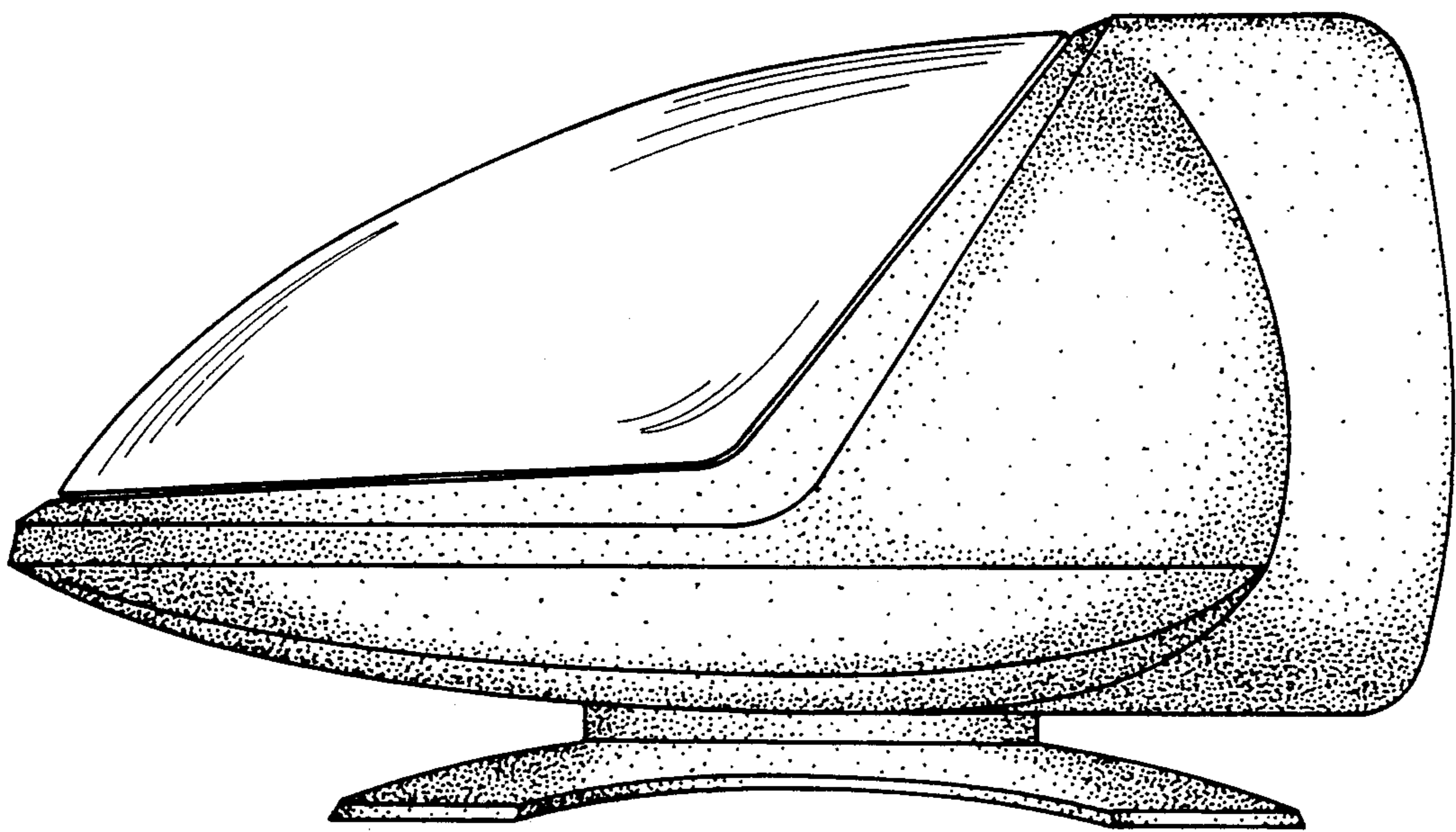

FIG. 12