

[54] PEDIATRIC SCALE
 [75] Inventor: Walter P. Kushmuk, Niles, Ill.
 [73] Assignee: Continental Scale Corporation,
 Bridgeview, Ill.
 [**] Term: 14 Years
 [21] Appl. No.: 230,152
 [22] Filed: Aug. 8, 1988
 [52] U.S. Cl. D10/91
 [58] Field of Search D10/87, 88, 89, 90,
 D10/91, 92, 93, 94, 95; 177/153, 210 R, 210 C,
 210 EM, 210 FR, 211, 212, 213, 214, 215, 238,
 239, 240, 241, 242, 243, 245, 262, DIG. 3, DIG.
 5

1,886,958 11/1932 Ithem 177/262
 2,931,640 4/1960 Riddle, Jr. 177/262
 4,253,534 3/1981 Hall et al. 177/241
 4,363,371 12/1982 Hutchinson D10/91 X

FOREIGN PATENT DOCUMENTS

769970 8/1934 France 177/262

Primary Examiner—Nelson C. Holtje
 Assistant Examiner—Antoine D. Davis
 Attorney, Agent, or Firm—Dick and Harris

[57] CLAIM

The ornamental design for an pediatric scale, as shown and described.

DESCRIPTION

FIG. 1 is a front elevational view of a pediatric scale showing my new design;
 FIG. 2 is a right side elevational view;
 FIG. 3 is a left side elevational view;
 FIG. 4 is a rear elevational view;
 FIG. 5 is a top plan view; and
 FIG. 6 is a bottom plan view thereof.

[56] References Cited
 U.S. PATENT DOCUMENTS

D. 146,154 12/1946 Preble, Jr. D10/91
 D. 245,675 9/1977 Kushmuk D10/91
 D. 254,427 3/1980 Perrier D10/91
 1,275,911 8/1918 Hansen 177/262

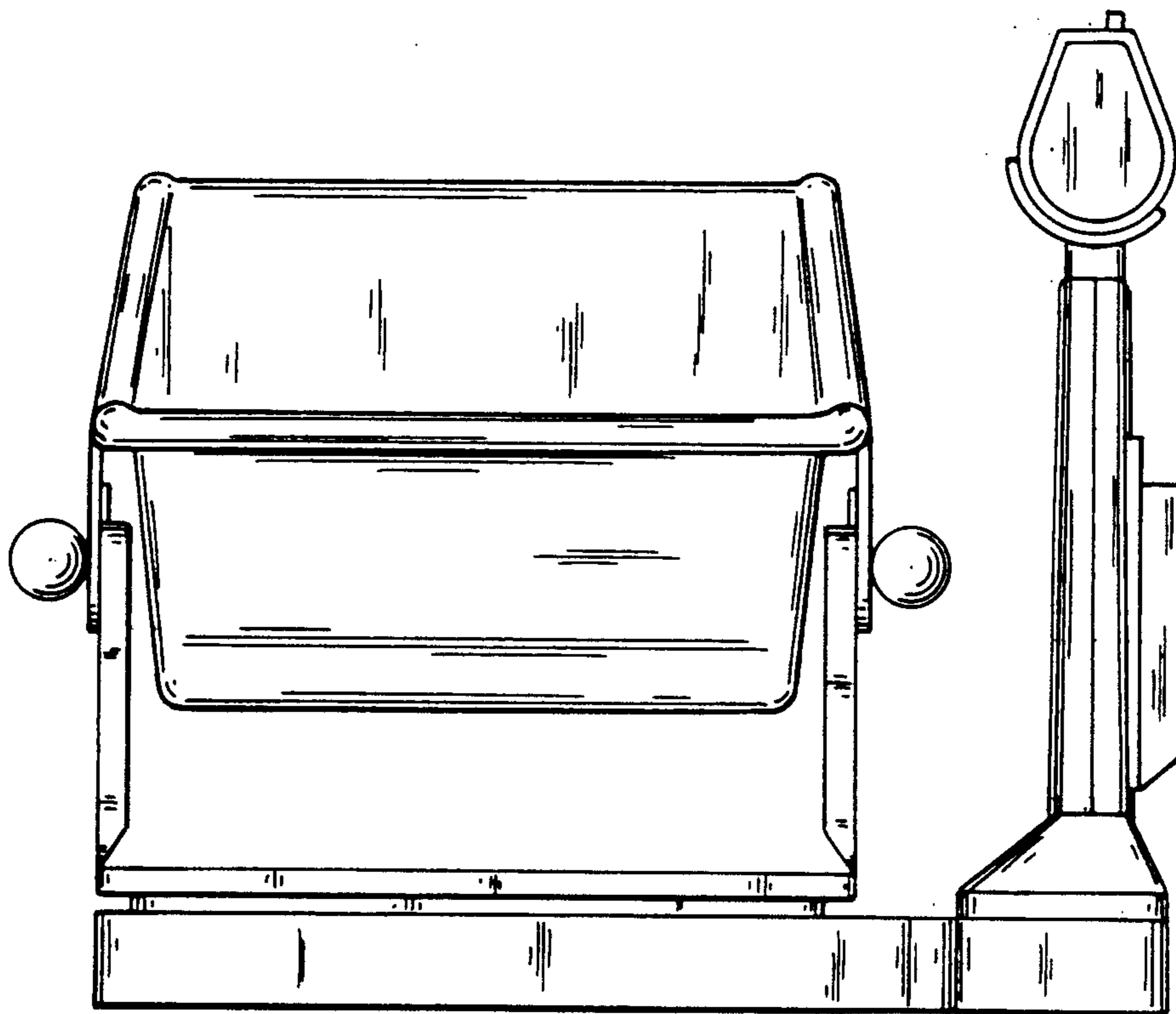

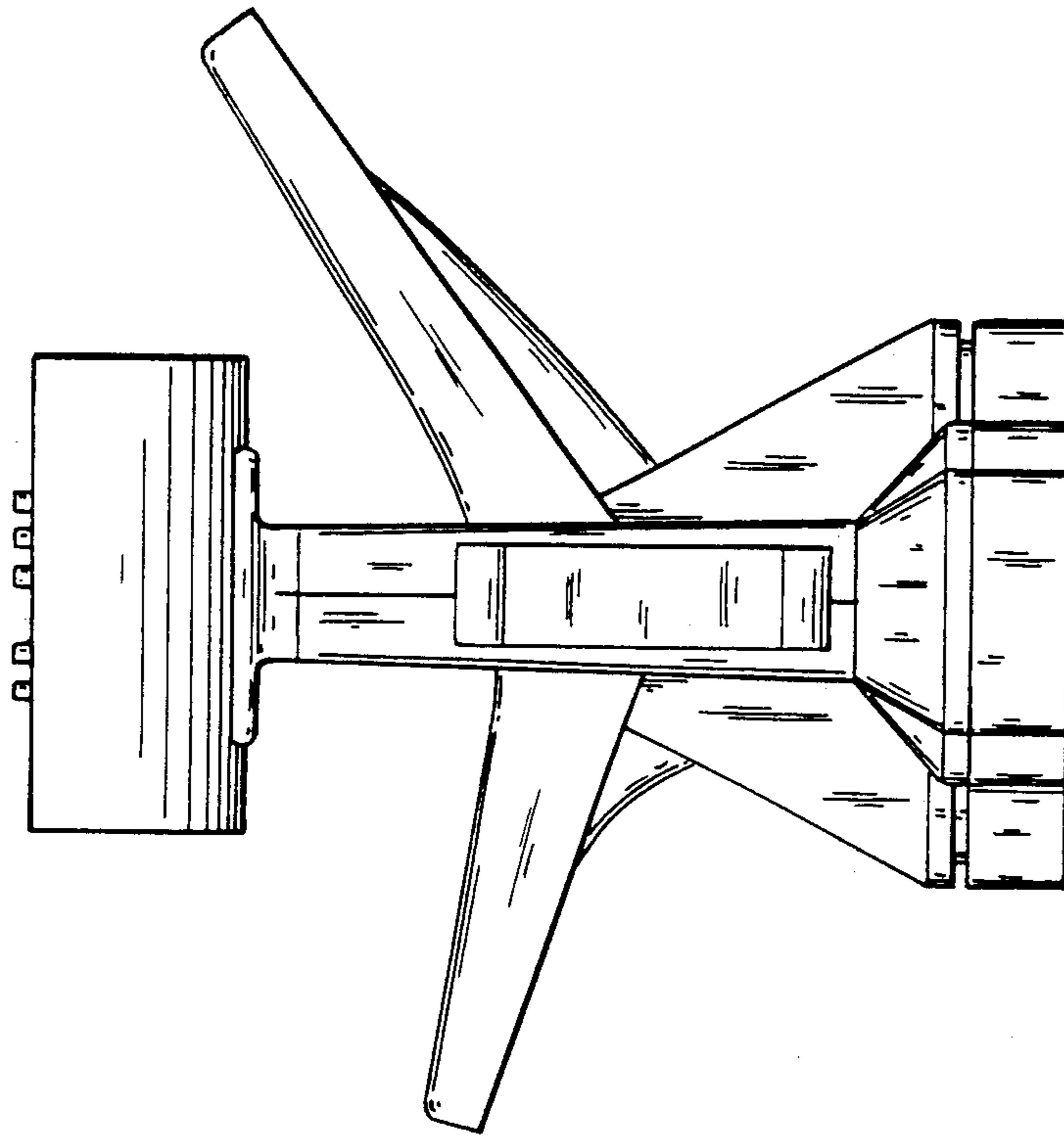

FIG. 2

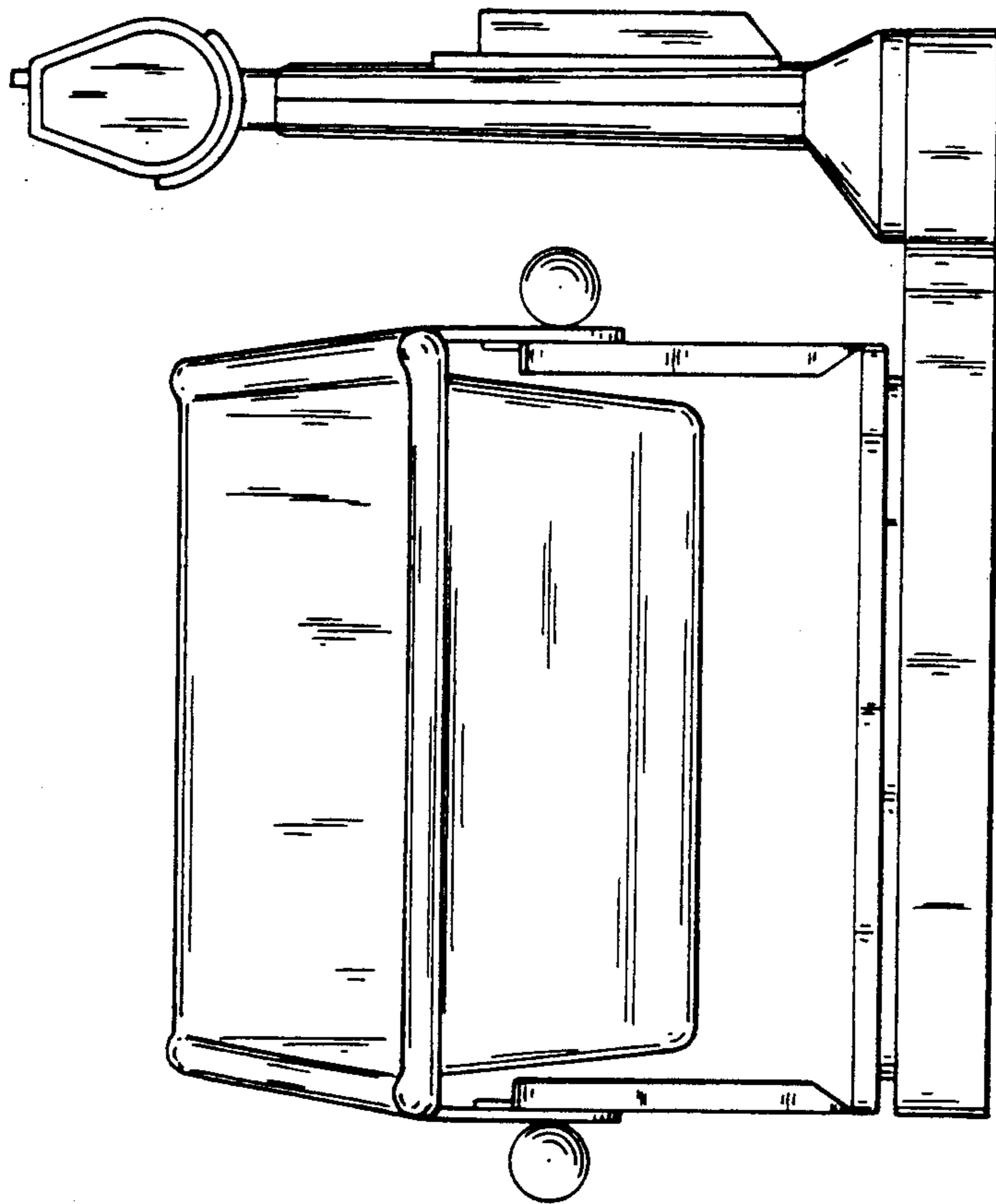

FIG. 1

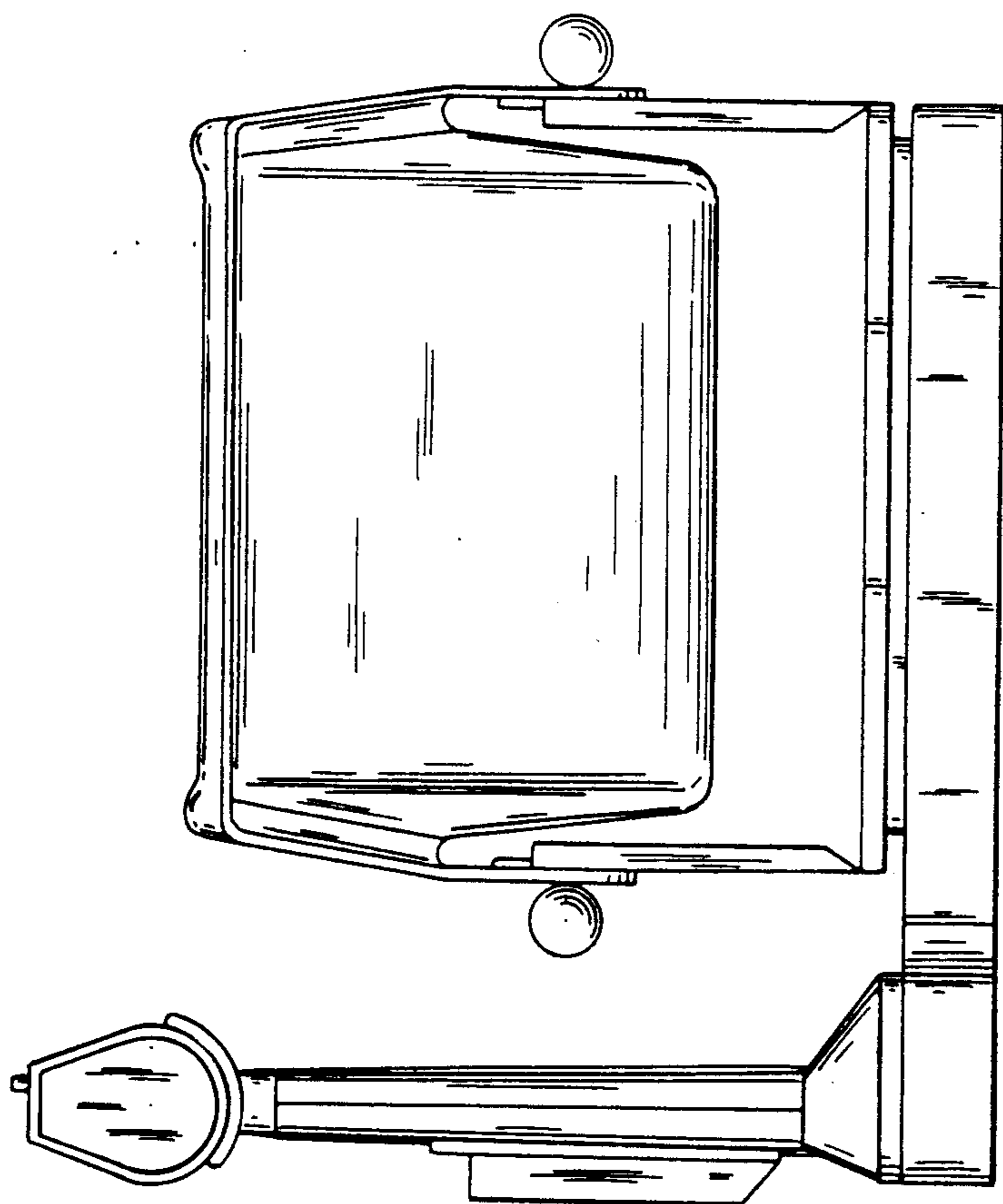

FIG.4

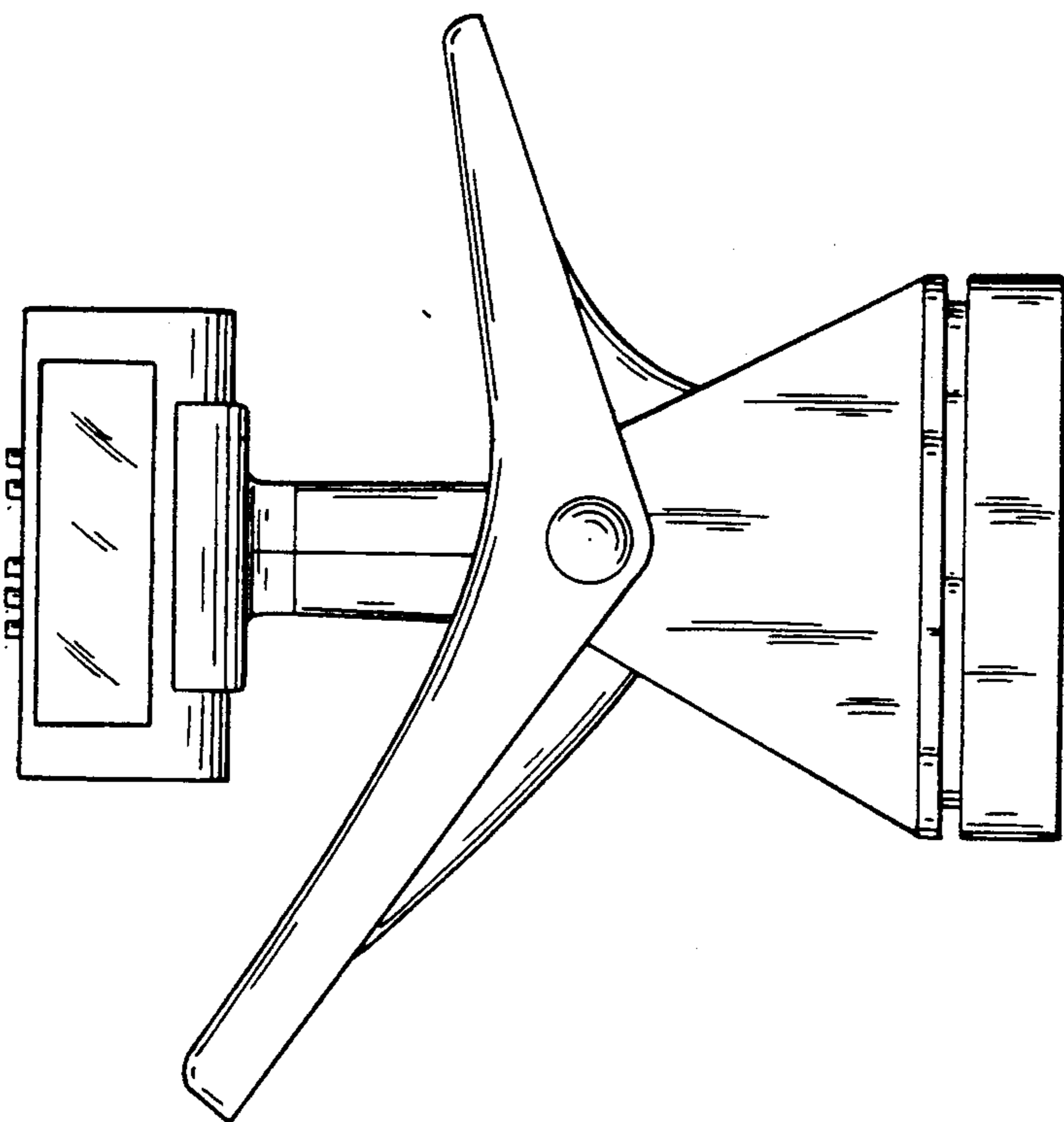

FIG.3

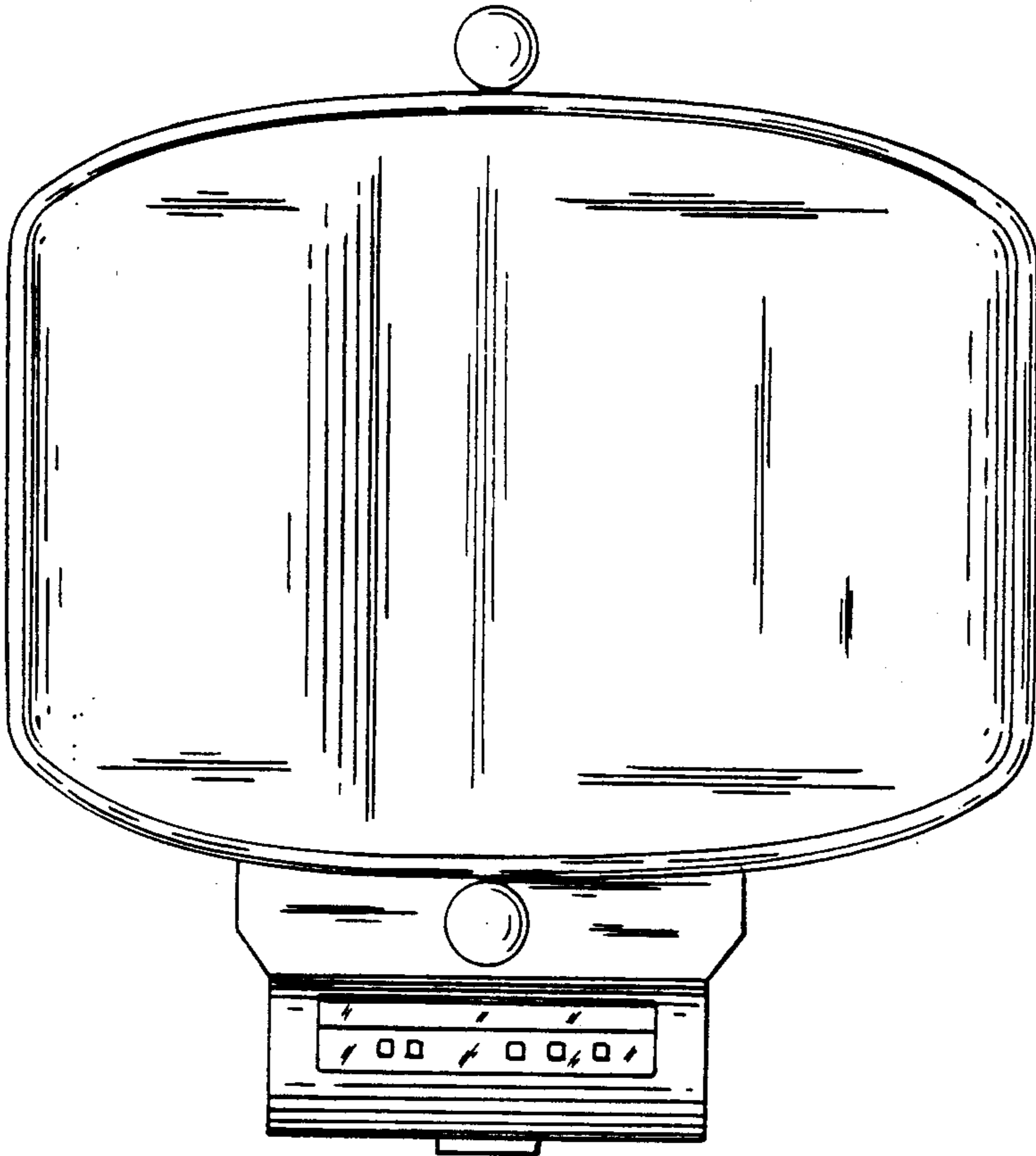

FIG. 5

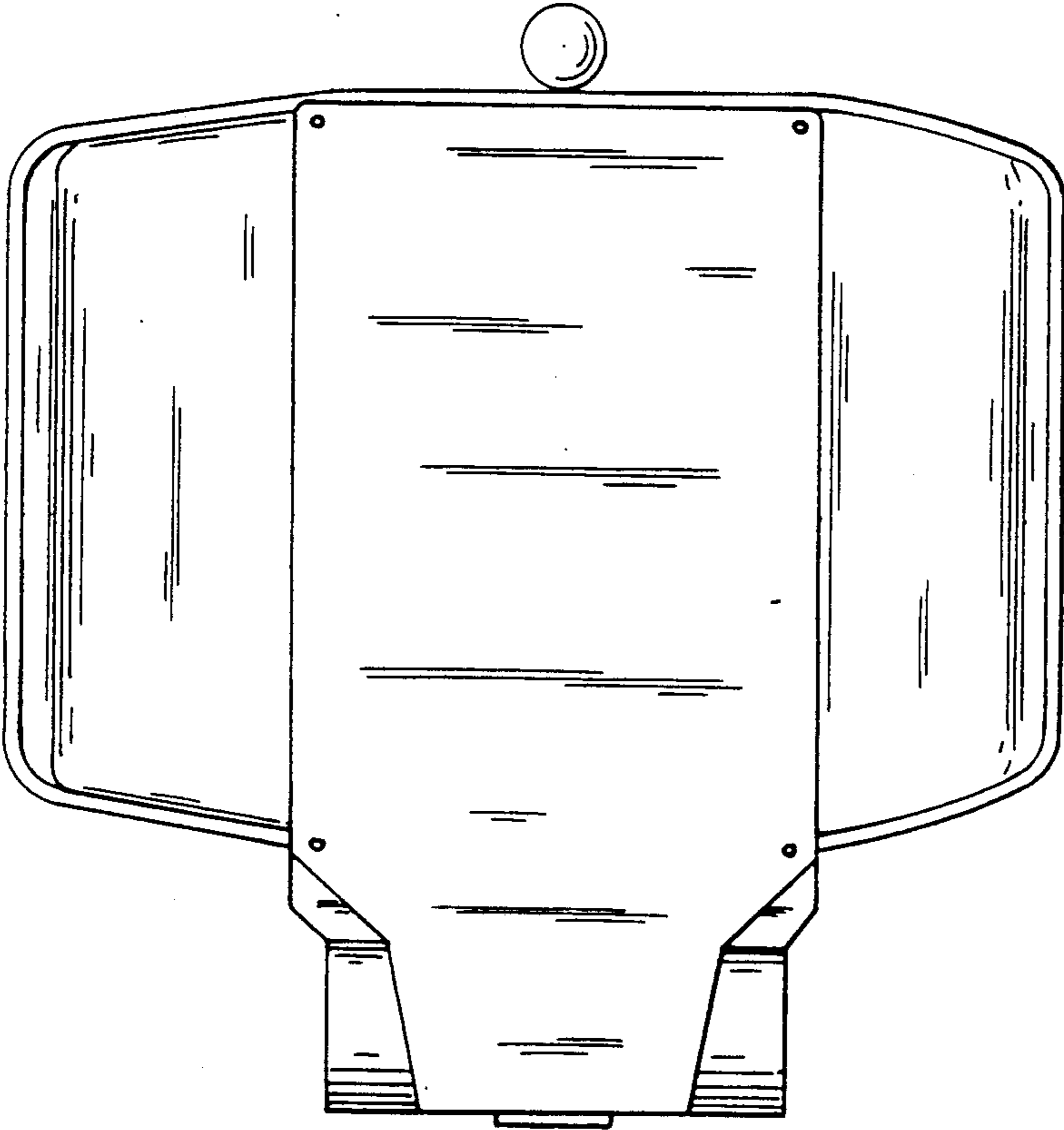

FIG. 6