

[54] CHAIR FRAME

[75] Inventor: Jun Kamahara, 2-17, Ihkura 4-chome, Sawaraku, Fukuoka-shi, Fukuoka-ken, Japan

[73] Assignee: Jun Kamahara, Fukuoka, Japan

[\*\*] Term: 14 Years

[21] Appl. No.: 172,907

[22] Filed: Mar. 22, 1988

[30] Foreign Application Priority Data

Mar. 15, 1988 [JP] Japan ..... 63-010543

[52] U.S. Cl. .... D6/500; D6/363

[58] Field of Search ..... D6/379, 363, 374, 500, D6/501, 502, 365, 495, 484

[56] References Cited

U.S. PATENT DOCUMENTS

- D. 48,030 10/1915 Herhold ..... D6/363
- D. 141,888 7/1945 Loman ..... D6/495
- D. 180,935 9/1957 de Swart ..... D6/363
- D. 183,478 9/1958 Cohen ..... D6/363
- D. 195,257 5/1963 Andersen et al. .... D6/379
- D. 234,105 1/1975 Katoda ..... D6/363 X

OTHER PUBLICATIONS

Industrial Design, Nov./Dec. 1977, p. 47, portable chair, lower left.

Interiors, May 1981, p. 19, the ribbonback chair, center column.

Illums Bolighus—Center of Modern Design, May 1961, p. 4, dining chair 34148.

Illums Bolighus—Center of Modern Design, May 1961, p. 10, dining chair 34002 (far left).

Identkit chair book, Abitare, May 1985, p. 81, PK 11 chair.

Primary Examiner—Bruce W. Dunkins

Assistant Examiner—Janice E. Seeger

Attorney, Agent, or Firm—Jordan and Hamburg

[57] CLAIM

The ornamental design for a chair frame, as shown and described.

DESCRIPTION

FIG. 1 is a front elevational view of a chair frame, showing my new design;

FIG. 2 is a rear elevational view;

FIG. 3 is a cross sectional view along the lines A—A of FIG. 1;

FIG. 4 is a top plan view;

FIG. 5 is a bottom plan view;

FIG. 6 is a right side elevational view; and

FIG. 7 is a perspective view, the broken lines being for illustrative purposes only.

As left and right side views are symmetrical, the left side view has been omitted.

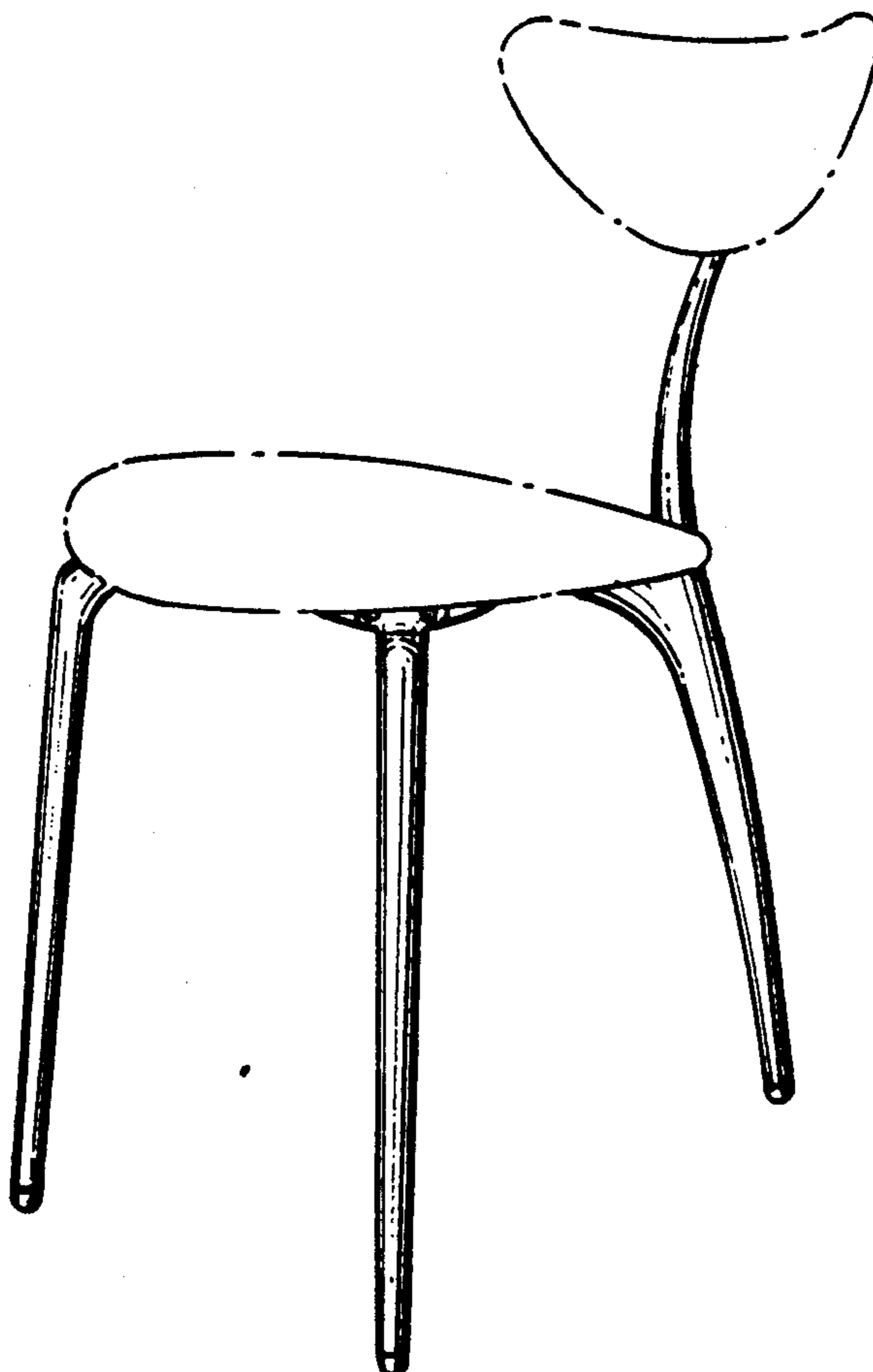

*FIG. 1*

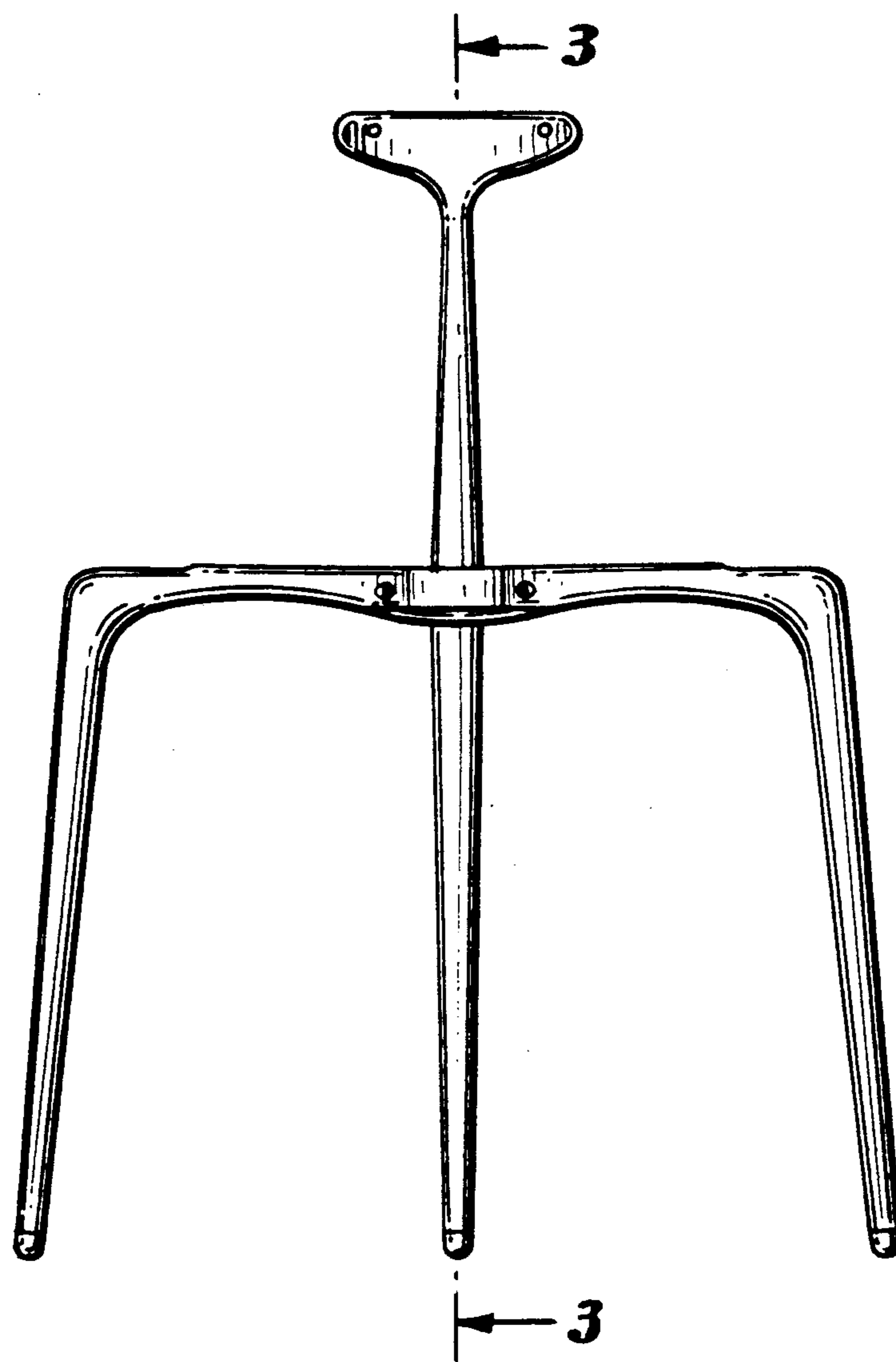

FIG. 3

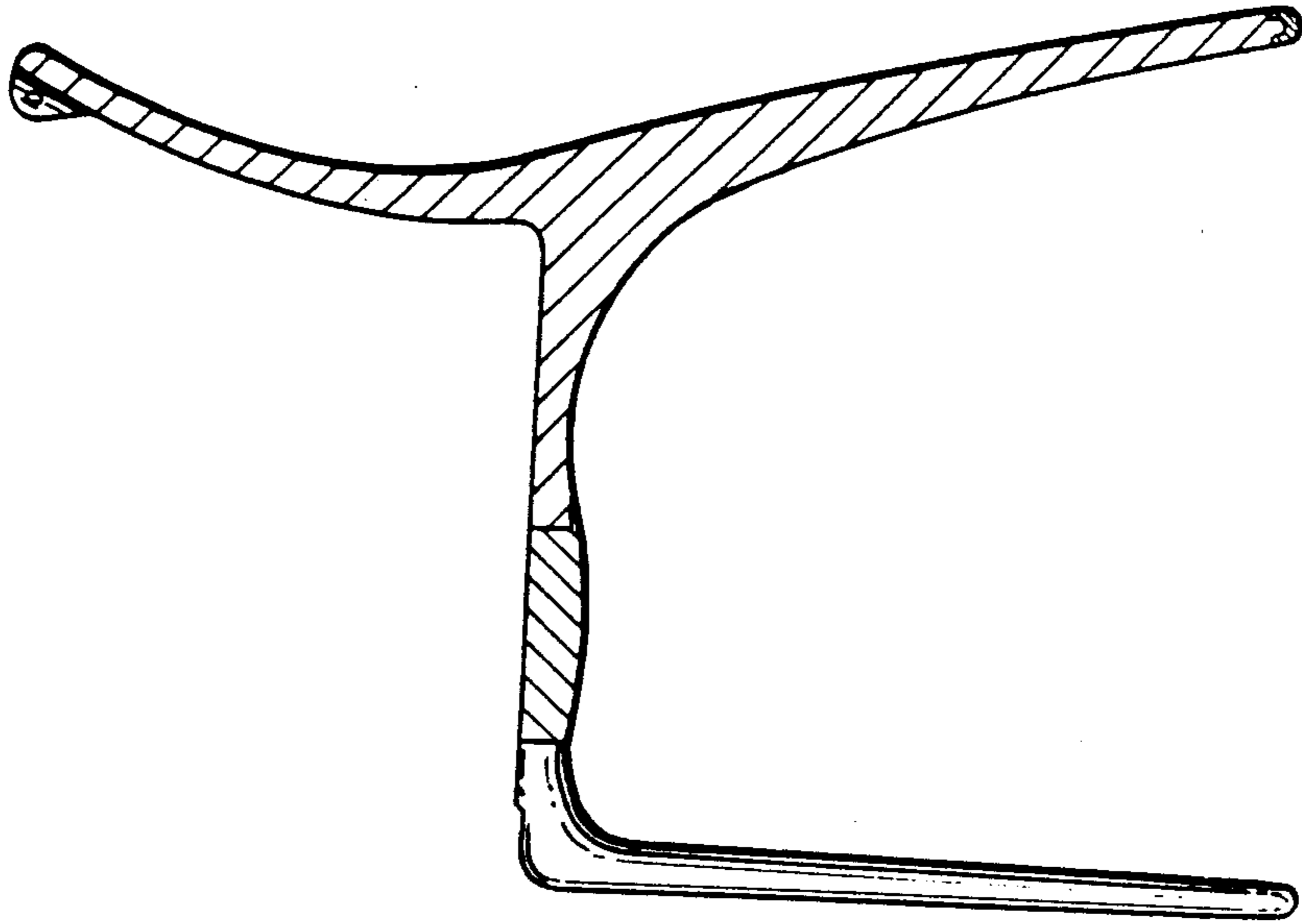
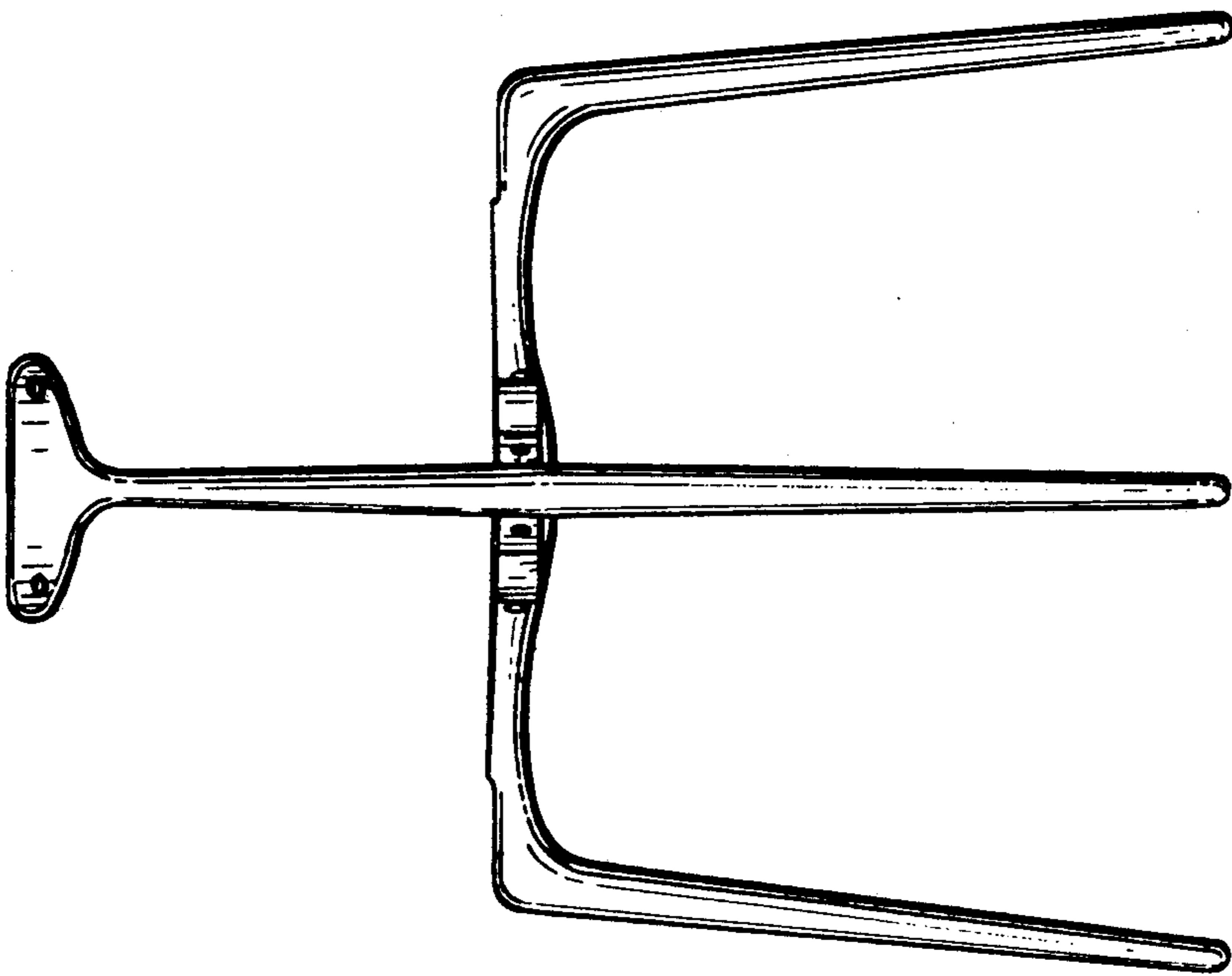
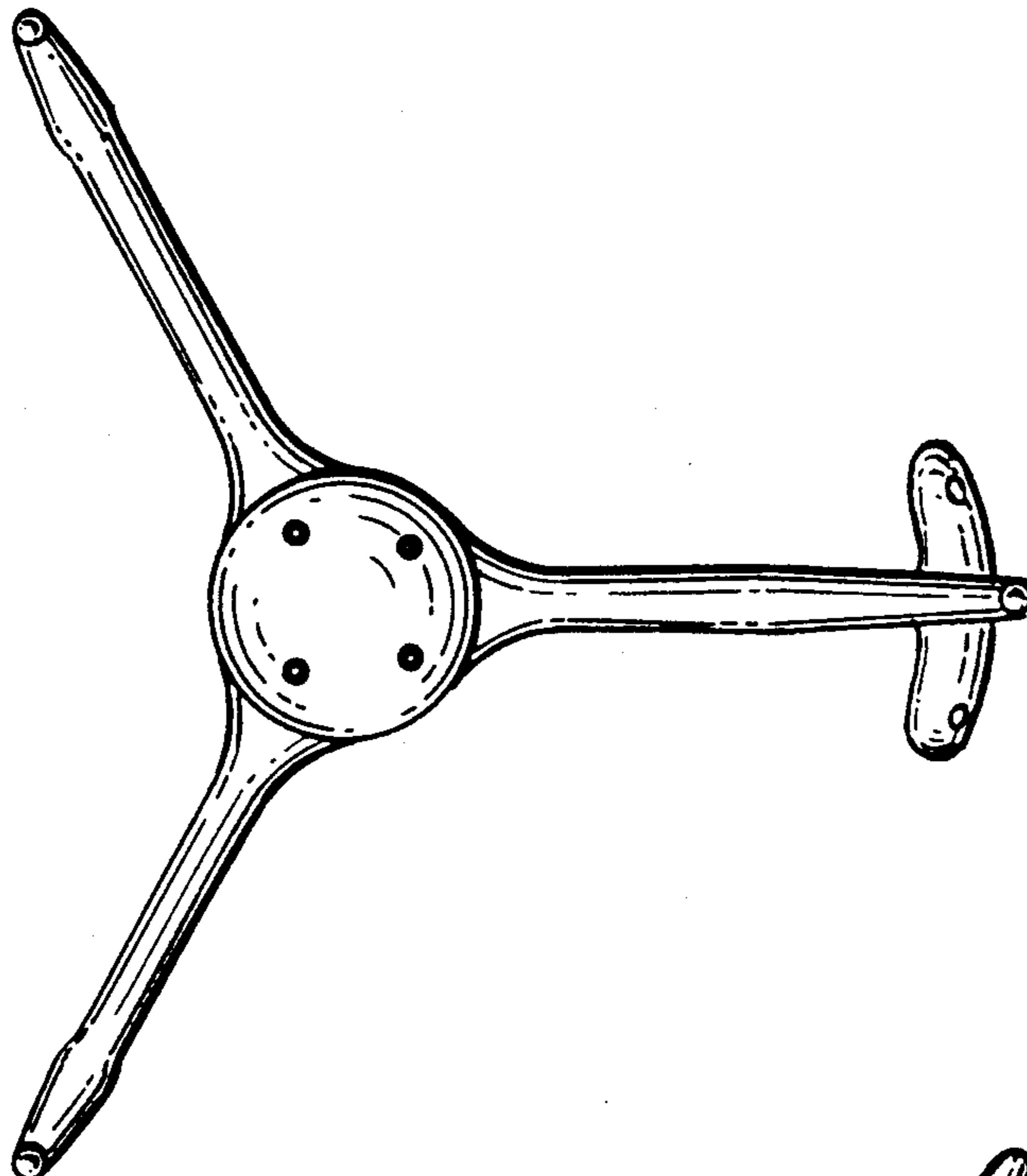
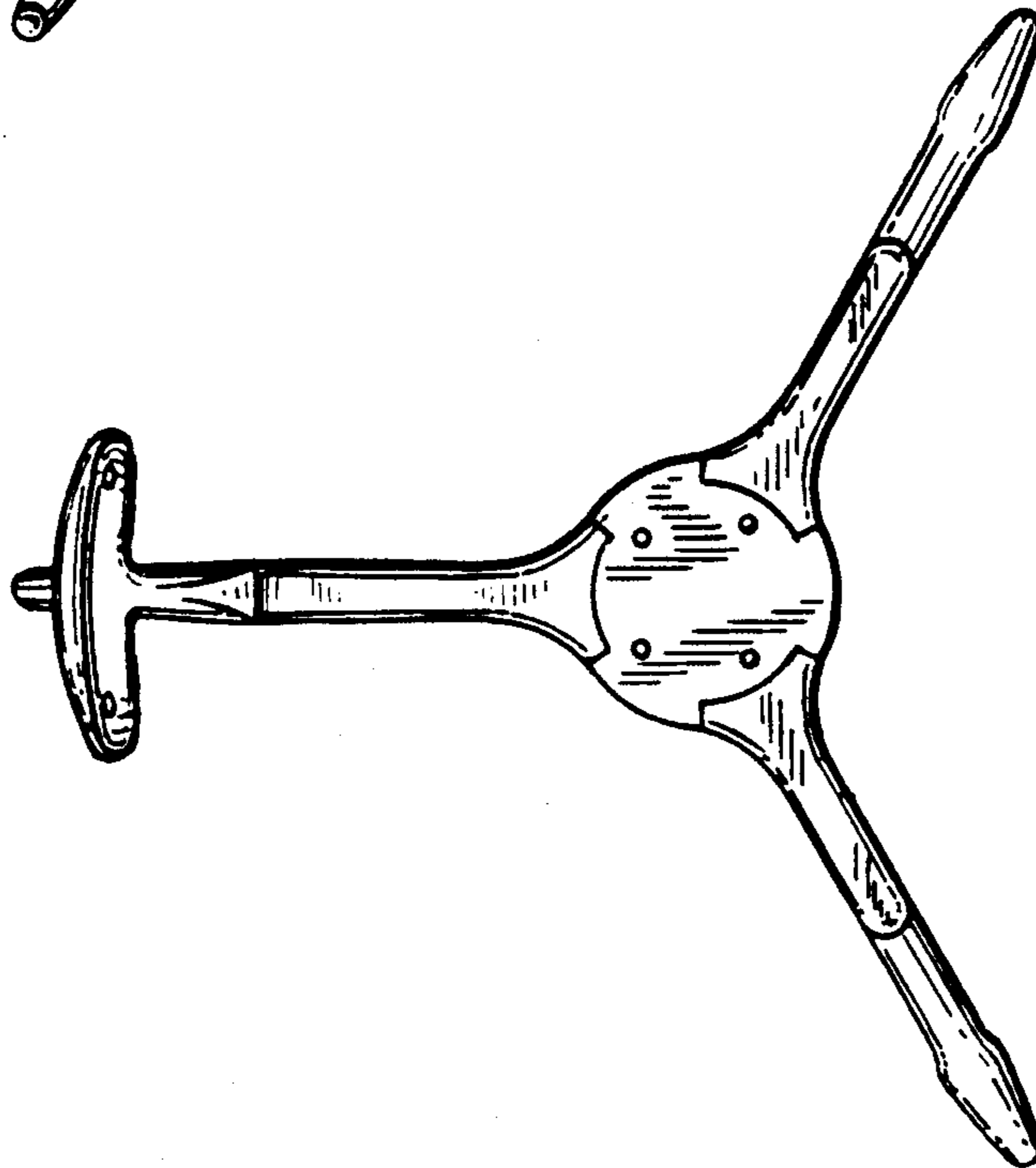

FIG. 2



*FIG. 4*



*FIG. 5*

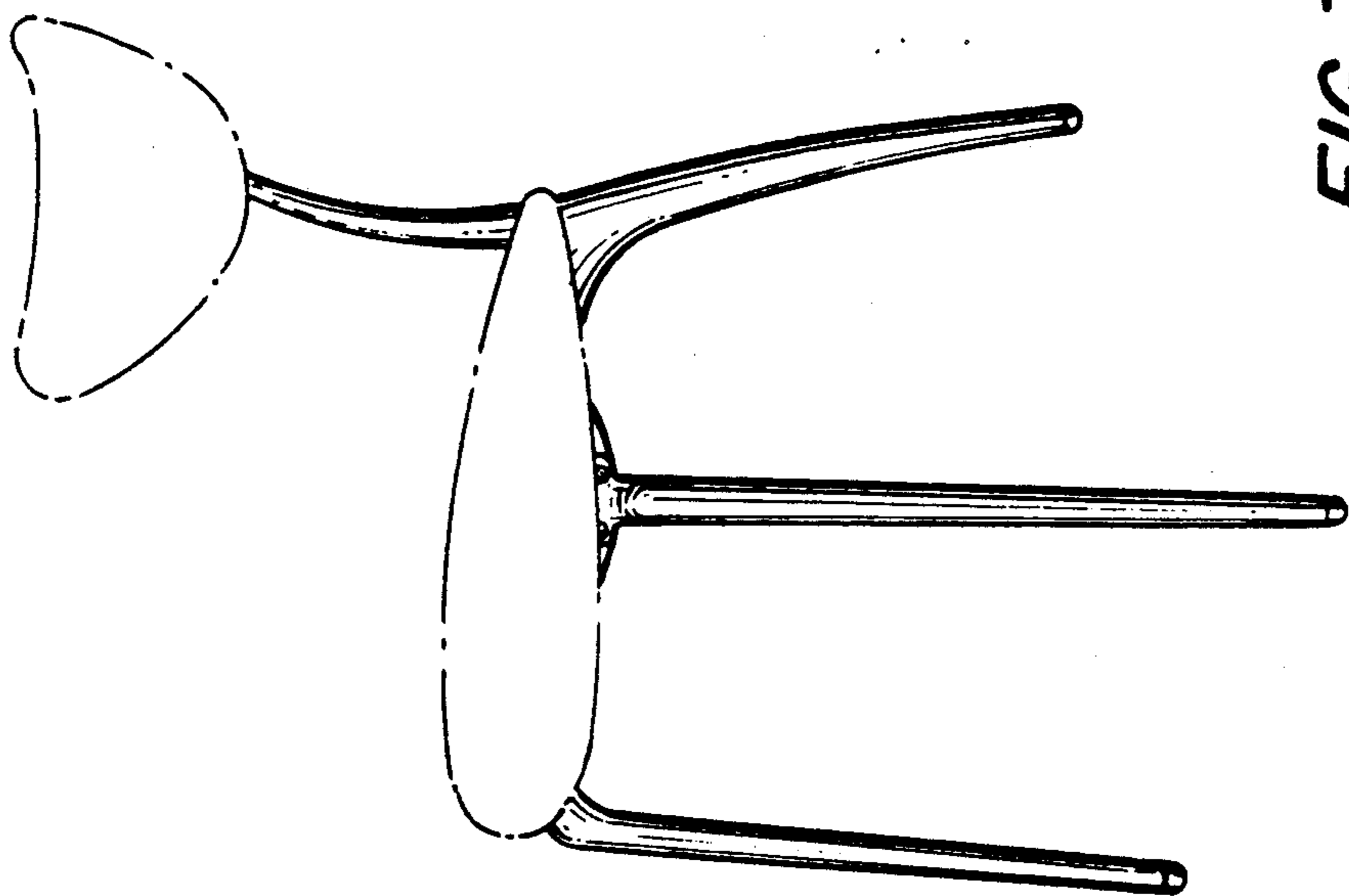

FIG. 7

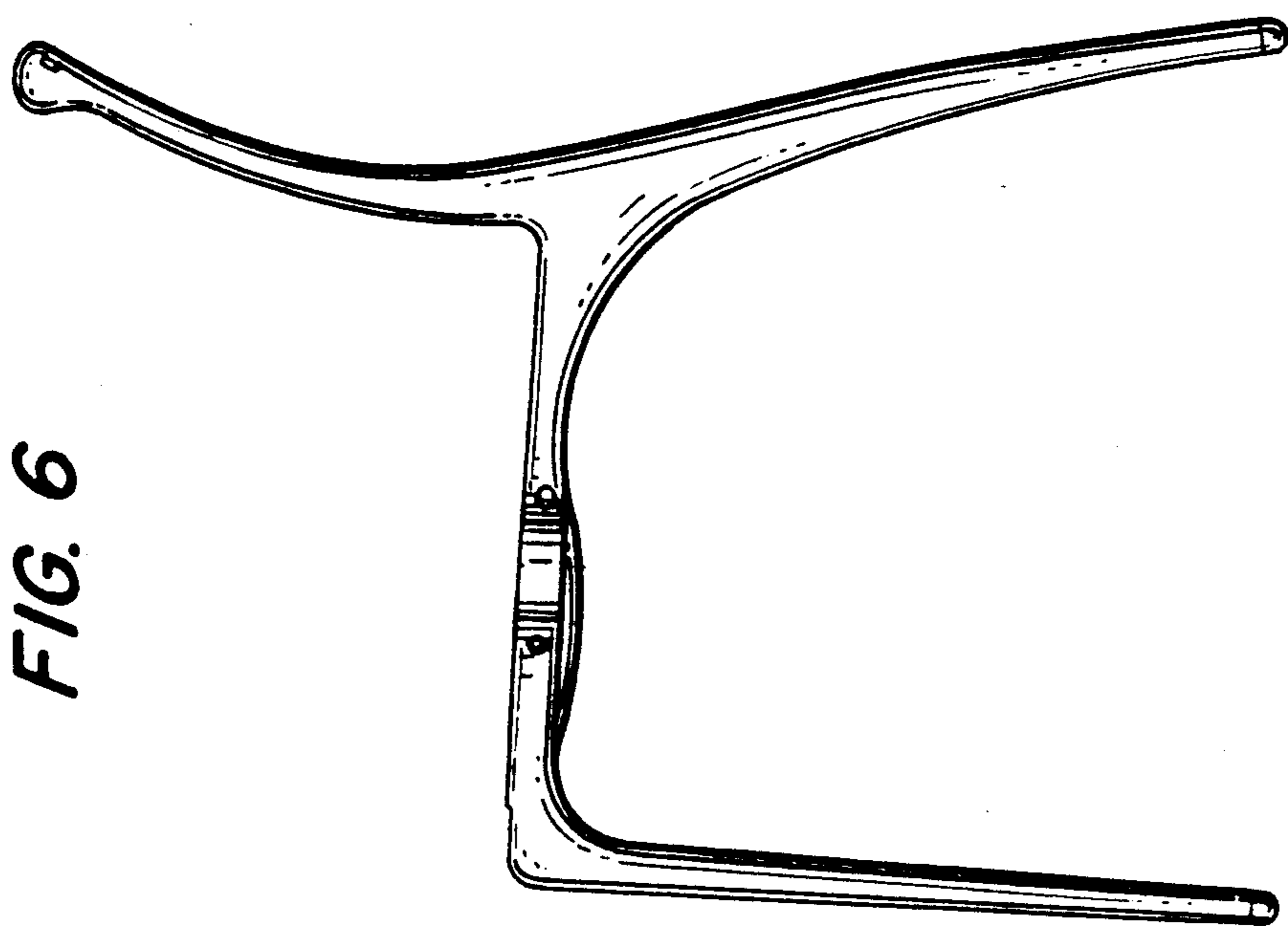

FIG. 6