

[54] INFLATABLE INSERT FOR TRAVEL BAGS

4,569,082 2/1986 Ainsworth et al. 383/3

[75] Inventors: Marshall Frey, Ossining; Thomas Scheuer, East Williston, both of N.Y.

Primary Examiner—Louis S. Zarfes
Attorney, Agent, or Firm—Salter & Michaelson

[73] Assignee: Airelle Industries, Inc., Mount Vernon, N.Y.

[57] CLAIM

The ornamental design for an inflatable insert for travel bags, as shown and described.

[**] Term: 14 Years

DESCRIPTION

[21] Appl. No.: 139,864

[22] Filed: Dec. 30, 1987

[52] U.S. Cl. D3/54

[58] Field of Search D3/41-54;
150/100; 190/100, 107, 110; 383/3, 12, 104, 110

FIG. 1 is a perspective view of an inflatable insert for travel bags showing our new design;
FIG. 2 is a side elevational view thereof, it being understood that the opposite side is a mirror image thereof;
FIG. 3 is a top plan view thereof;
FIG. 4 is an end elevational view thereof, it being understood that the opposite end is a mirror image thereof;
FIG. 5 is a bottom plan view thereof; and
FIG. 6 is a perspective view showing the interior of the two walls not visible in FIG. 1.

[56] References Cited

U.S. PATENT DOCUMENTS

D. 265,149 6/1982 Romano D3/53
2,911,024 11/1959 Miceli D3/54 X

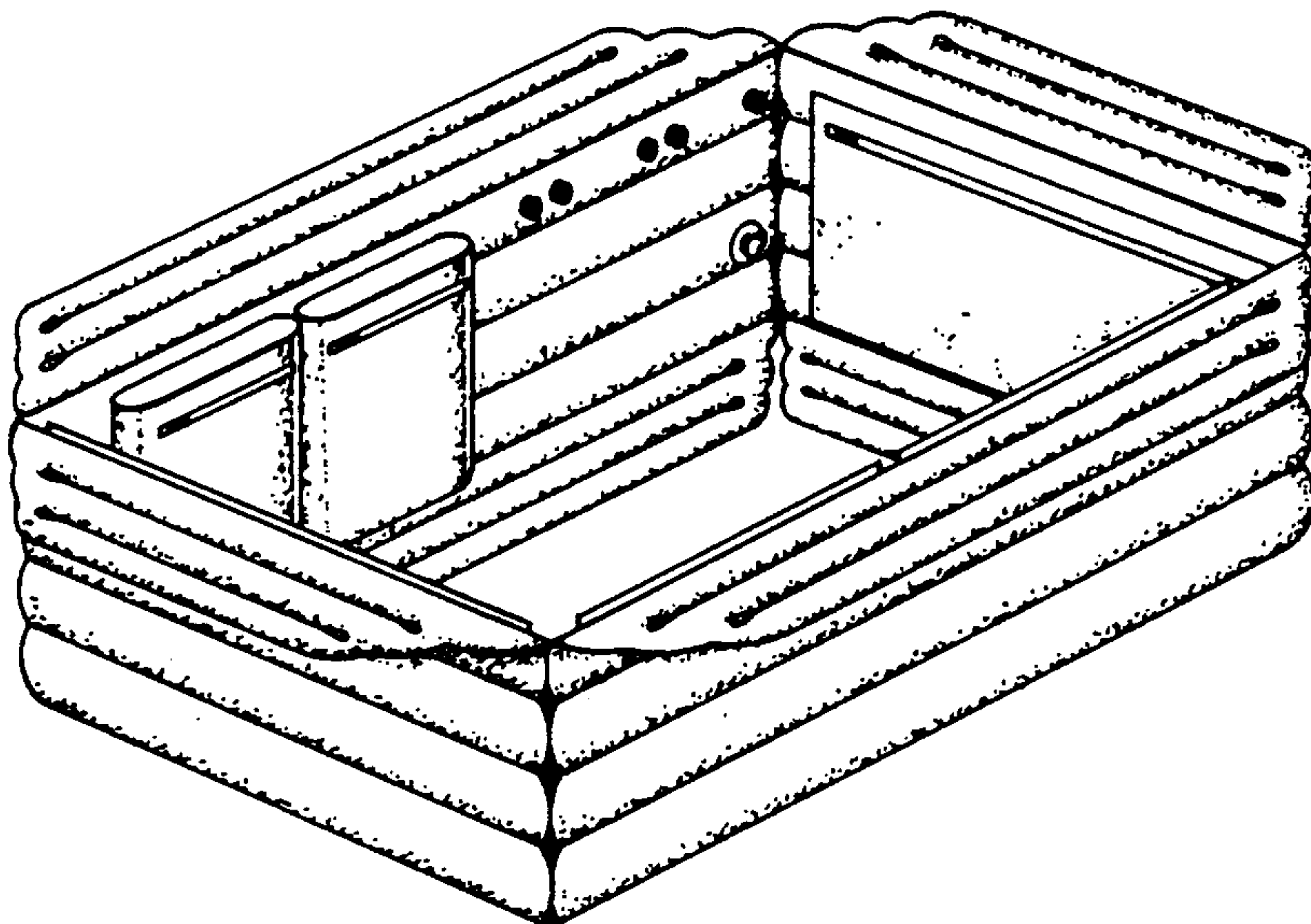

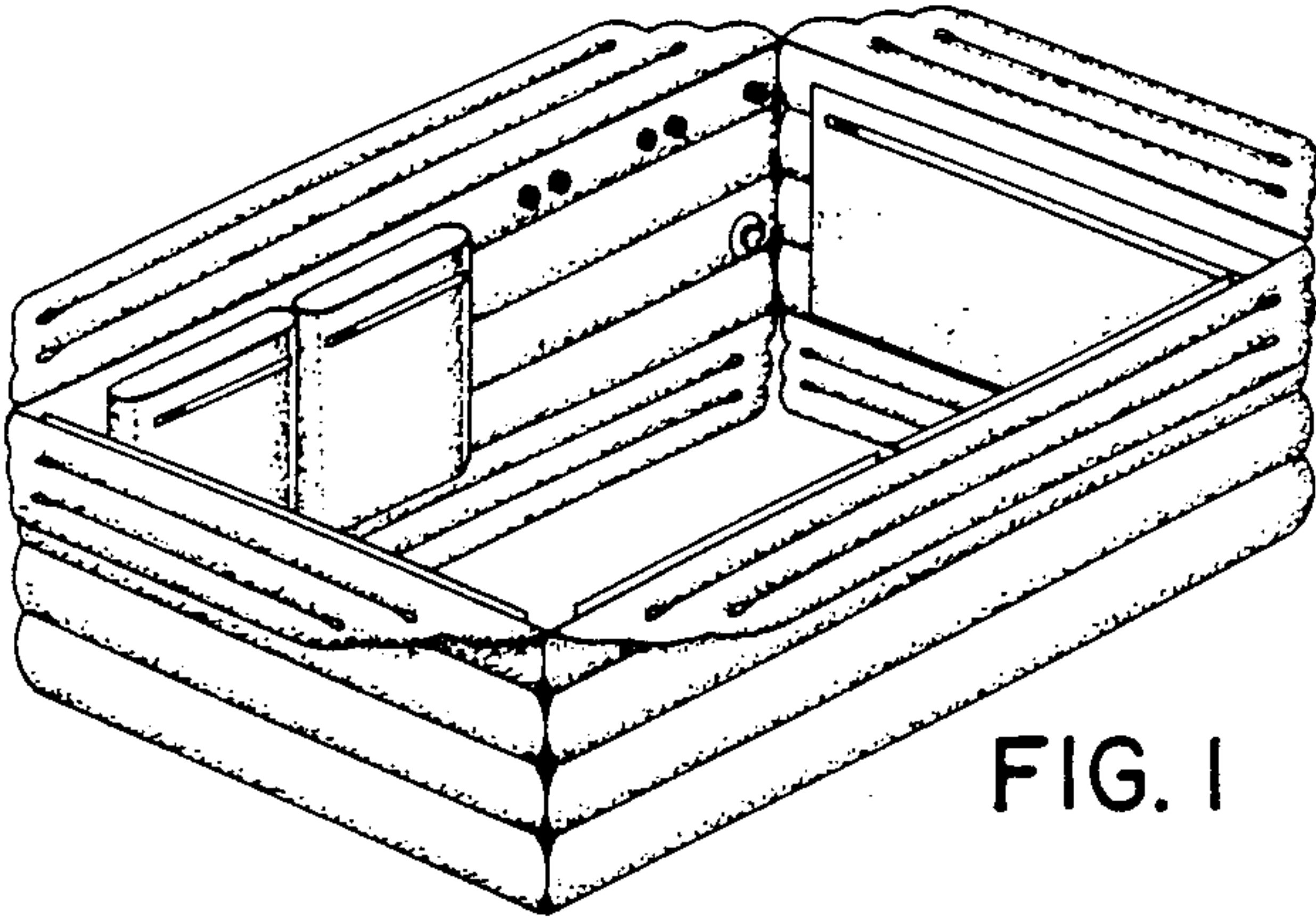

FIG. 1

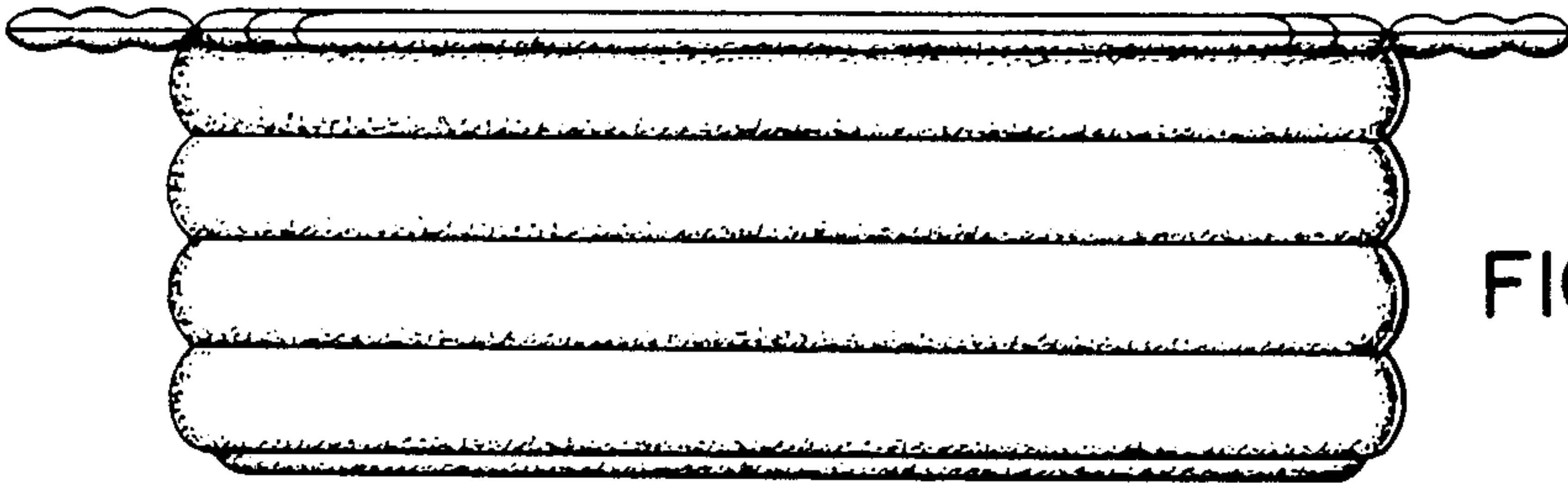

FIG. 2

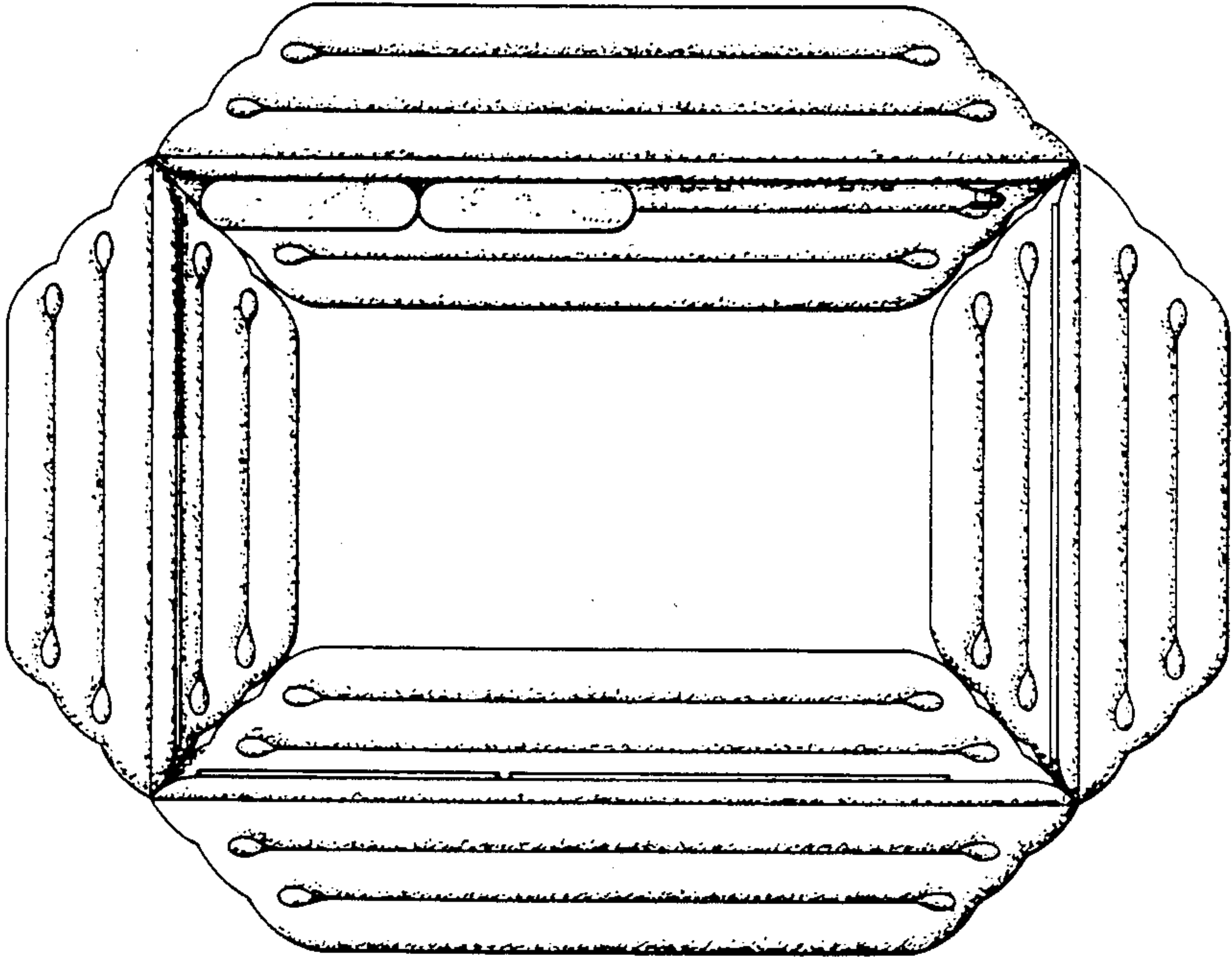

FIG. 3

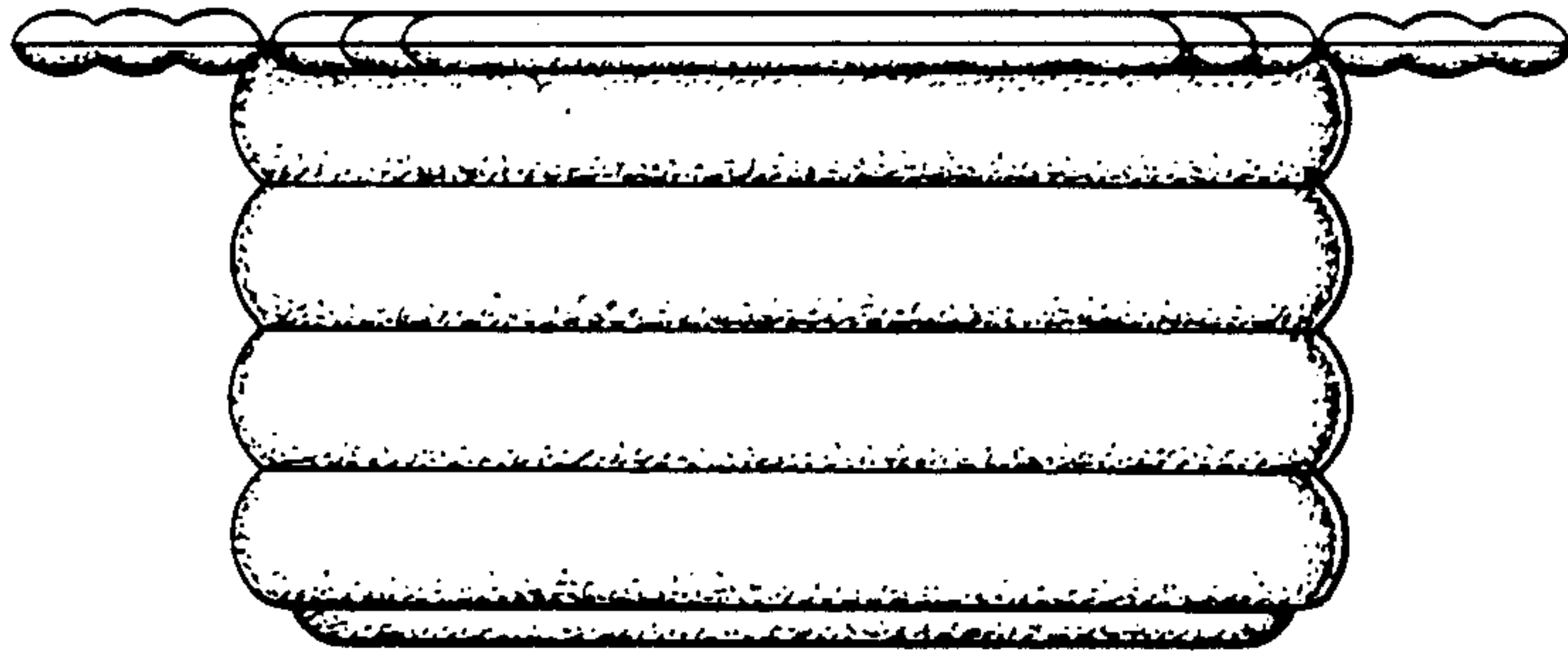

FIG. 4

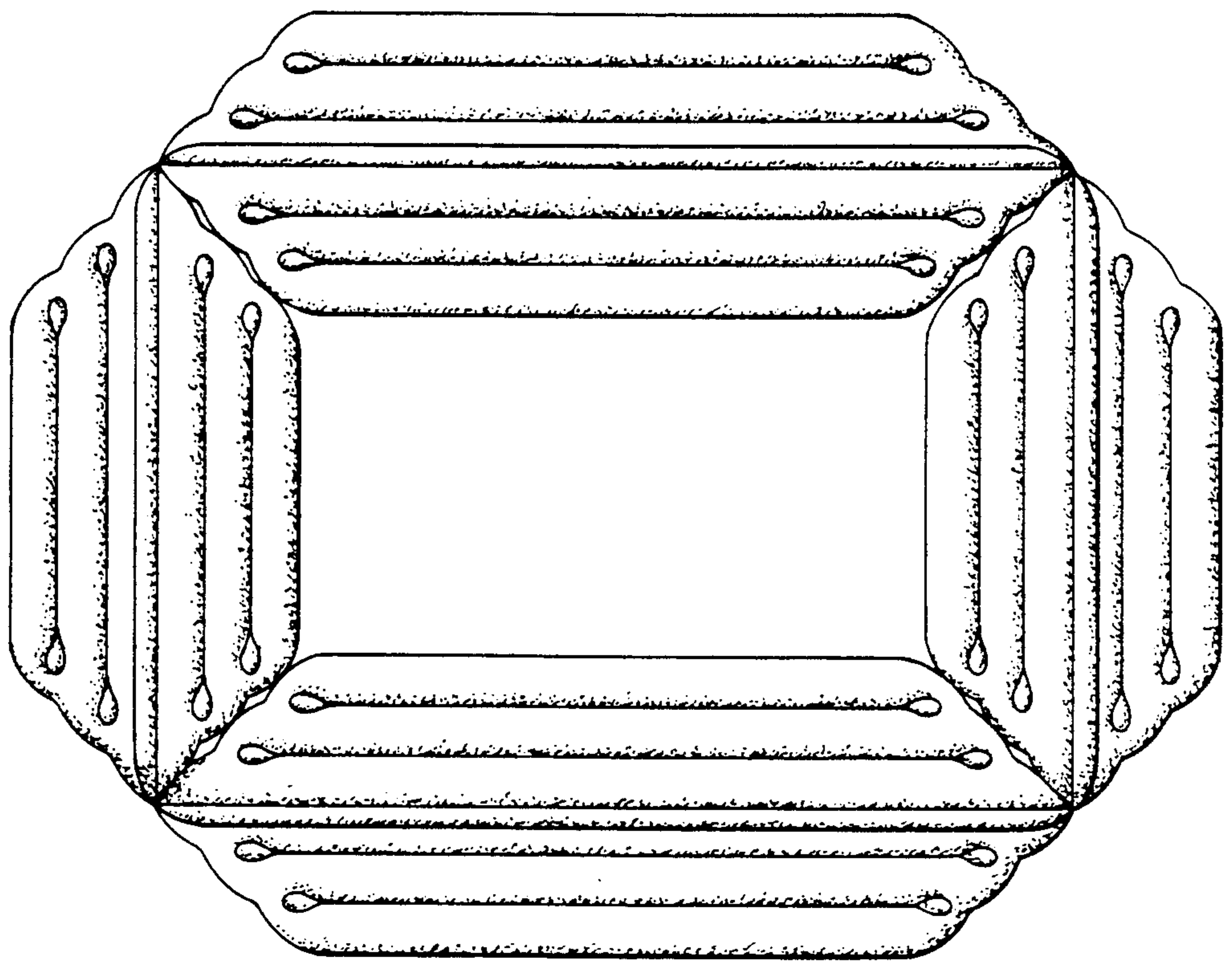

FIG. 5

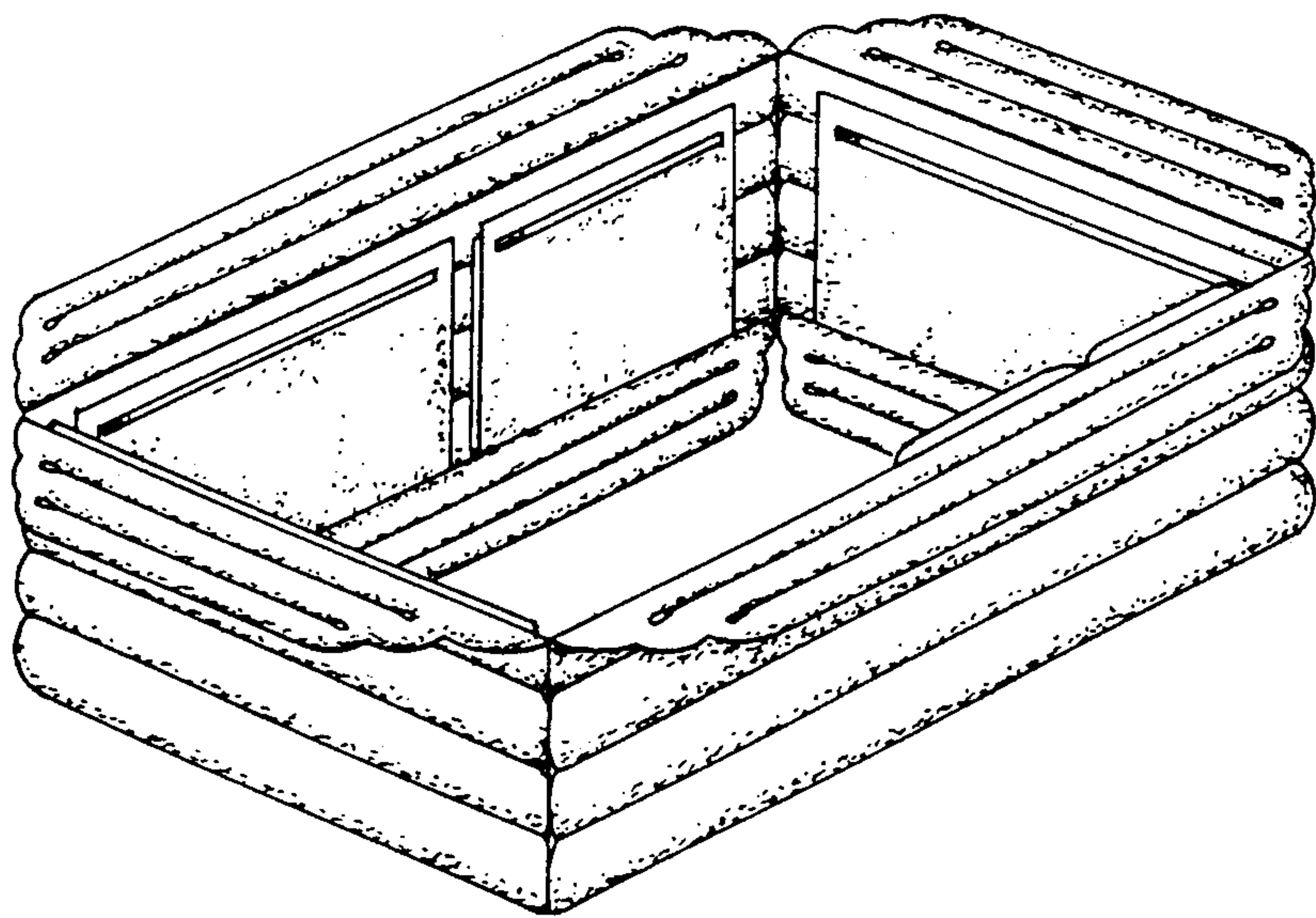

FIG. 6