

[54] SHELF UNIT

[75] Inventor: Peter M. Yau Kee, Happy Valley, Hong Kong

[73] Assignee: Rosalco, Inc., Louisville, Ky.

[\*] Notice: The portion of the term of this patent subsequent to Jun. 26, 2004 has been disclaimed.

[\*\*] Term: 14 Years

[21] Appl. No.: 471,362

[22] Filed: Jan. 26, 1990

Related U.S. Application Data

[62] Division of Ser. No. 295,474, Jan. 10, 1989.

[52] U.S. Cl. .... D6/465; D6/474

[58] Field of Search ..... D6/462, 464, 465, 474, D6/477, 479; 211/182

[56] References Cited

U.S. PATENT DOCUMENTS

- D. 191,249 8/1961 Gardner et al. .... D6/474
- D. 244,982 7/1977 Parra ..... D6/474 X
- 4,821,893 4/1989 Wyatt ..... 211/182

OTHER PUBLICATIONS

W. Bell & Co. Catalog 1987; items 1 and 4. Furniture/Today; Apr. 18, 1988; Powell advertisement. Beagle Manuf. Co. Inc. catalog, p. 25. Beagle Manuf. Co. Inc. catalog, p. 15.

Primary Examiner—Bruce W. Dunkins

Assistant Examiner—Jeffrey Asch

Attorney, Agent, or Firm—Rhodes, Coats & Bennett

[57] CLAIM

The ornamental design for a shelf unit, as shown and described.

DESCRIPTION

FIG. 1 is a front perspective view of the shelf unit showing my new design in the form of a baker's rack; FIG. 2 is a rear perspective view of the shelf unit of FIG. 1; FIG. 3 is a front elevational view of the shelf unit of FIG. 1; FIG. 4 is a front perspective view showing a second

embodiment of the shelf unit of FIG. 1 in the form of a book case;

FIG. 5 is a rear perspective view of the shelf unit of FIG. 4;

FIG. 6 is a front elevational view of the shelf unit of FIG. 4;

FIG. 7 is a front perspective view of a third embodiment of the shelf unit of FIG. 1 in the form of a telephone stand;

FIG. 8 is a rear perspective view of the shelf unit of FIG. 7;

FIG. 9 is a front elevational view of the shelf unit of FIG. 7;

FIG. 10 is a front perspective view showing a fourth embodiment of the shelf unit of FIG. 1 in the form of an alternate baker's rack;

FIG. 11 is a rear perspective view of the shelf unit of FIG. 10;

FIG. 12 is a front elevational view of the shelf unit of FIG. 10;

FIG. 13 is a front perspective view of a fifth embodiment of the shelf unit of FIG. 1 in the form of an entertainment center;

FIG. 14 is a rear perspective view of the shelf unit of FIG. 13;

FIG. 15 is a front elevational view of the shelf unit of FIG. 13;

FIG. 16 is a front perspective view of a sixth embodiment of the shelf unit of FIG. 1 in the form of an etagere;

FIG. 17 is a rear perspective view of the shelf unit of FIG. 16;

FIG. 18 is a front elevational view of the shelf unit of FIG. 16;

FIG. 19 is a front perspective view of a seventh embodiment of the shelf unit of FIG. 1 in the form of an alternate etagere;

FIG. 20 is a rear perspective view of the shelf unit of FIG. 19;

FIG. 21 is a front elevational view of the shelf unit of FIG. 19;

FIG. 22 is a front perspective view showing an eighth embodiment of the shelf unit of FIG. 1 in the form of a television stand;

FIG. 23 is a rear perspective view of the shelf unit of FIG. 22; and

FIG. 24 is a front elevational view of the shelf unit of FIG. 22.

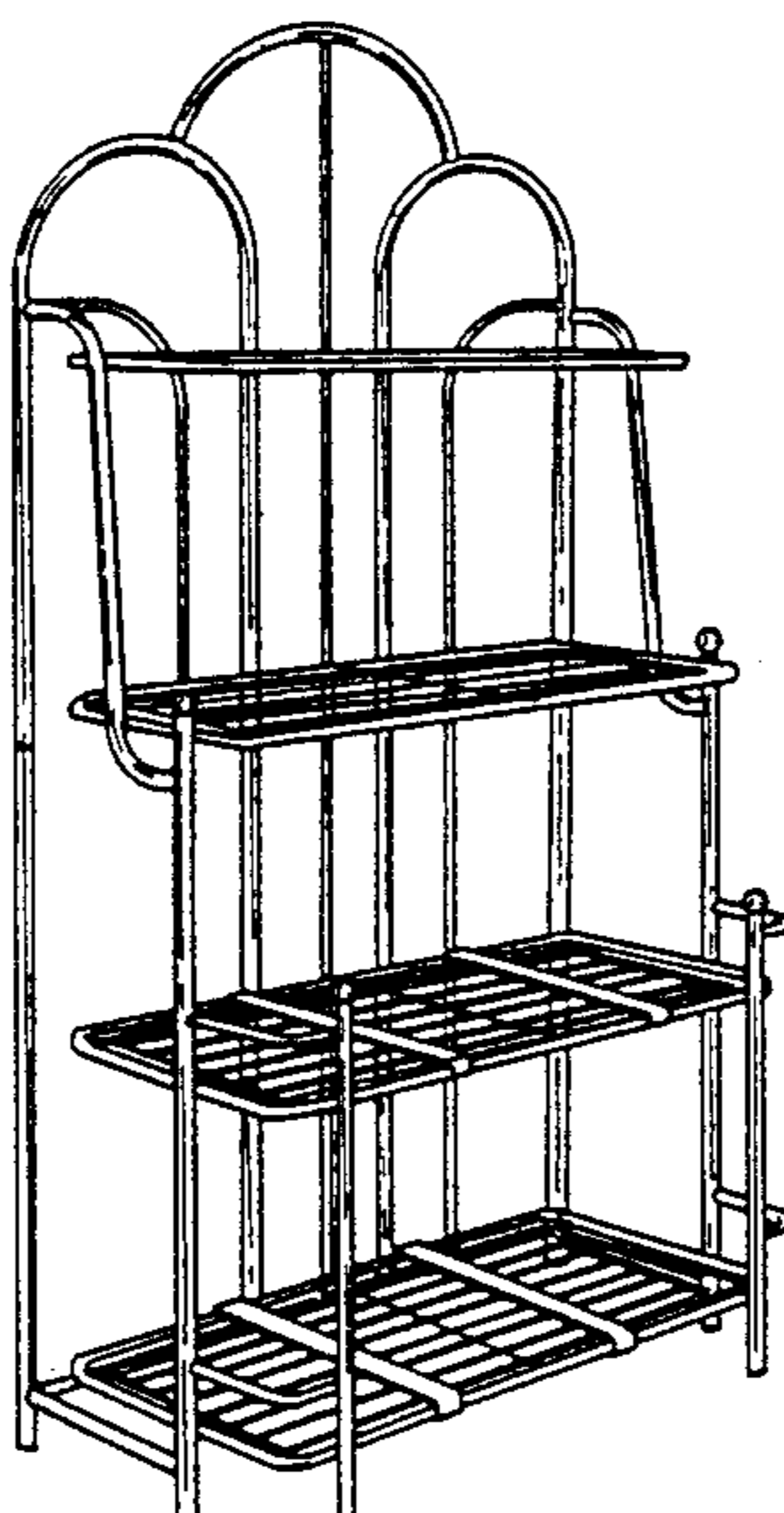

FIG.3

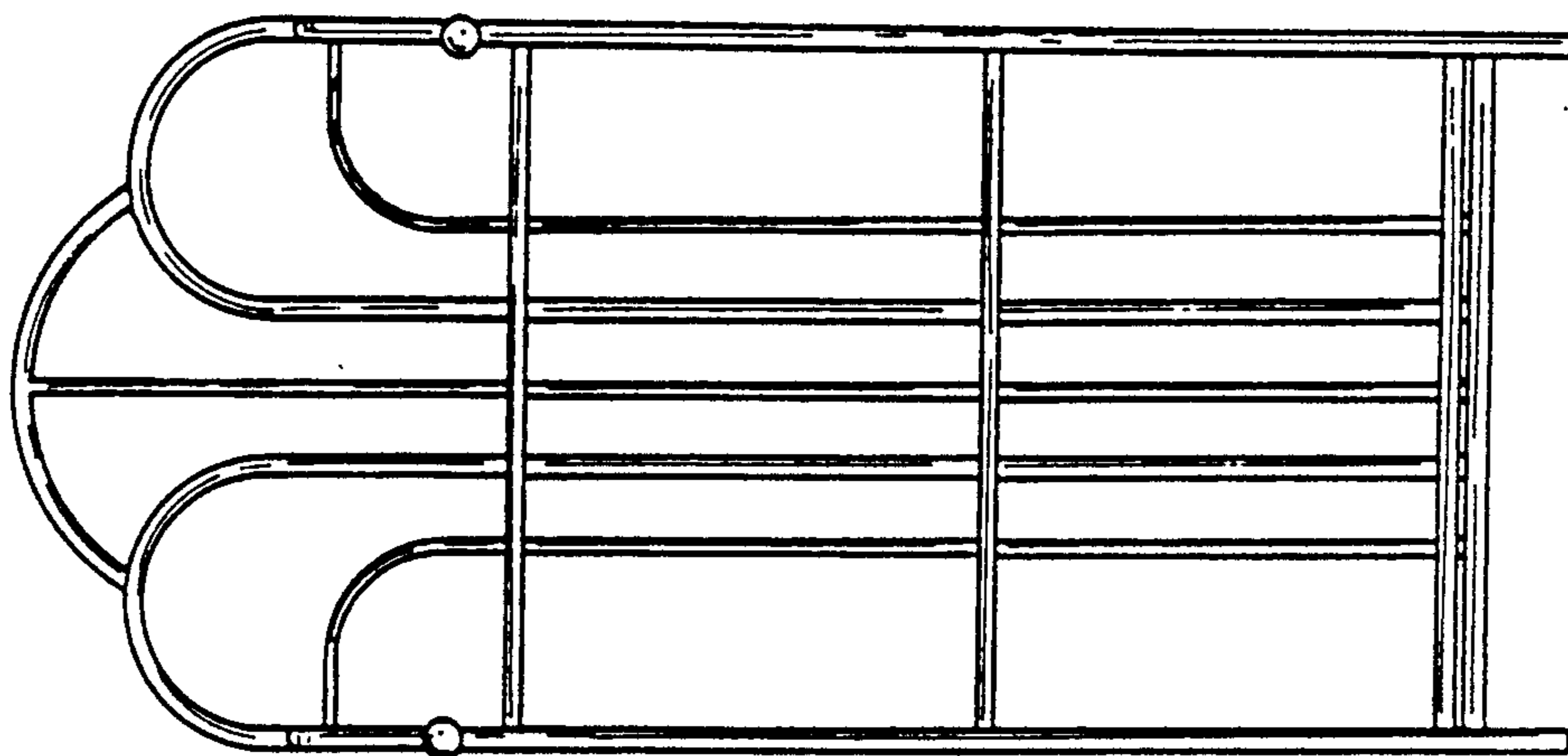

FIG.2

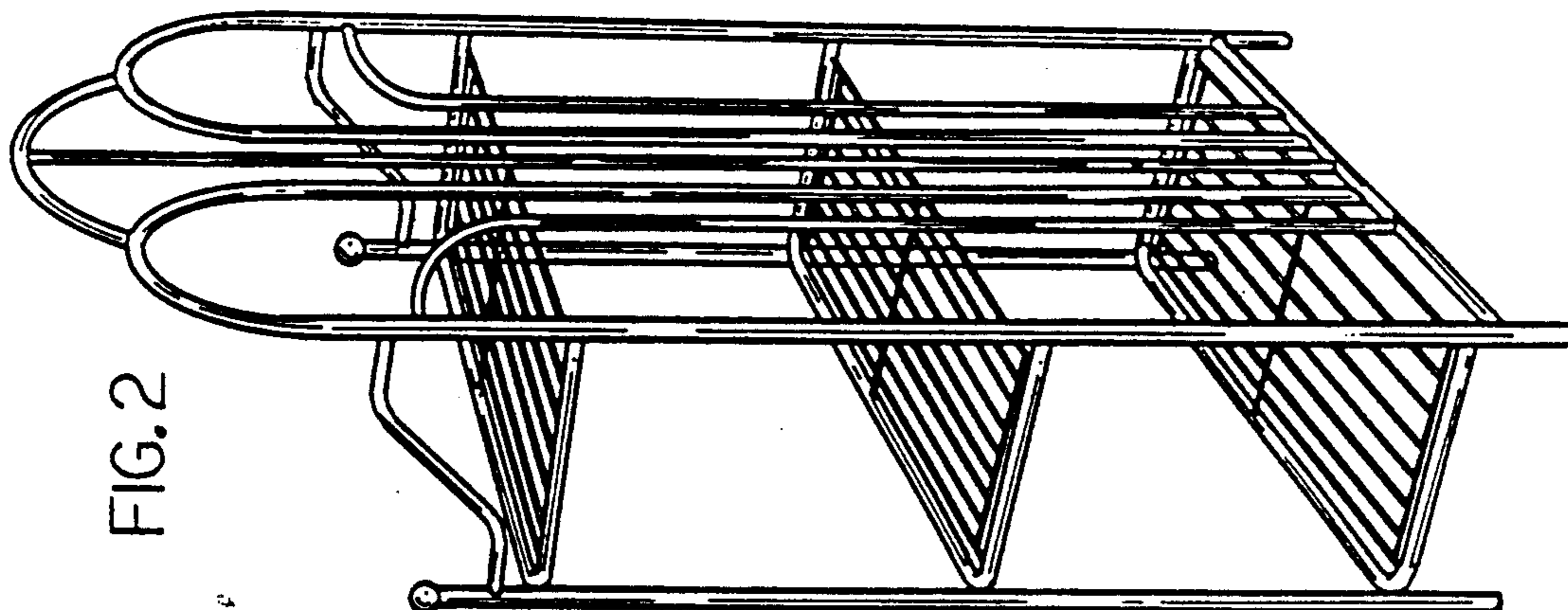
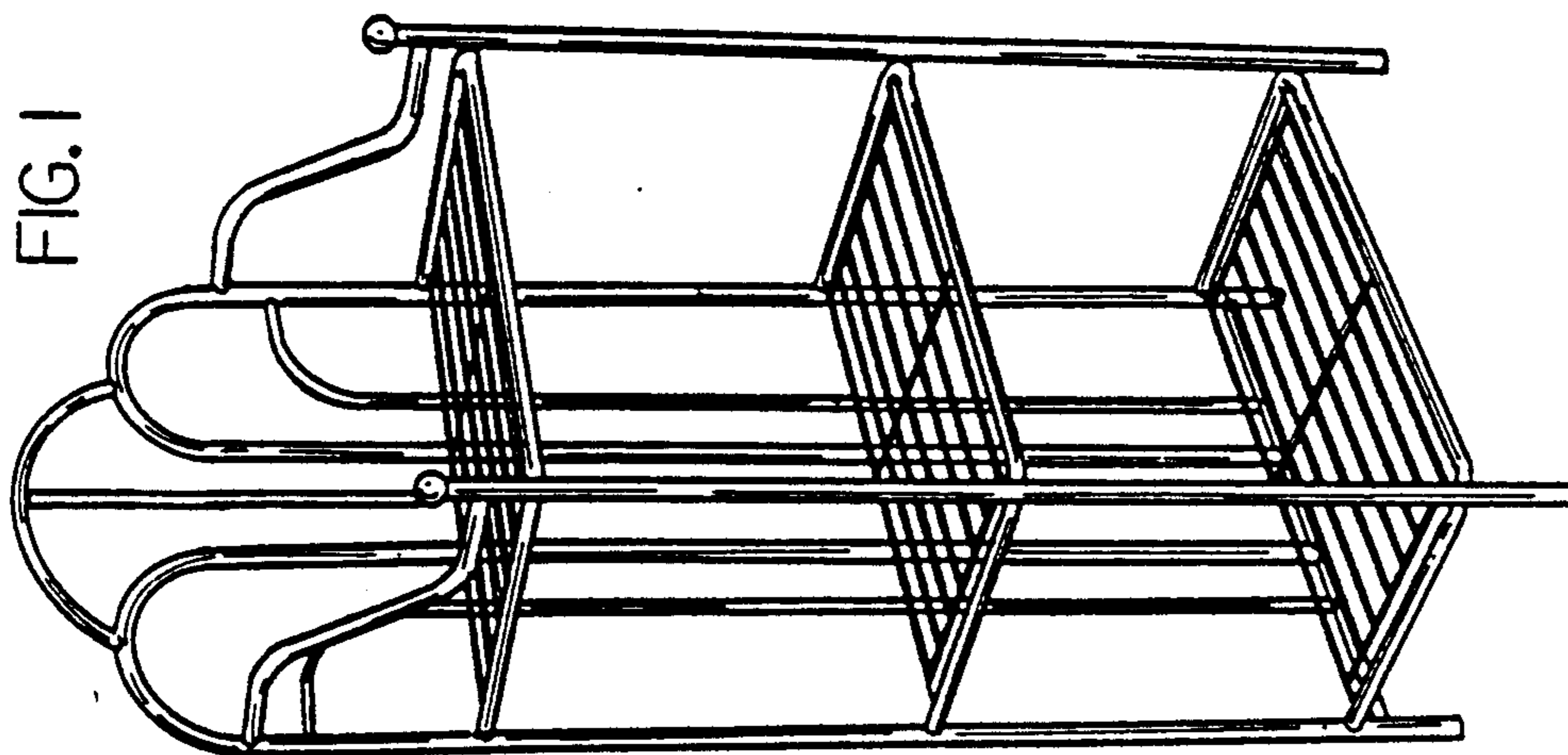

FIG.1



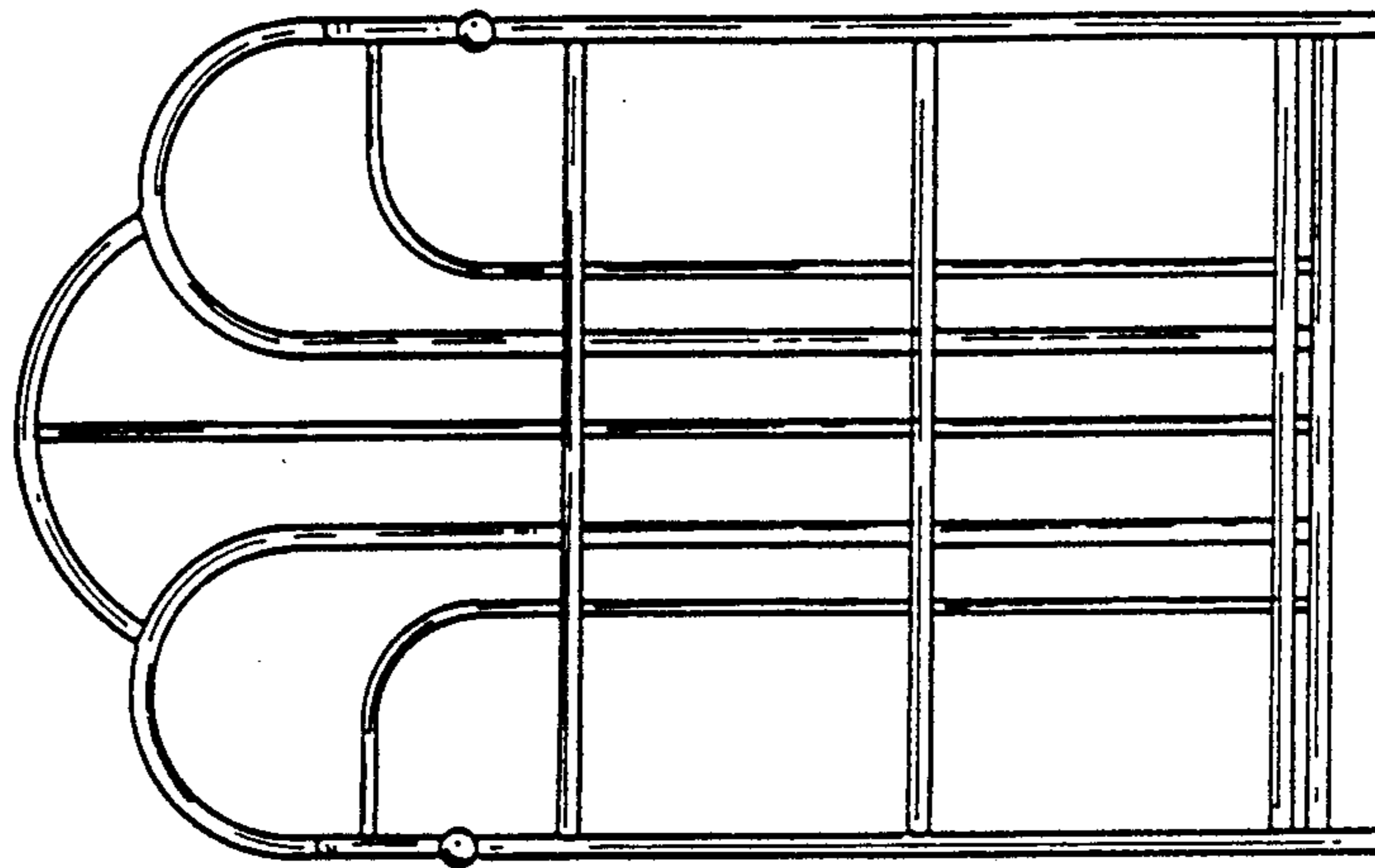

FIG. 6

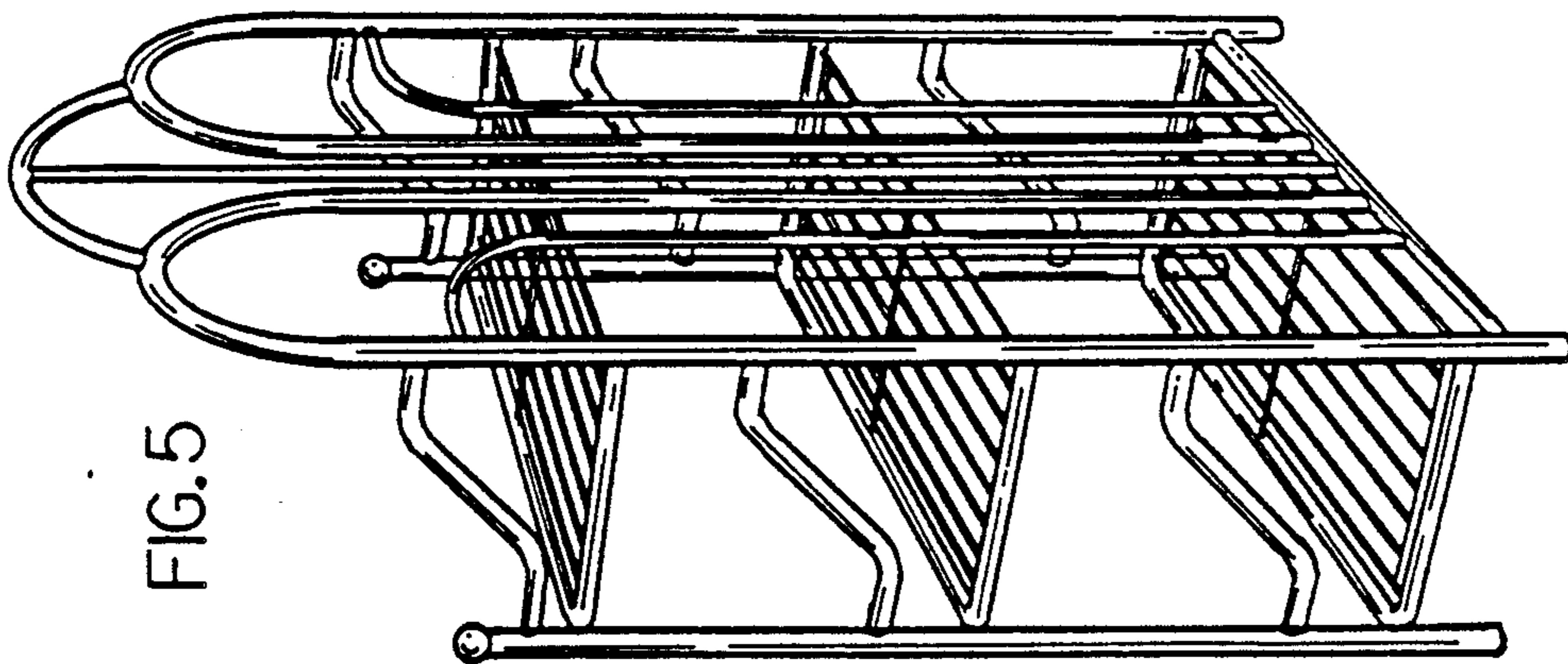

FIG. 5

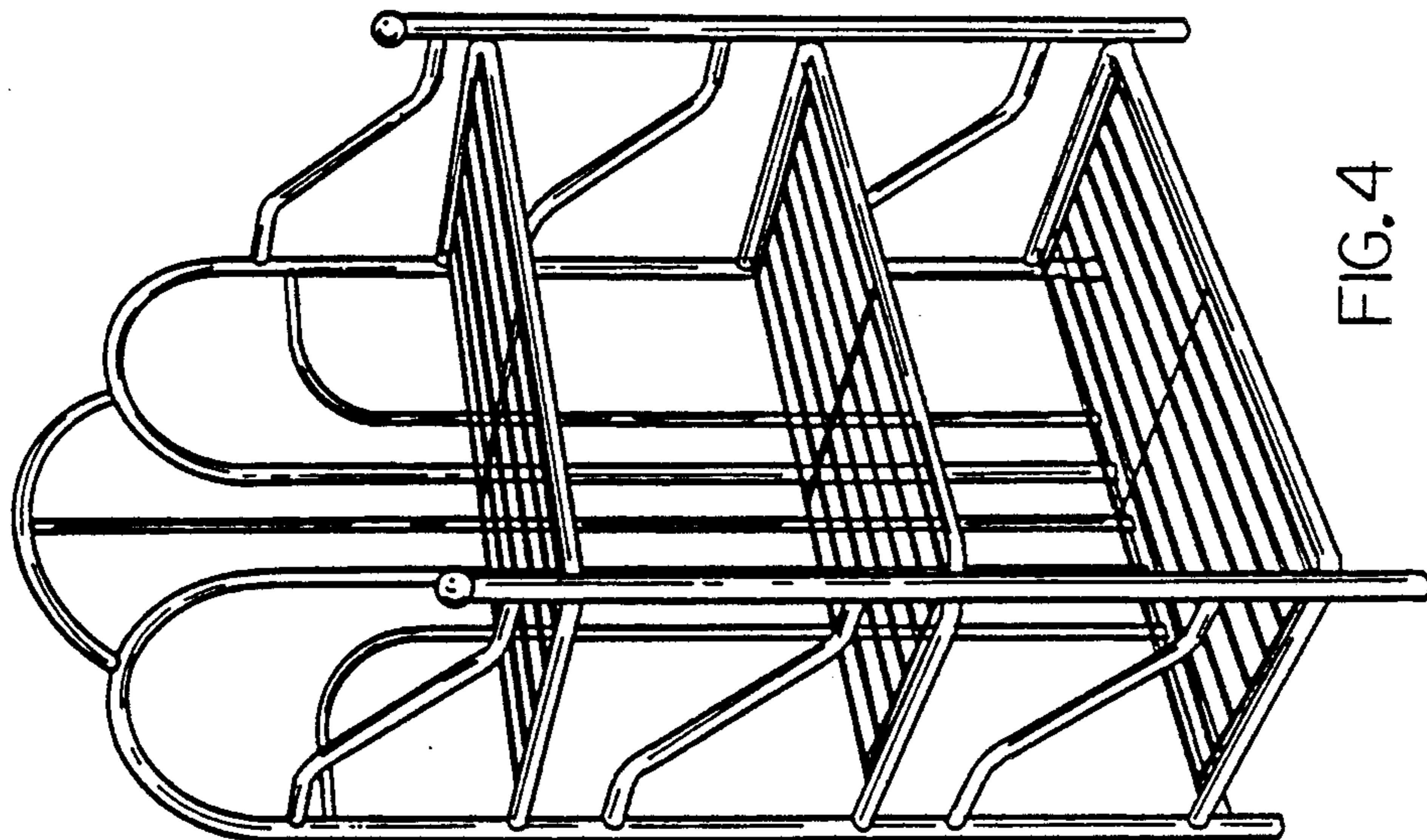

FIG. 4

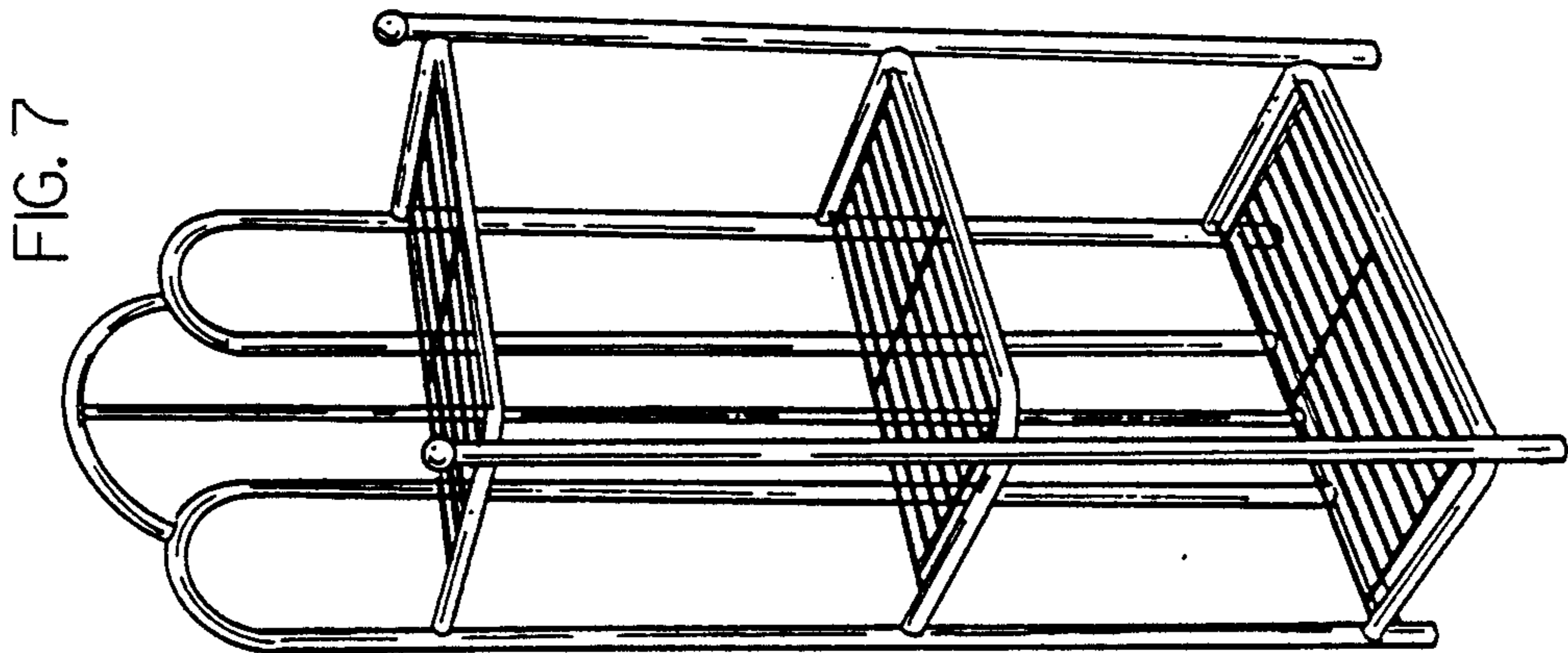
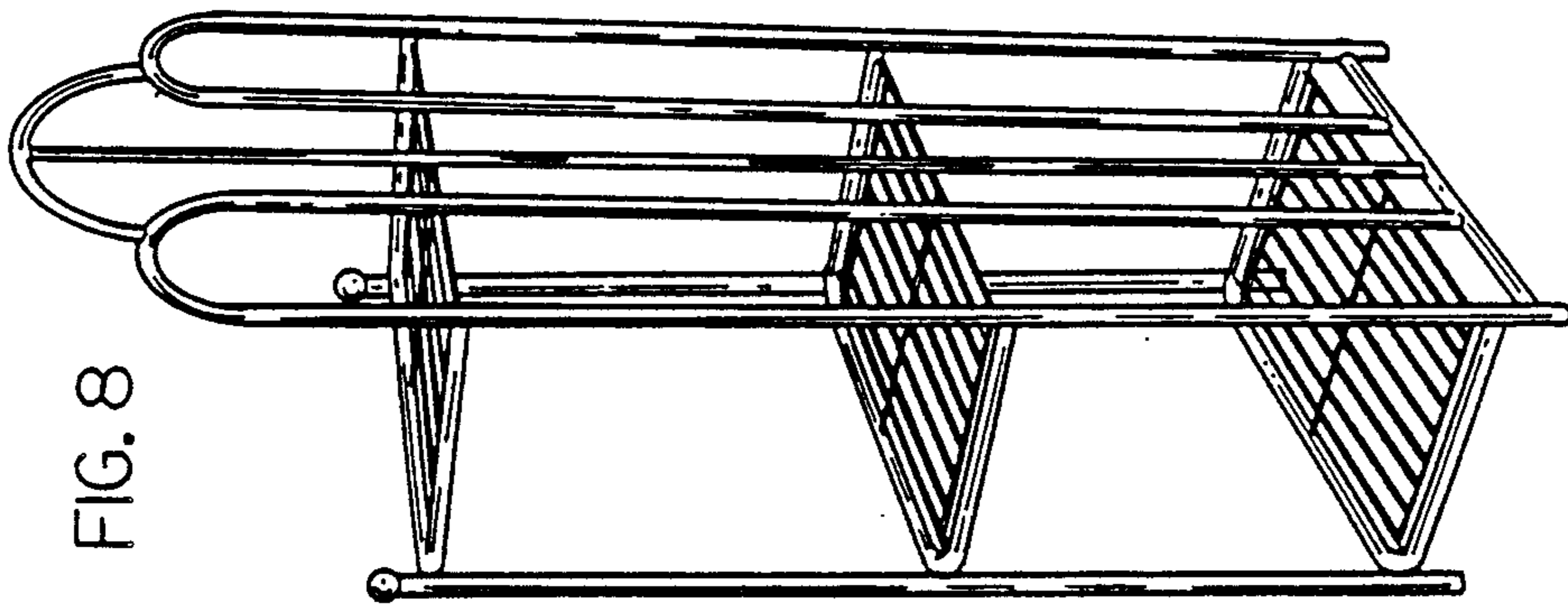
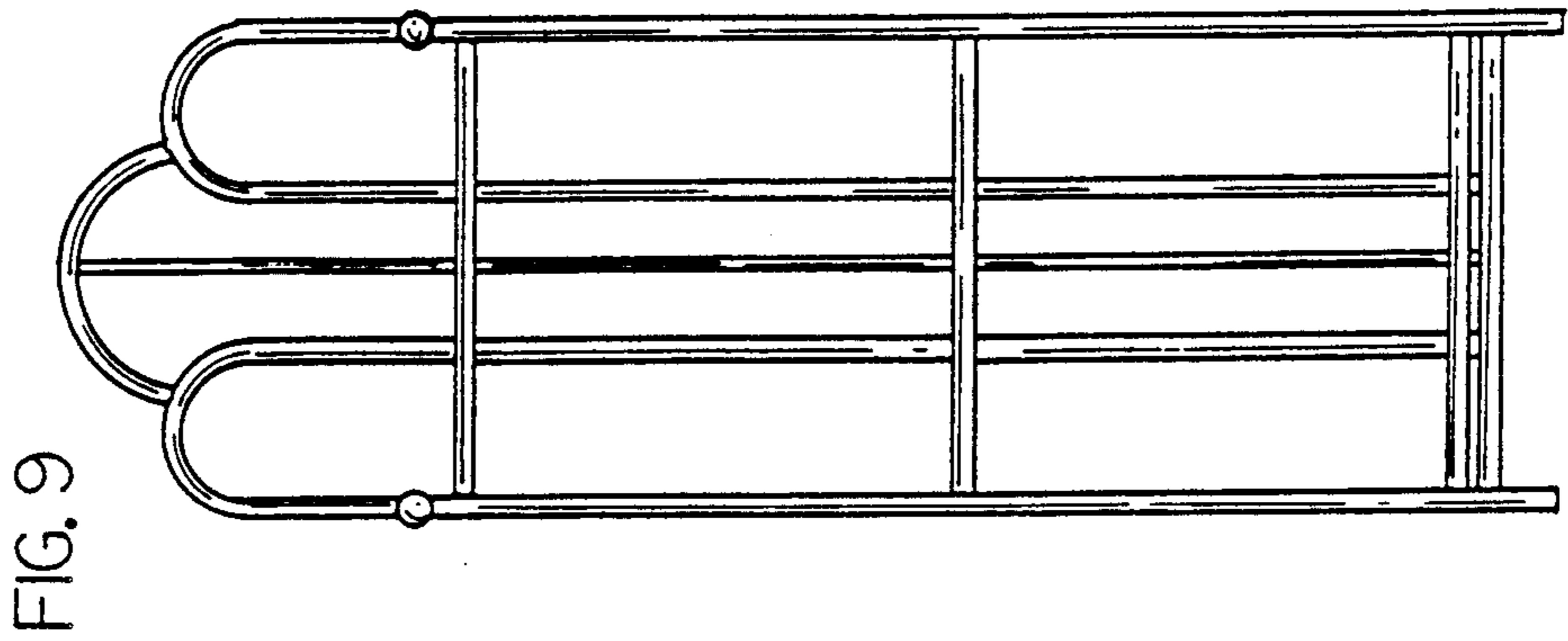

FIG. 12

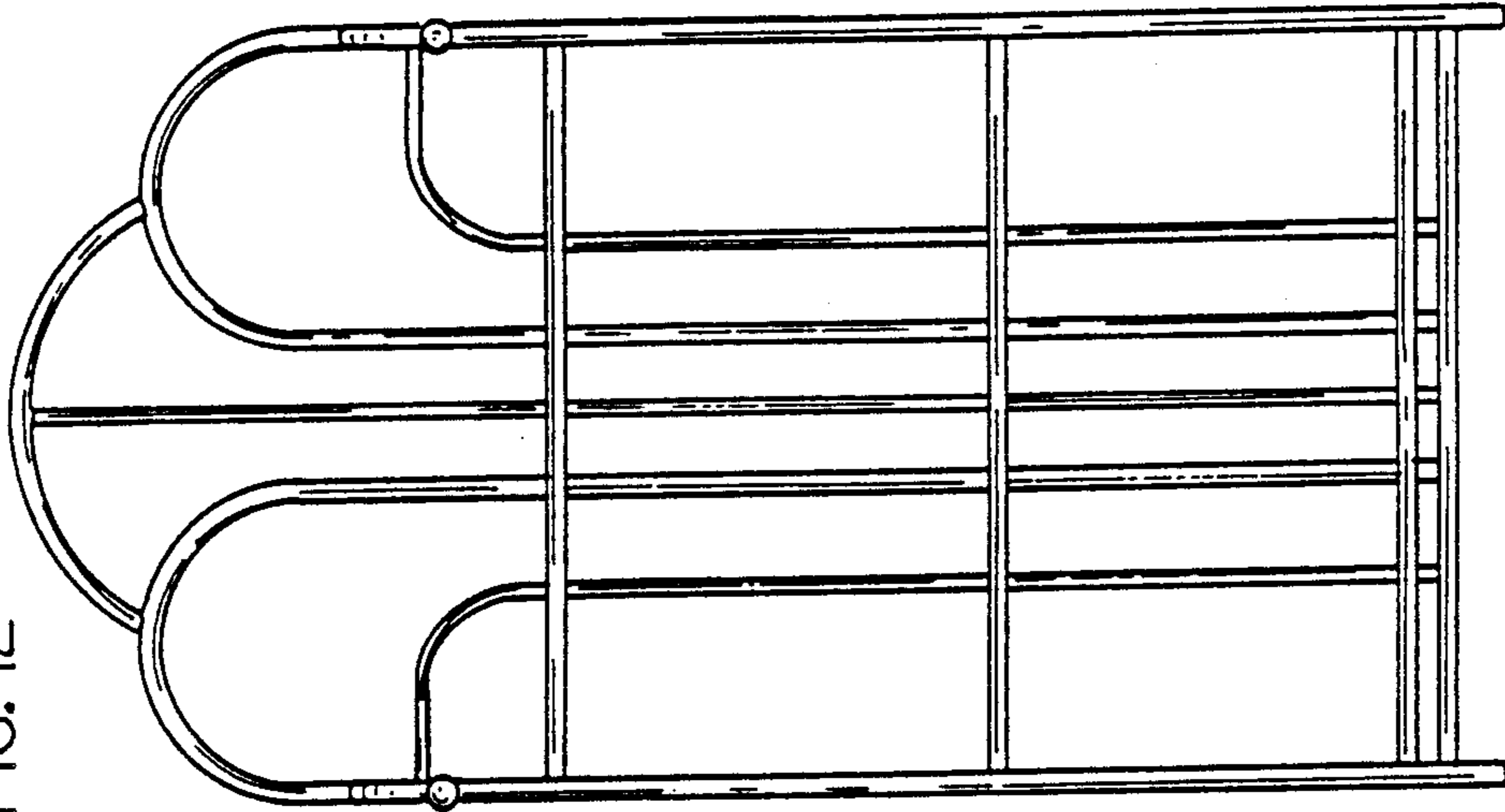

FIG. 11

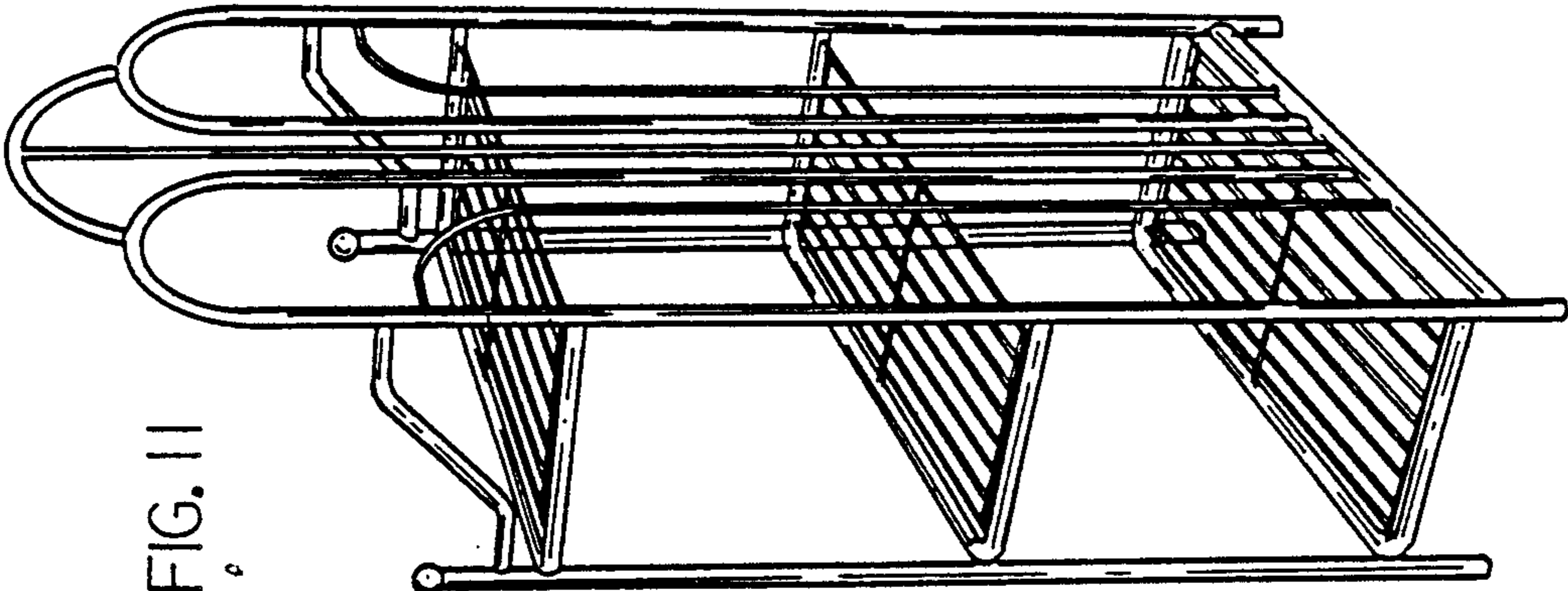
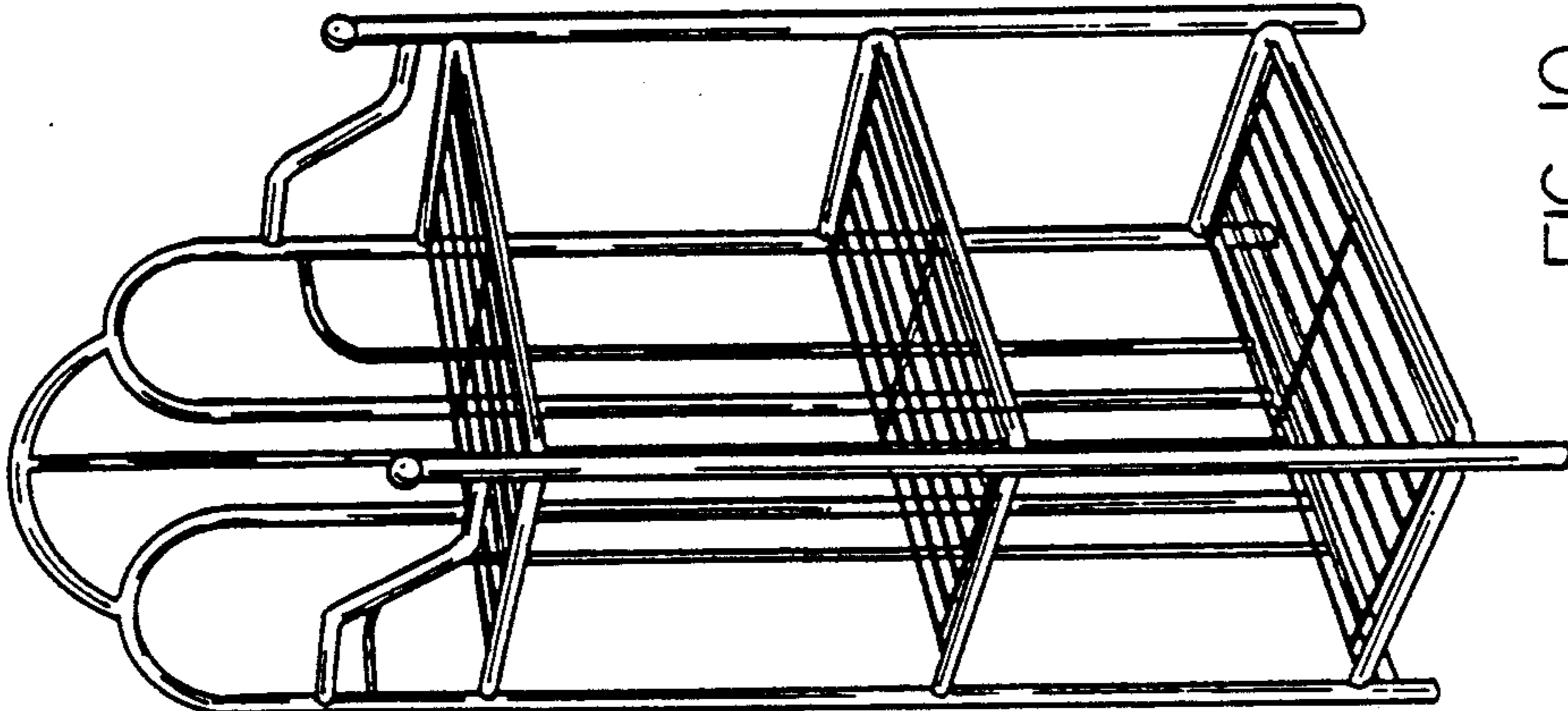

FIG. 10



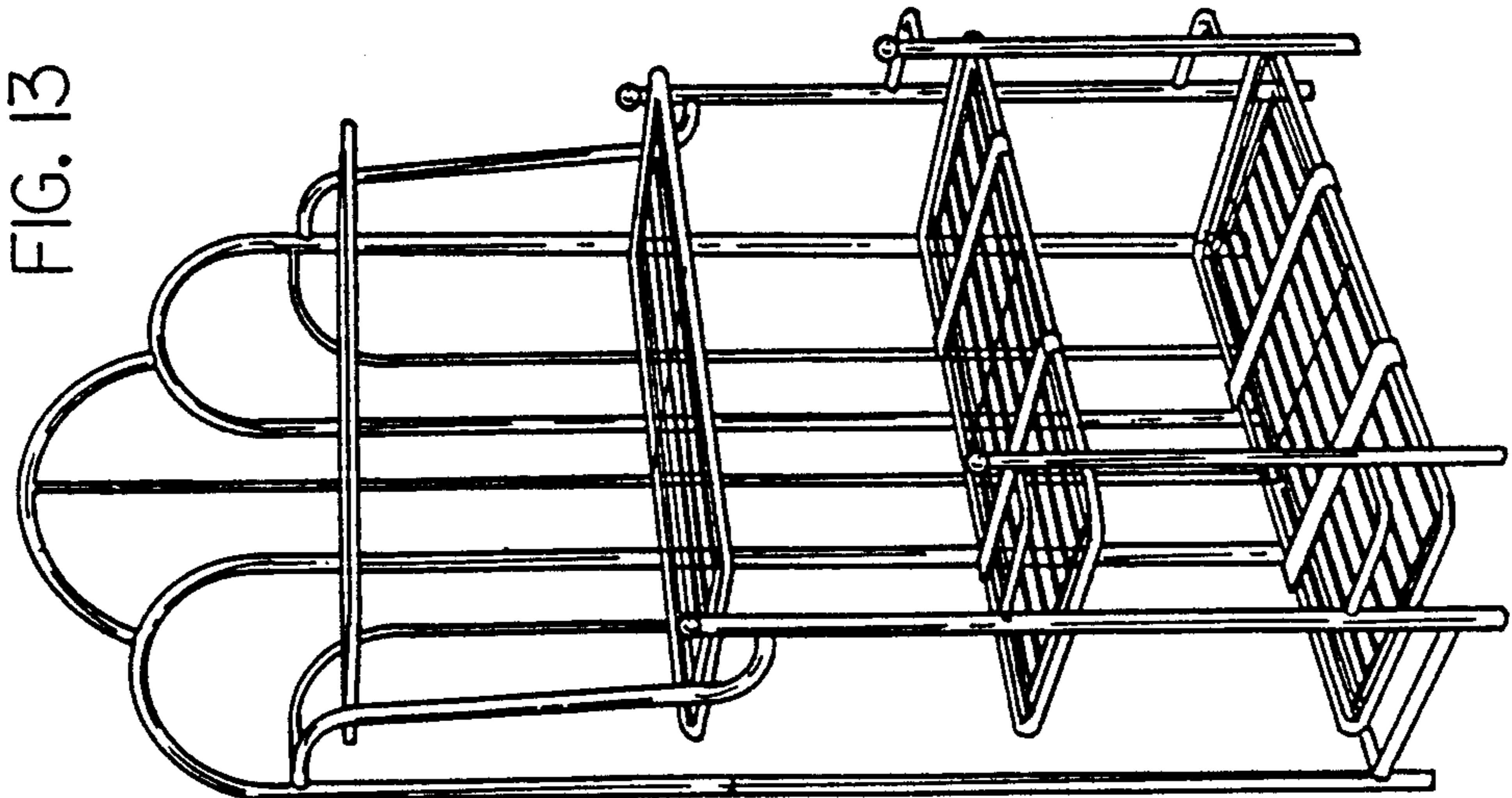
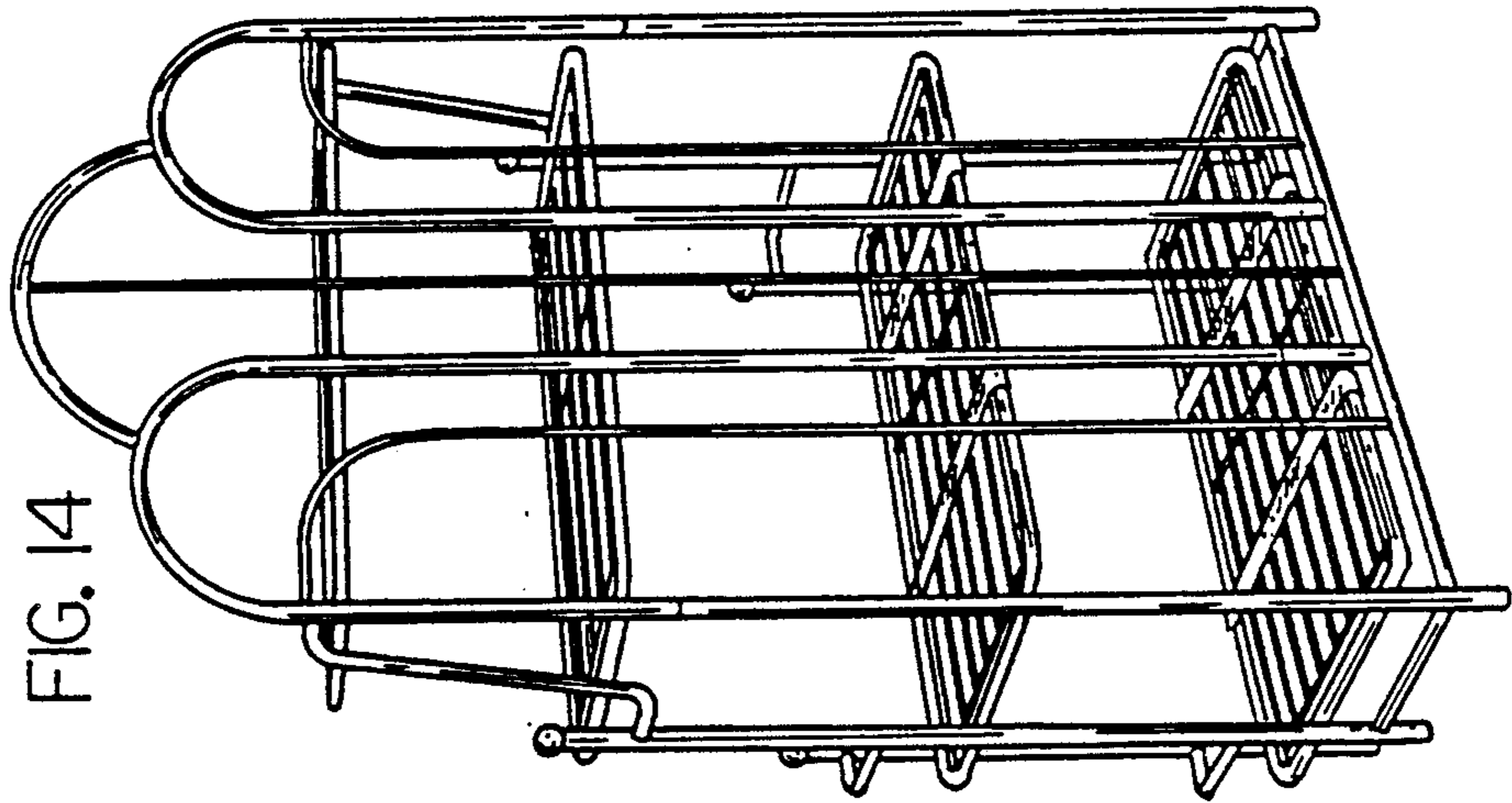
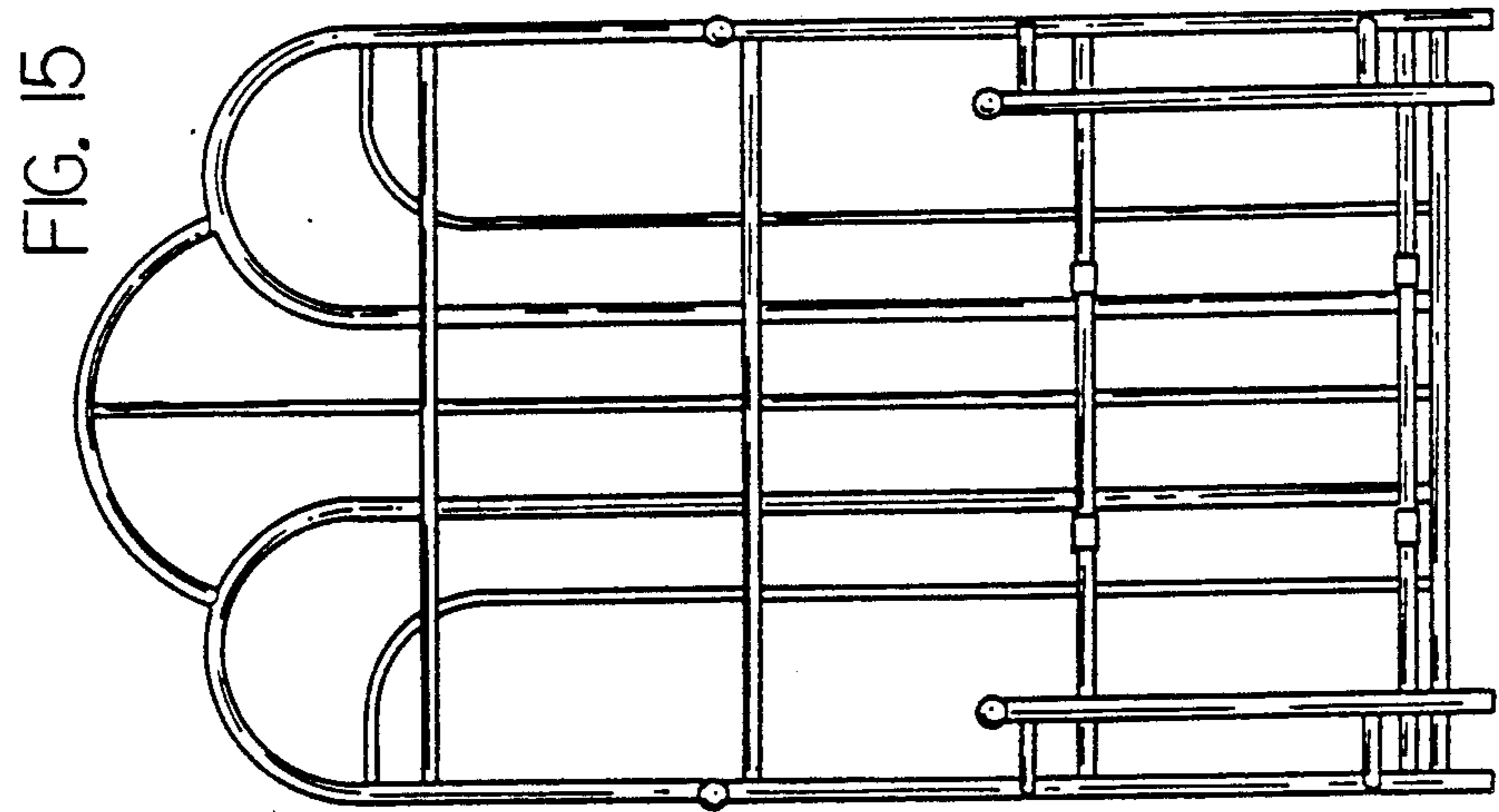

FIG. 18

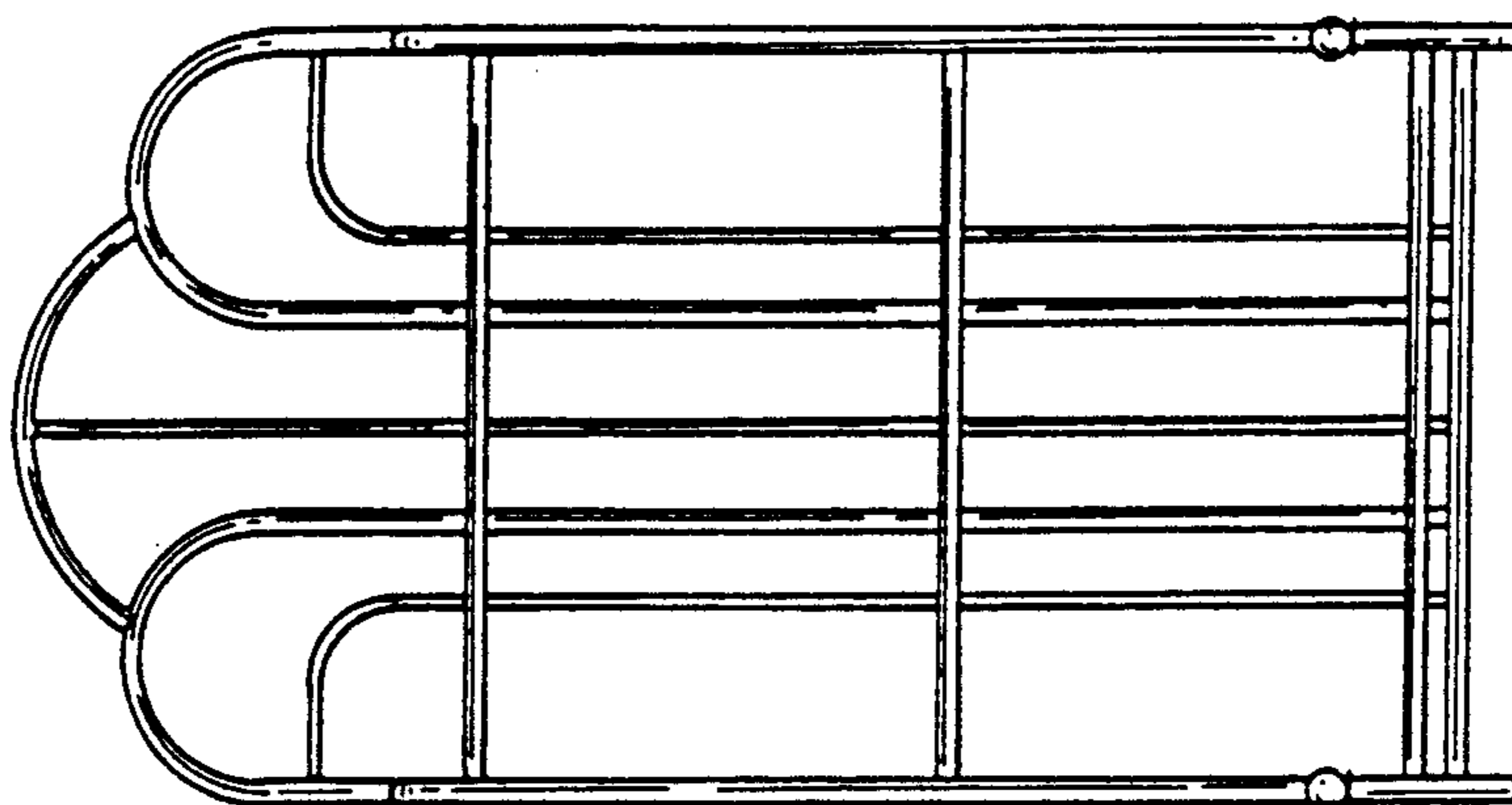

FIG. 17

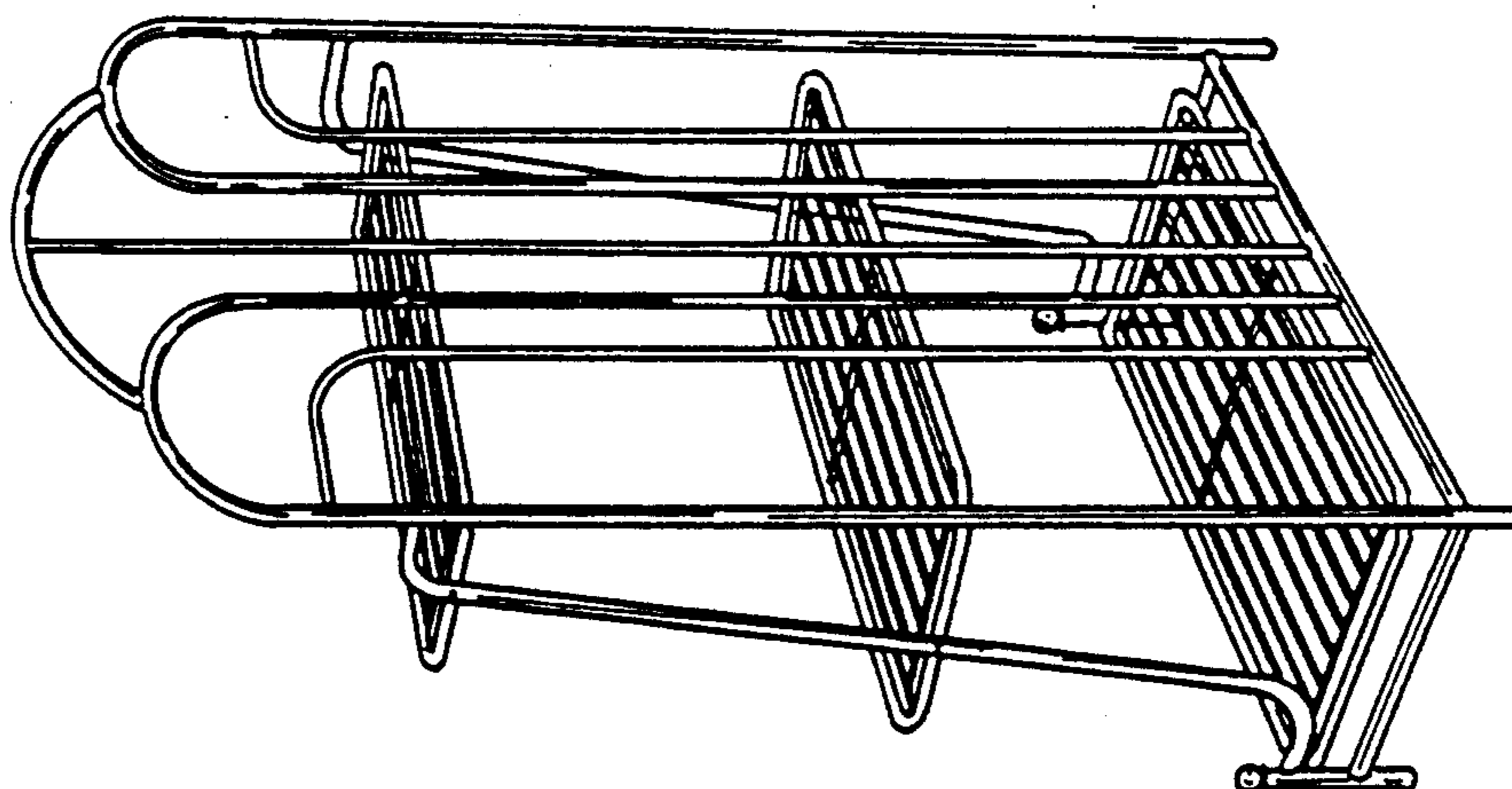
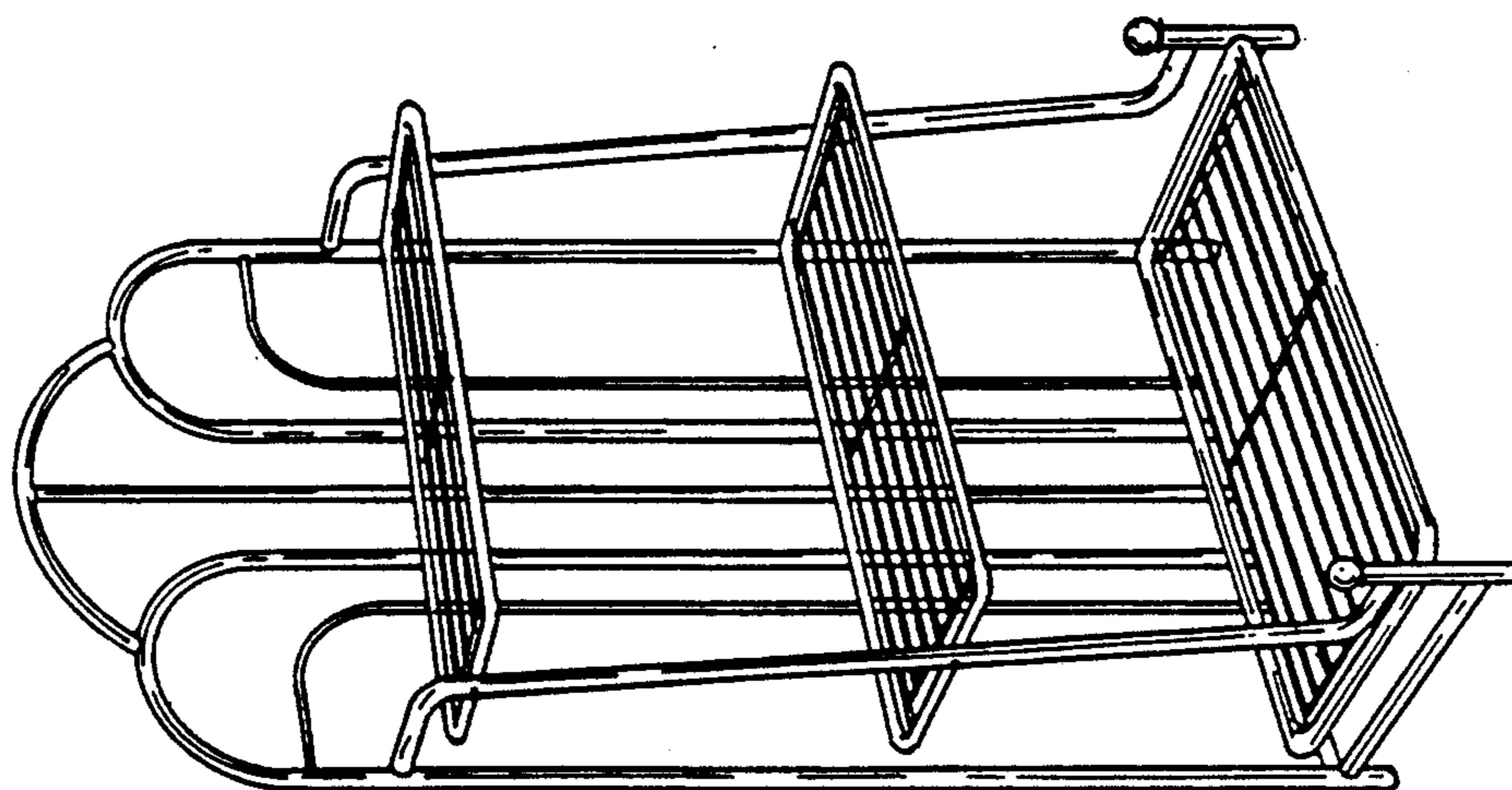

FIG. 16



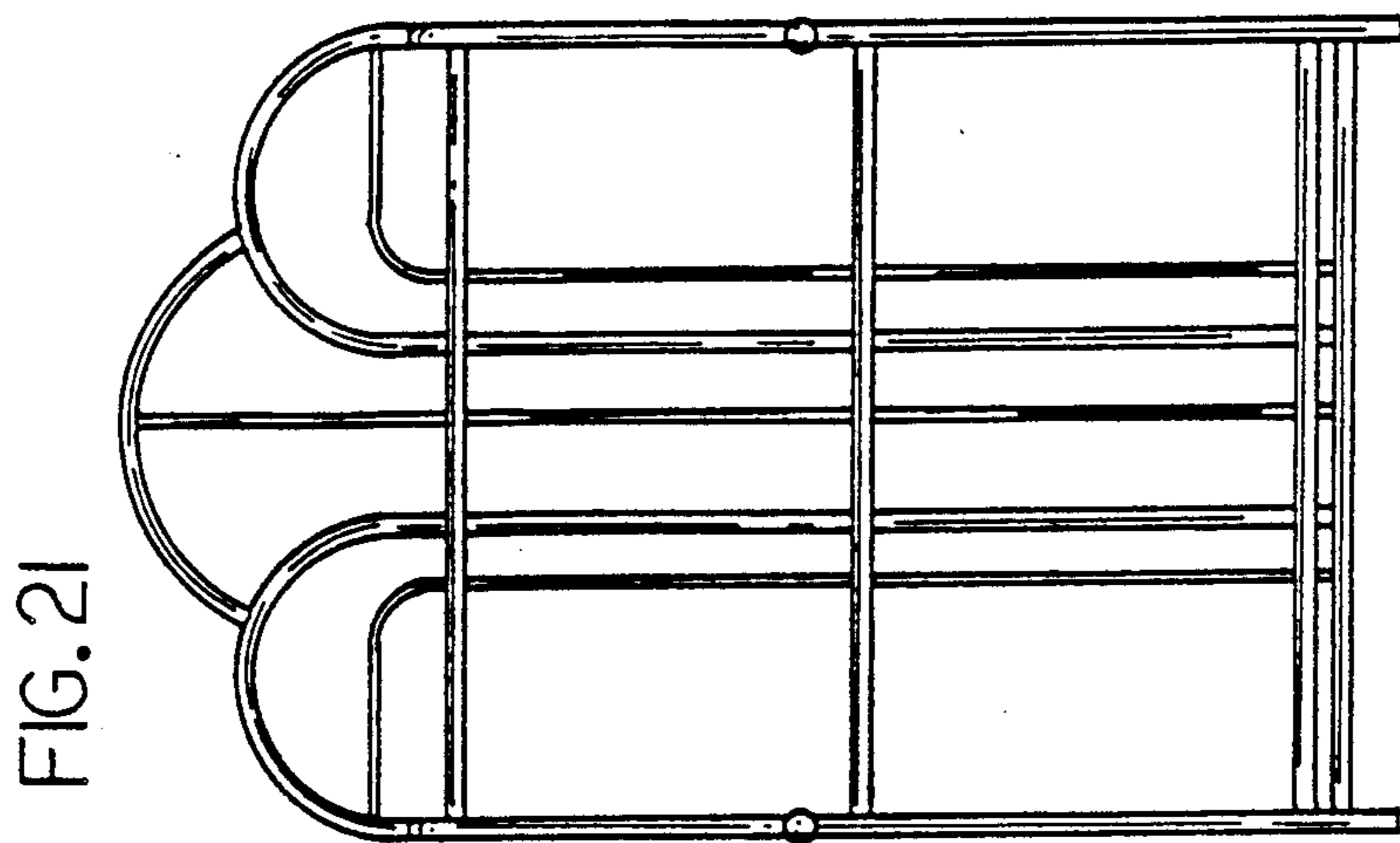

FIG. 21

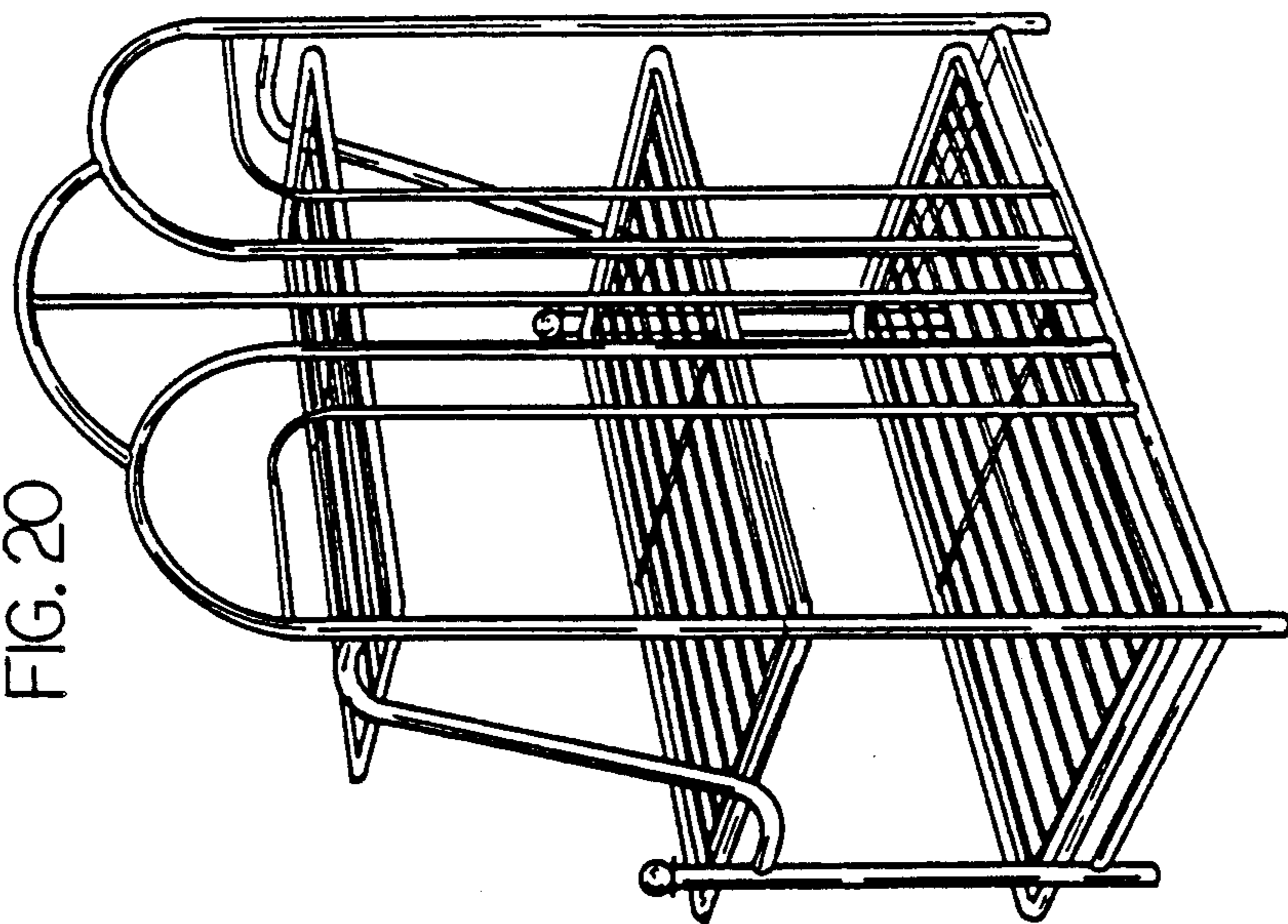

FIG. 20

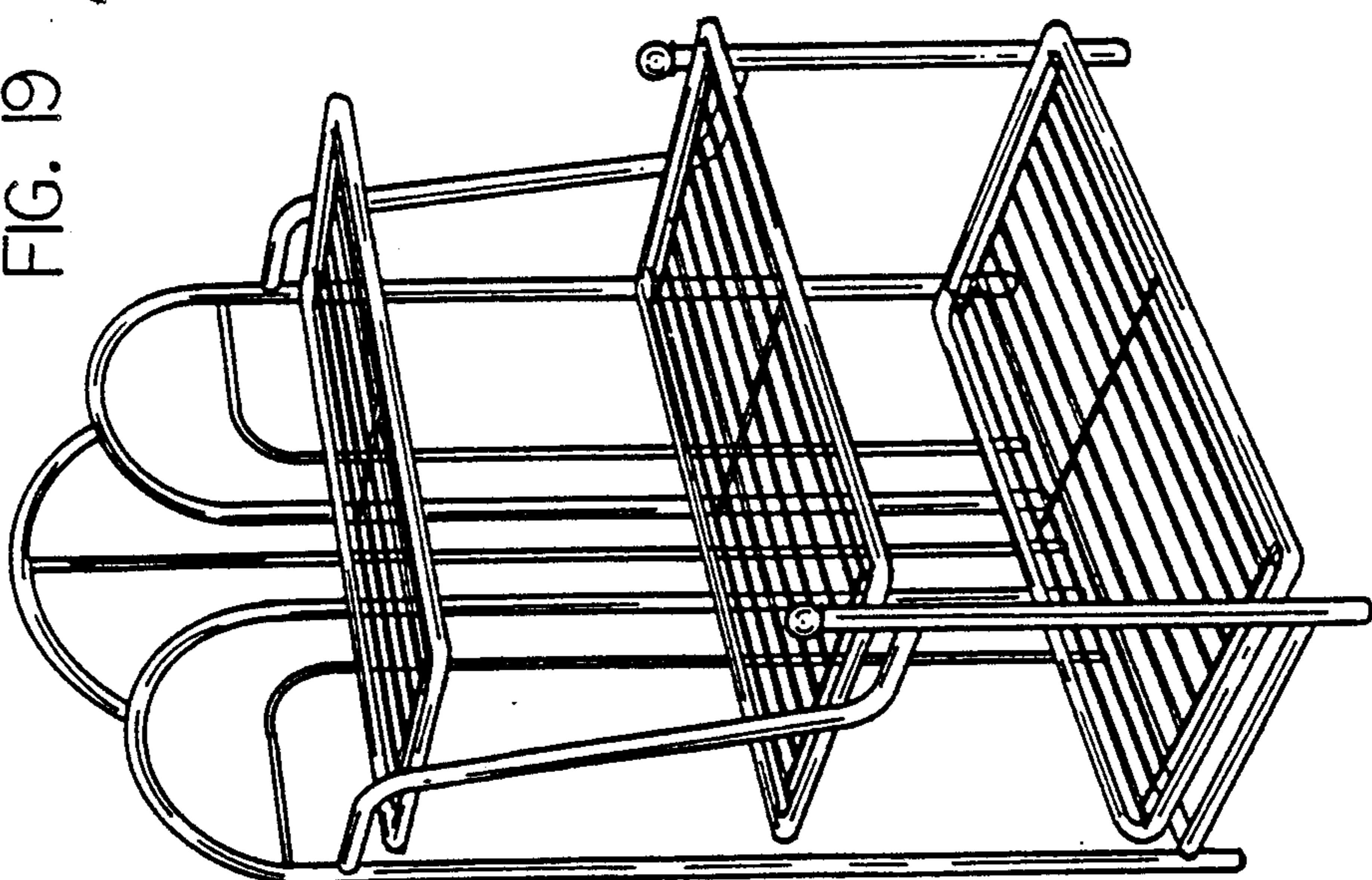

FIG. 19



FIG. 24

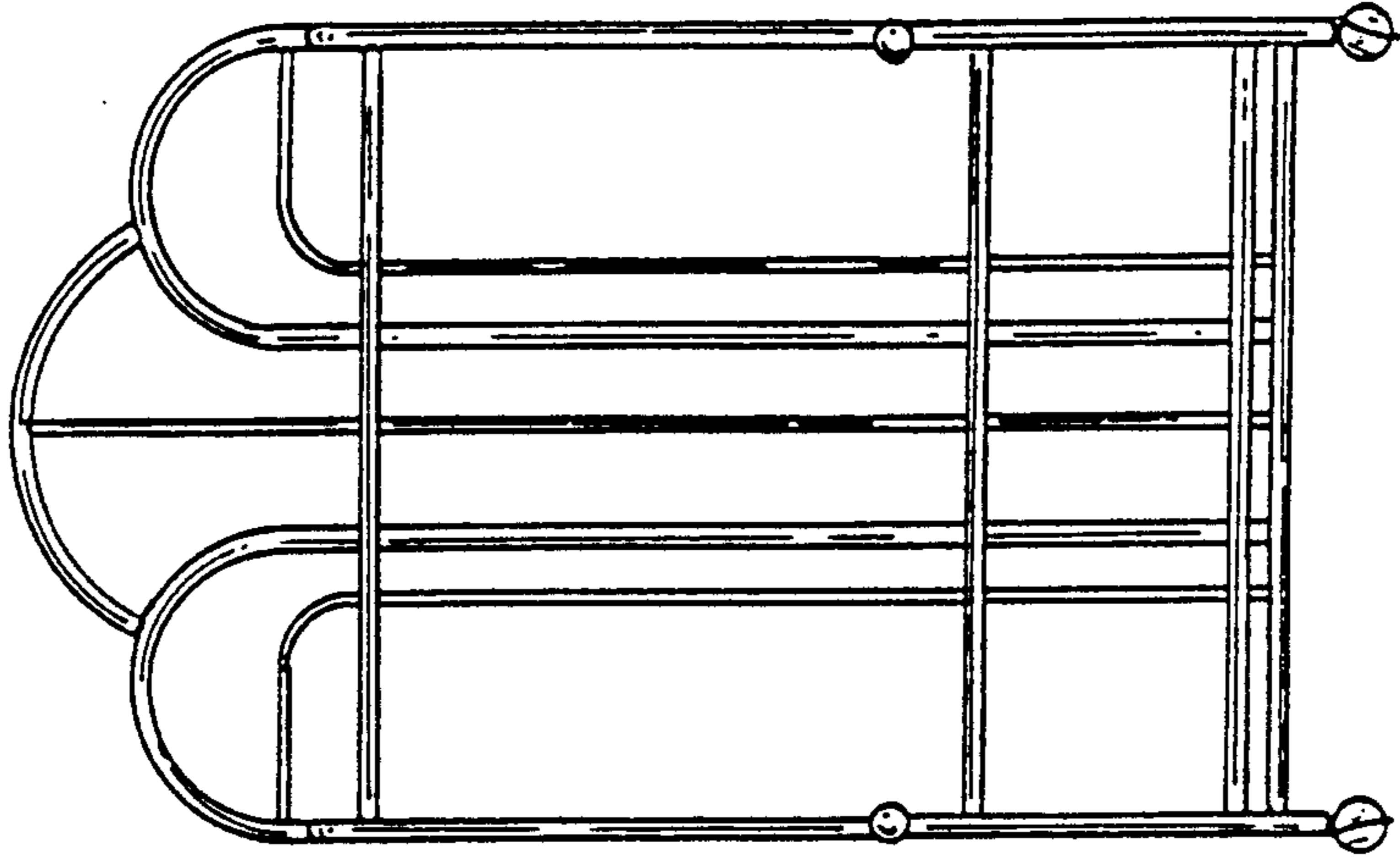

FIG. 23

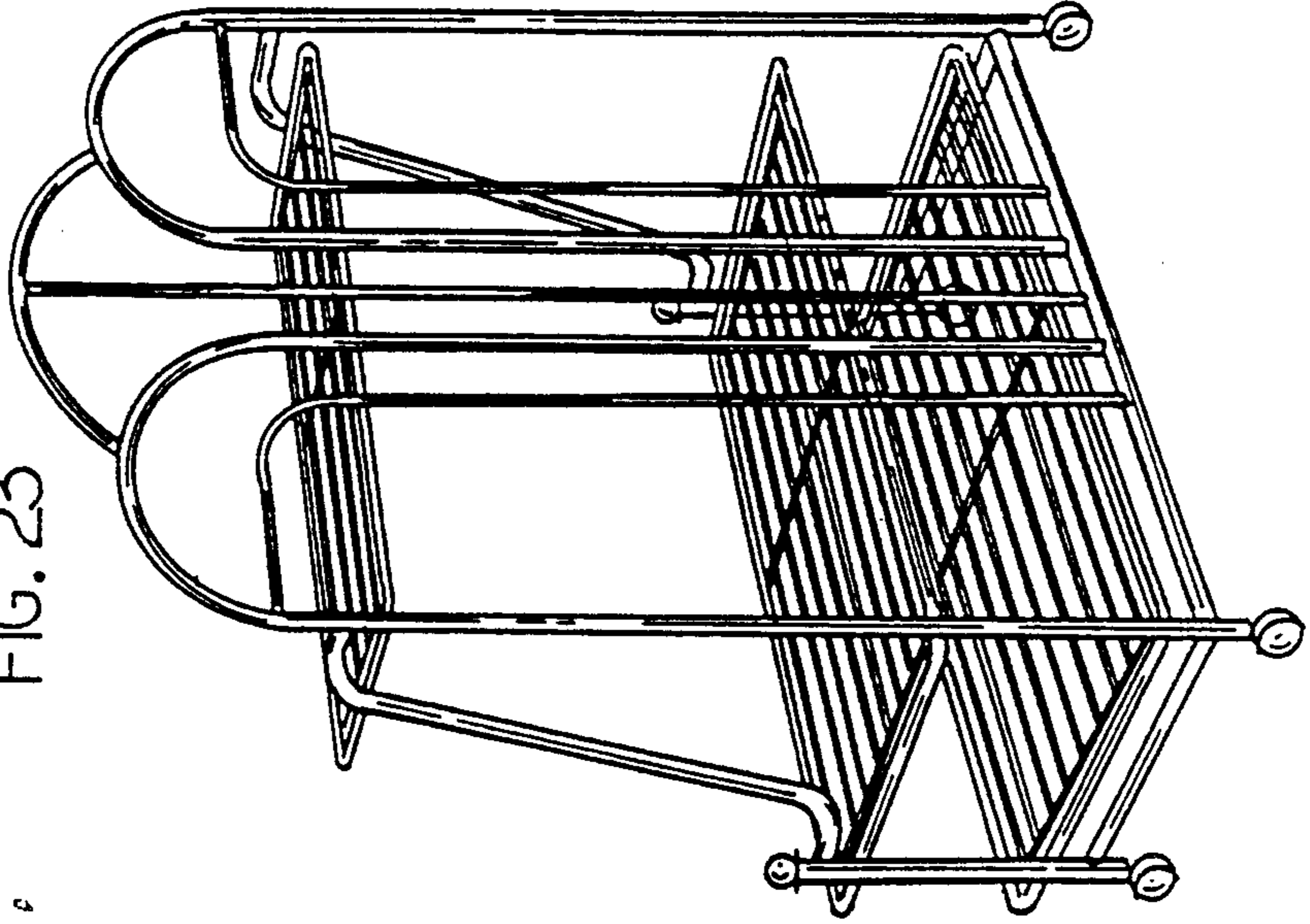

FIG. 22

