

[54] FURNITURE SUPPORT UNIT

[75] Inventor: Peter M. Yau Kee, Happy Valley, Hong Kong

[73] Assignee: Rosalco, Inc., Louisville, Ky.

[*] Notice: The portion of the term of this patent subsequent to Aug. 14, 2004 has been disclaimed.

[**] Term: 14 Years

[21] Appl. No.: 471,359

[22] Filed: Jan. 26, 1990

Related U.S. Application Data

[62] Division of Ser. No. 371,028, Jun. 23, 1989.

[52] U.S. Cl. D6/465; D6/479; D34/12

[58] Field of Search D34/12, 14, 21; D6/462, D6/464, 465, 474, 477, 479; 211/182

[56] References Cited

U.S. PATENT DOCUMENTS

D. 45,694 4/1914 Rosenberger D6/465
D. 176,473 12/1955 Moxley D34/21
D. 292,658 11/1987 Kester D6/465
D. 301,790 6/1989 Ivano D34/21

OTHER PUBLICATIONS

W. Bell & Co. catalog 1987, p. 151, item No. 3.
Furniture/Today, 7/11/1988 & 4/18/88, powell advertisement.
Progressive Architecture, 1/1983, p. 179.

Abitare, 9/1981, p. 137, #9 & #10.

Primary Examiner—Bruce W. Dunkins

Assistant Examiner—Jeffrey Asch

Attorney, Agent, or Firm—Rhodes, Coats & Bennett

[57] CLAIM

The ornamental design for a furniture support unit, as shown and described.

DESCRIPTION

FIG. 1 is a front perspective view of a furniture support unit showing my new design in the form of a TV/VCR stand;

FIG. 2 is a rear perspective view of the stand of FIG. 1; FIG. 3 is a front elevational view of the stand of FIG. 1;

FIG. 4 is a side elevational view showing a second embodiment of the stand of FIG. 1;

FIG. 5 is a front elevational view showing a third embodiment of the stand of FIG. 1 in the form of a plant stand;

FIG. 6 is a rear perspective view of the stand of FIG. 5; FIG. 7 is a front elevational view of the stand of FIG. 5;

FIG. 8 is a side elevational view showing a fourth embodiment of the stand of FIG. 1;

FIG. 9 is a front perspective view of a fifth embodiment of the stand of FIG. 1 in the form of a book shelf unit; FIG. 10 is a rear perspective view of the shelf unit of FIG. 9;

FIG. 11 is a front elevational view of the shelf unit of FIG. 9; and

FIG. 12 is a side elevational view of a sixth embodiment of the stand of FIG. 1.

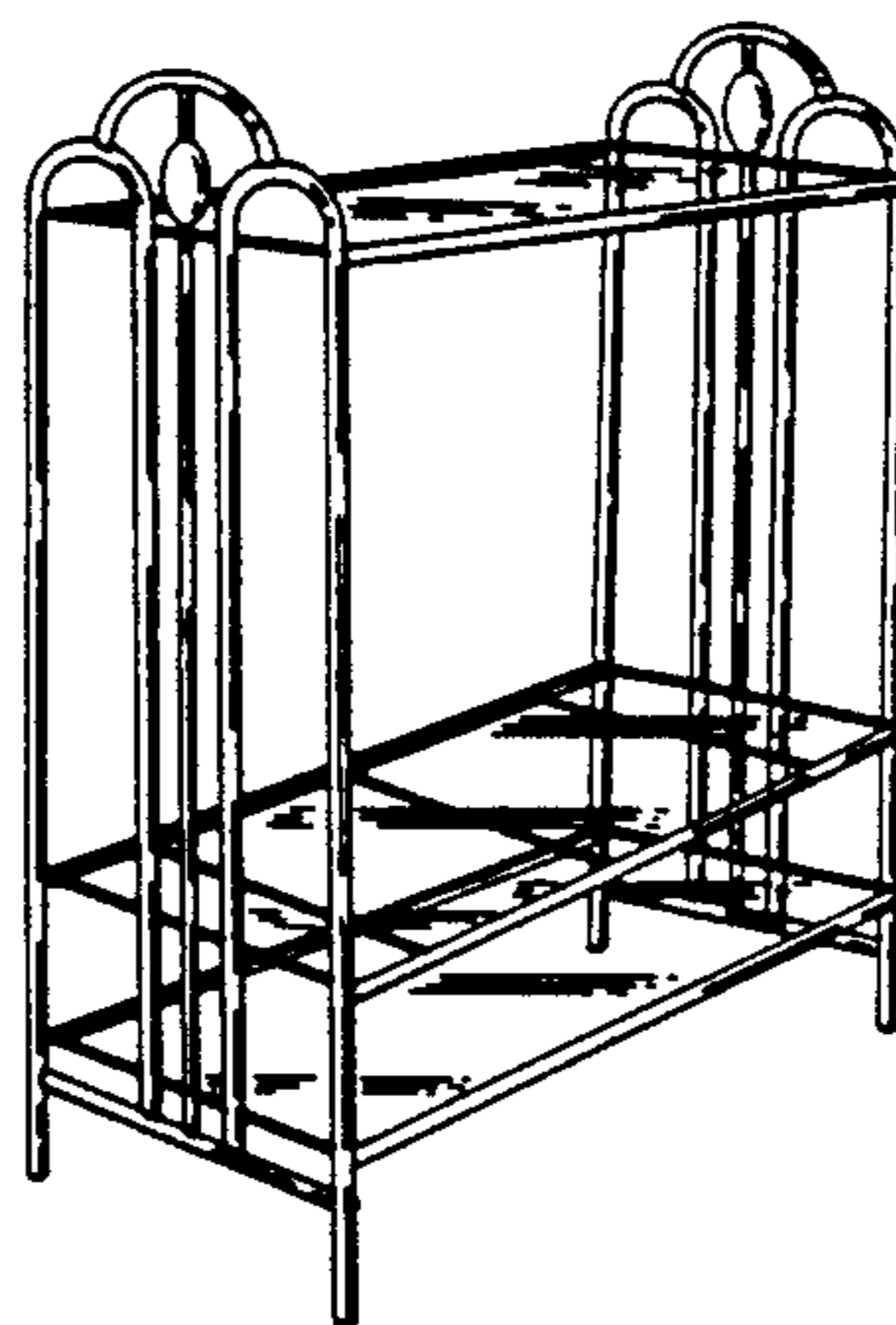
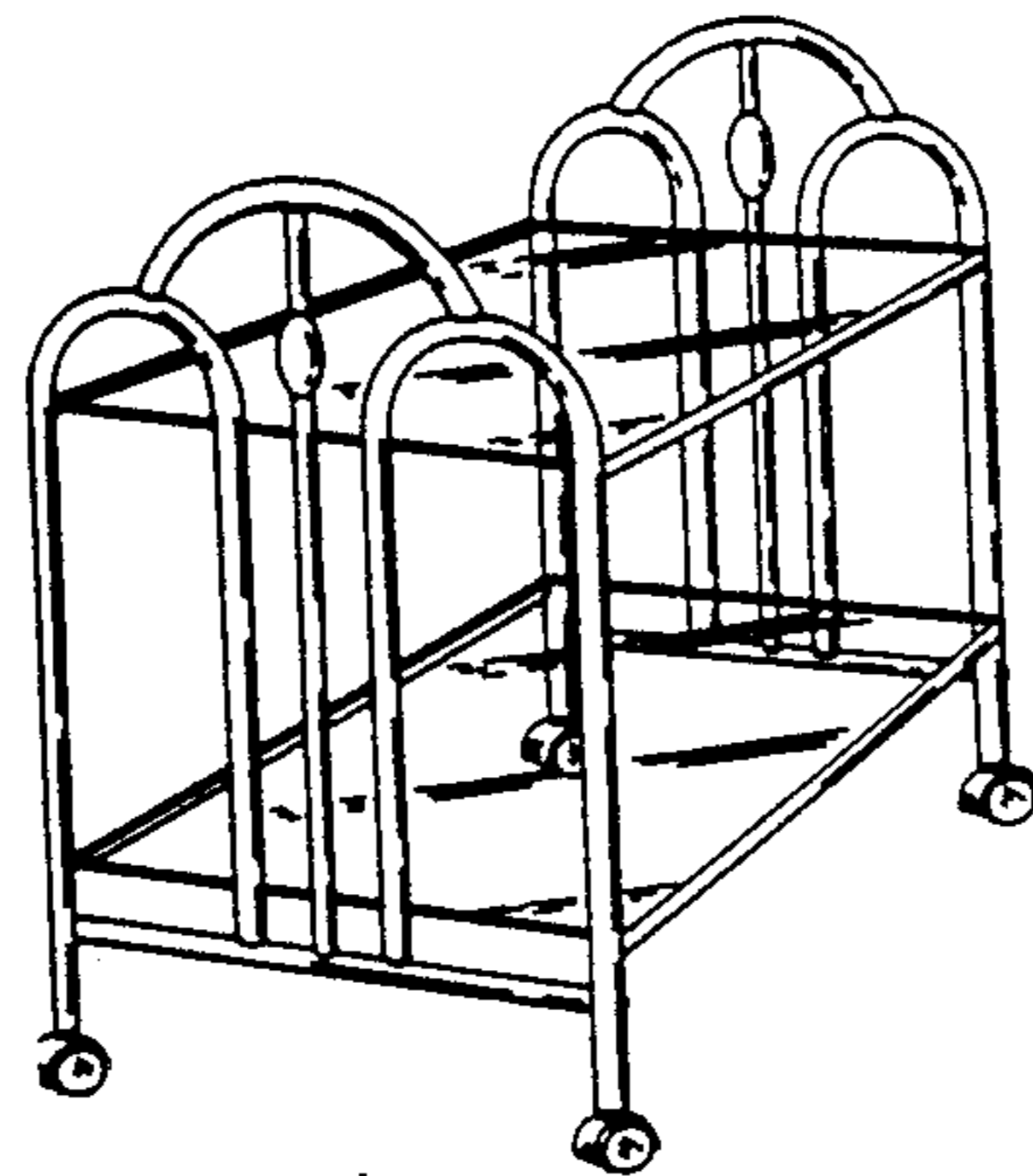

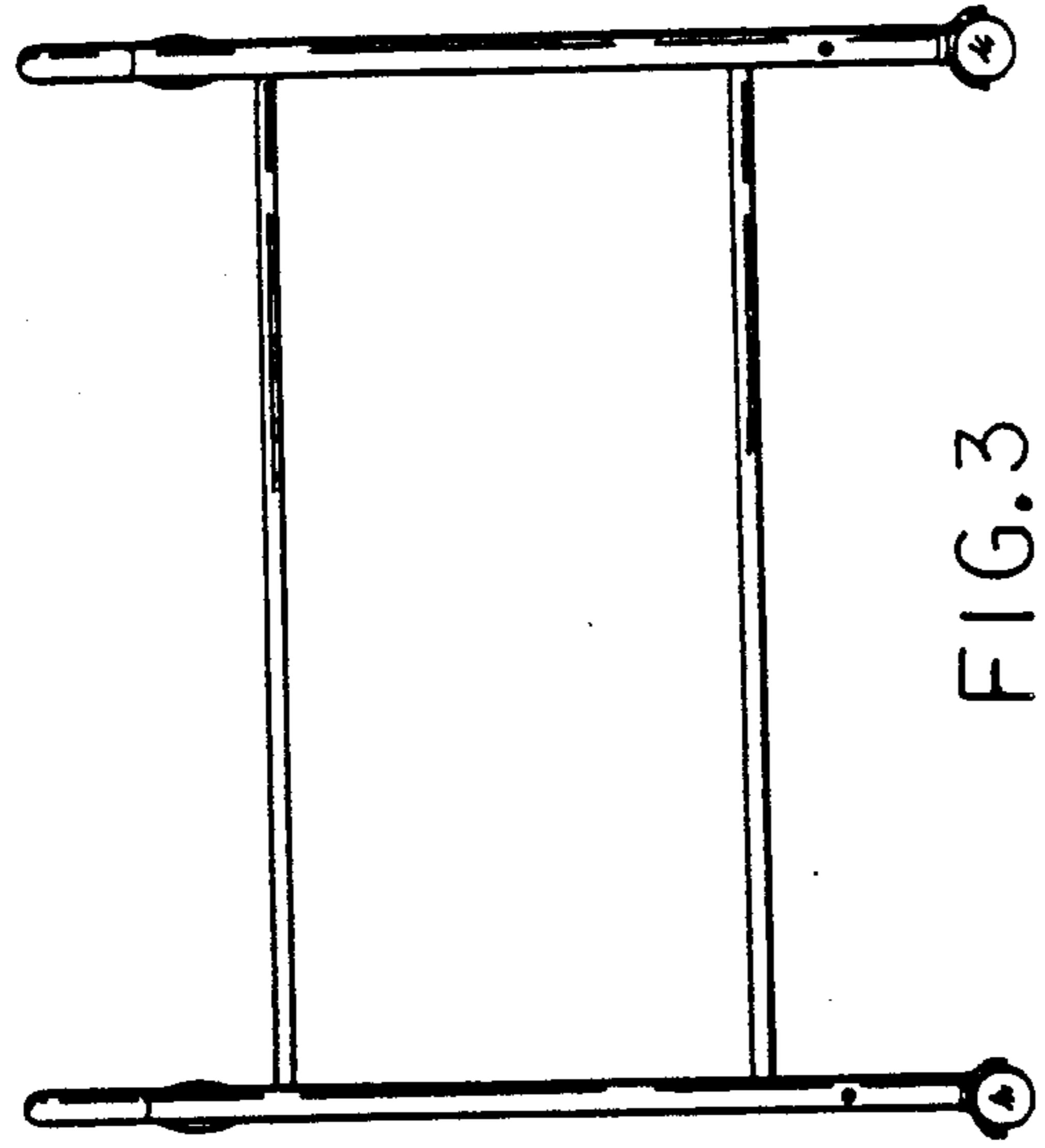

FIG. 3

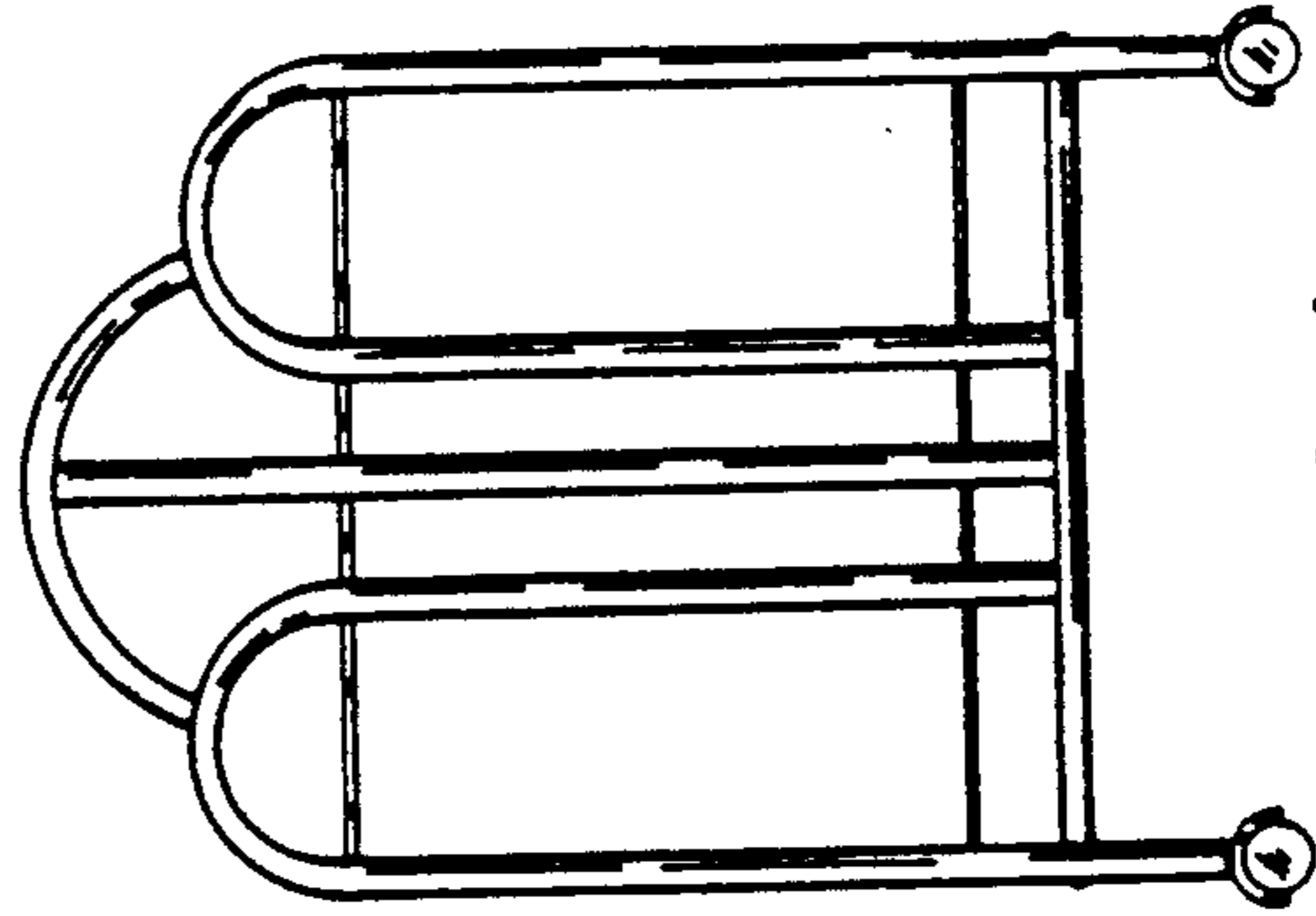

FIG. 4

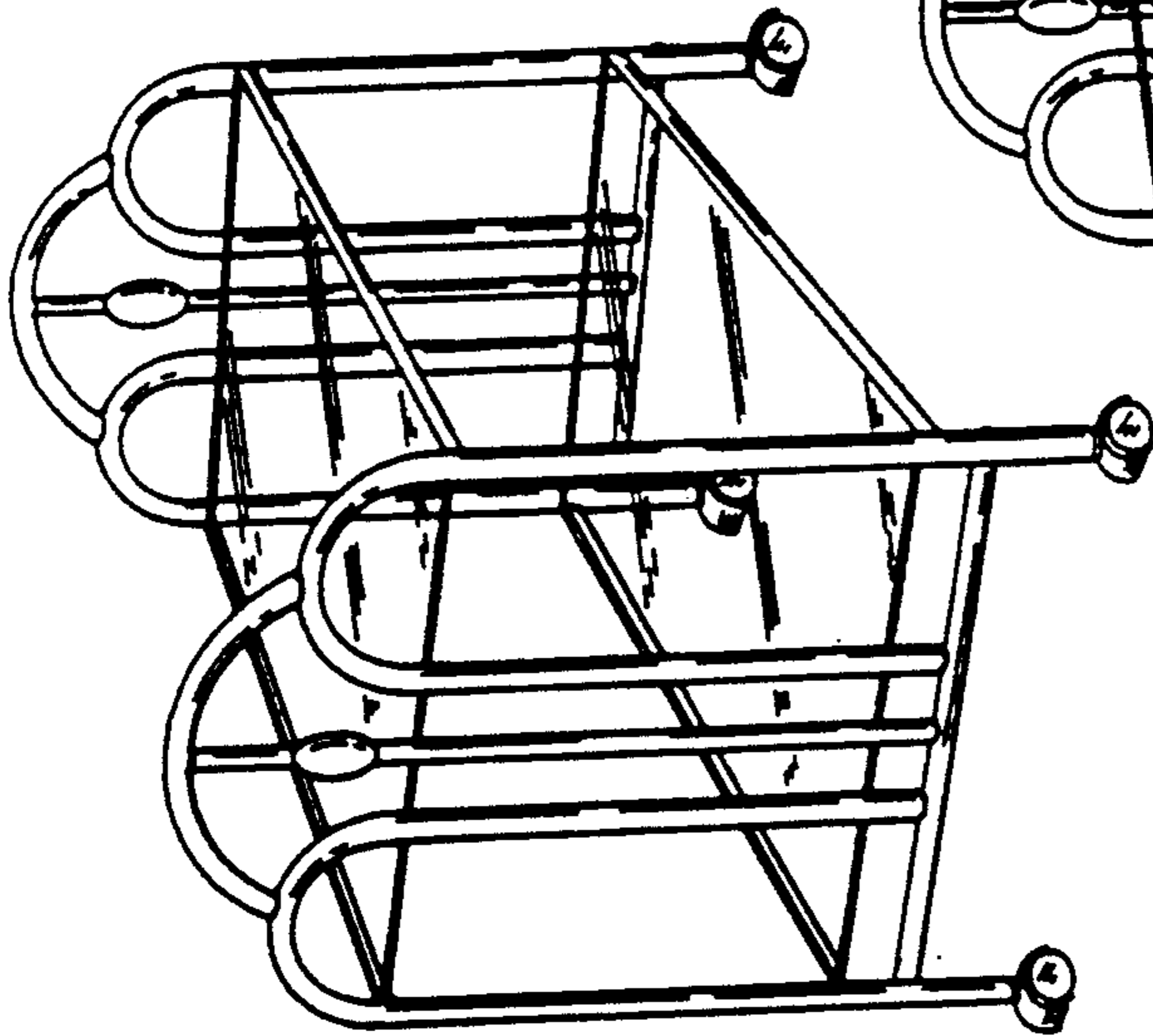

FIG. 1

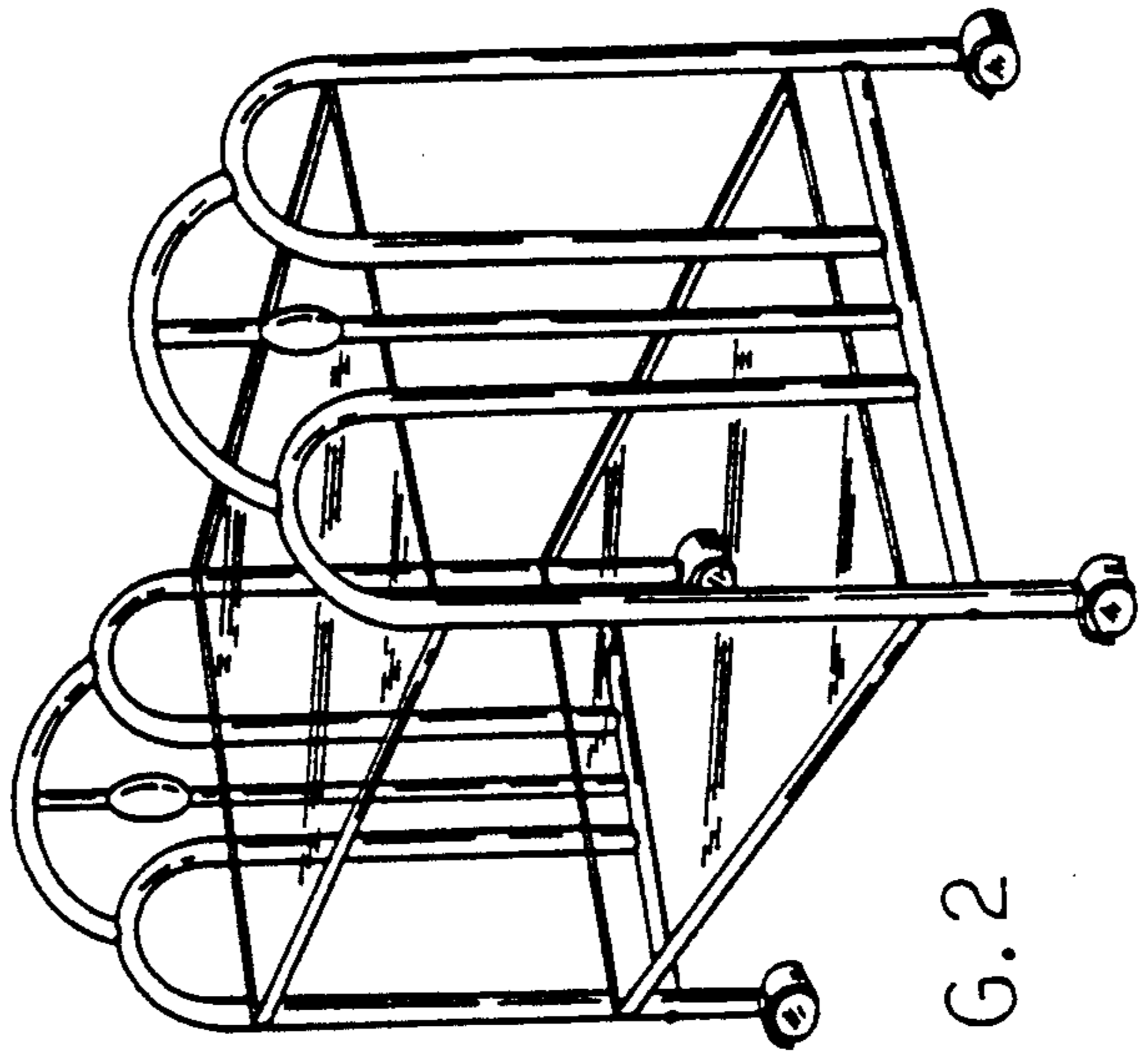

FIG. 2

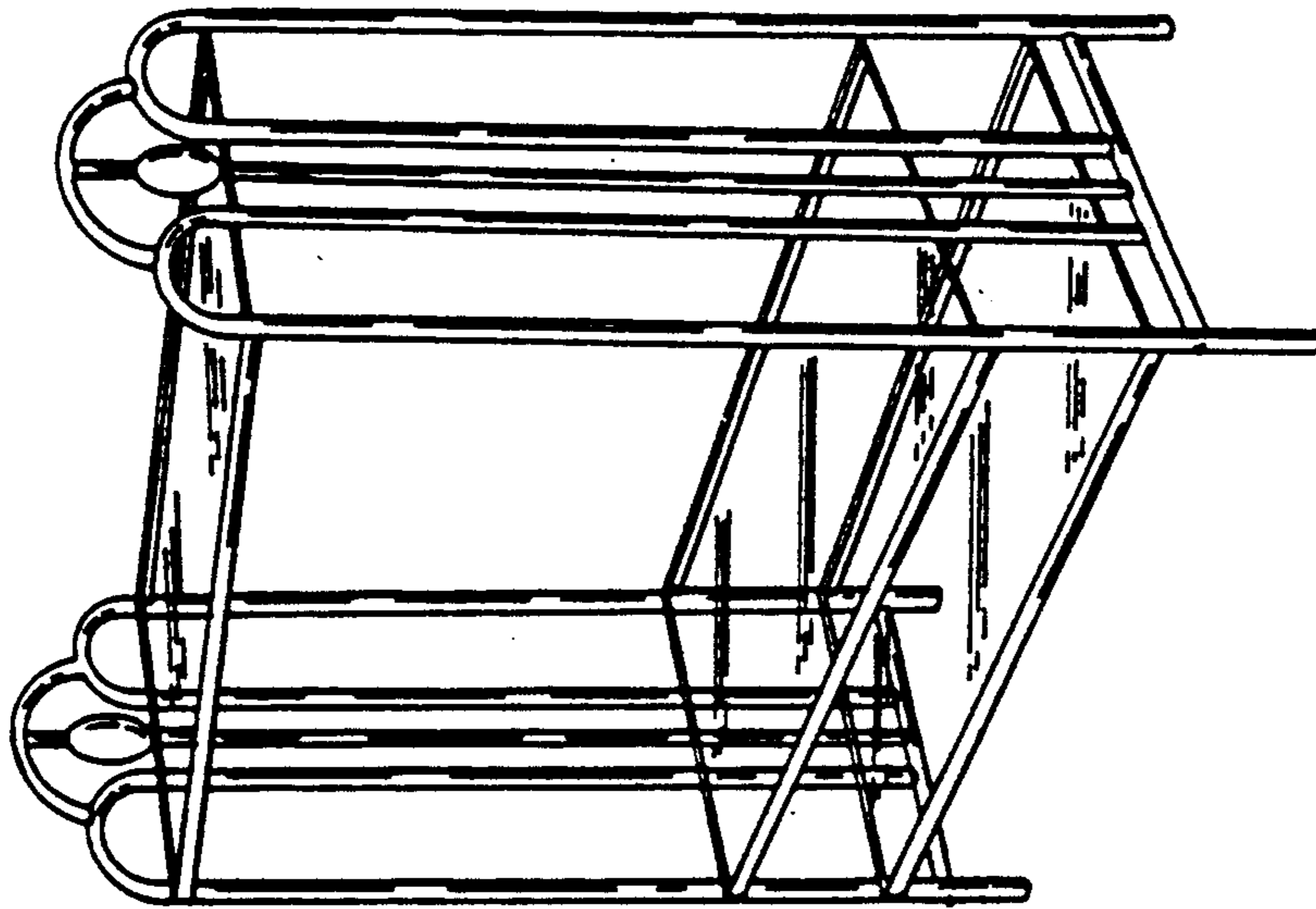

FIG. 6

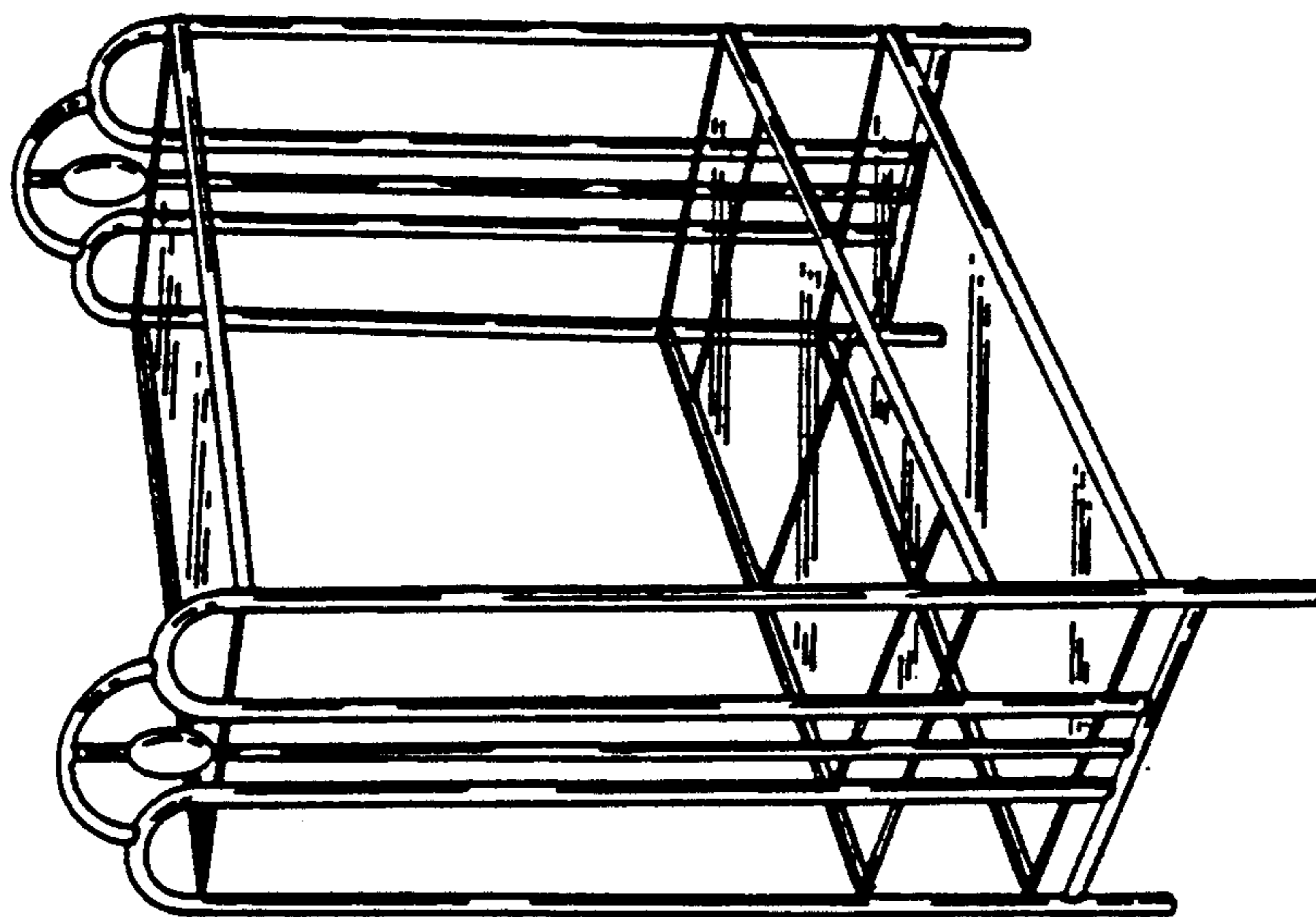

FIG. 5

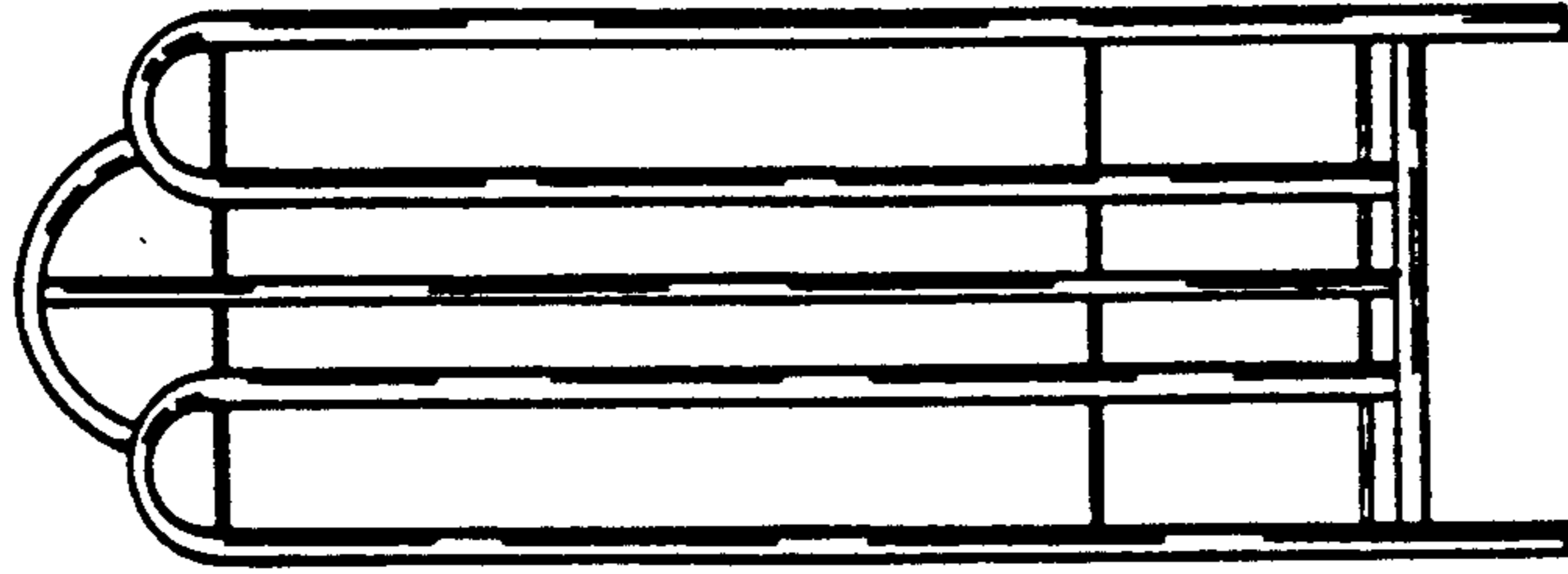

FIG. 8

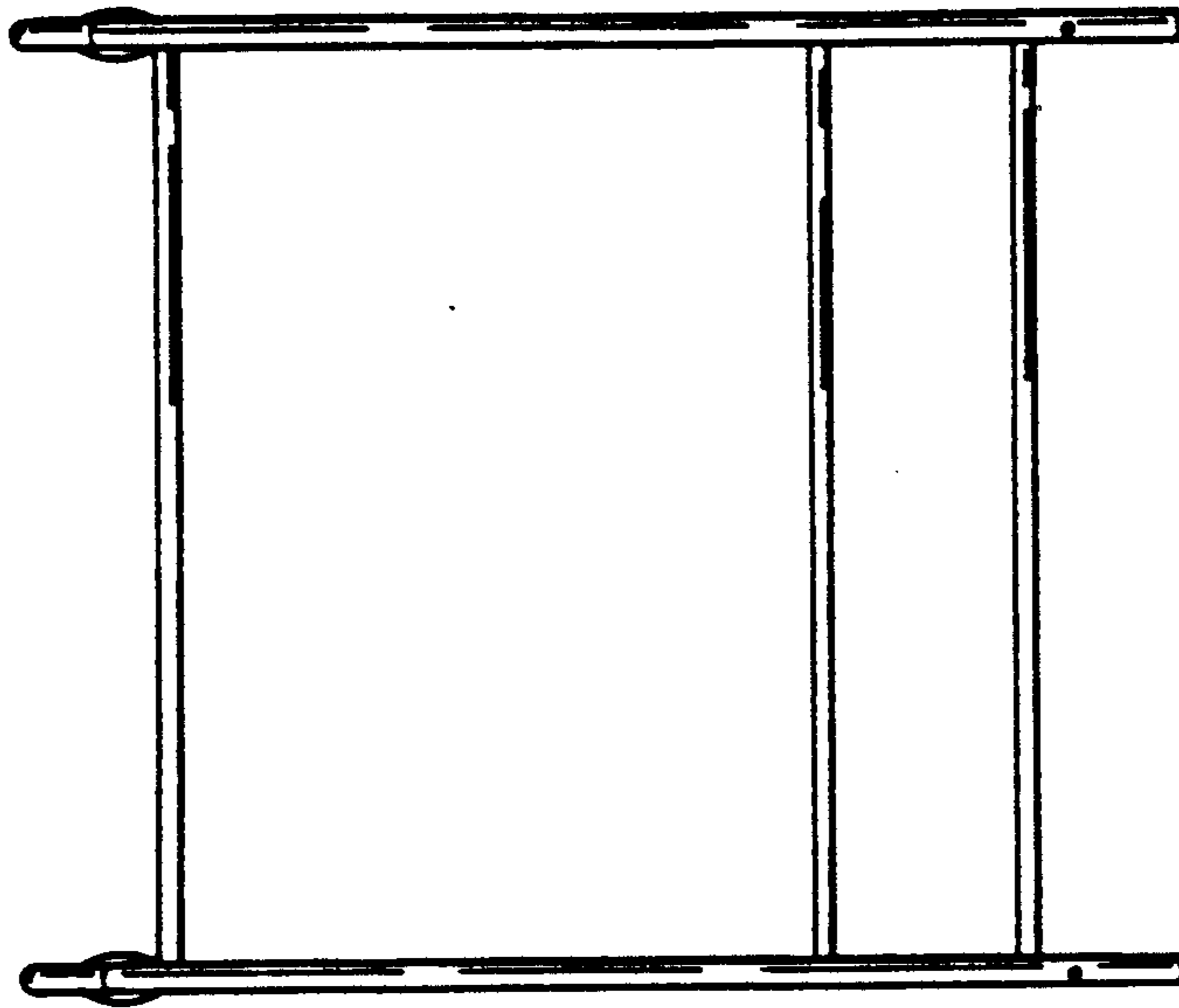

FIG. 7

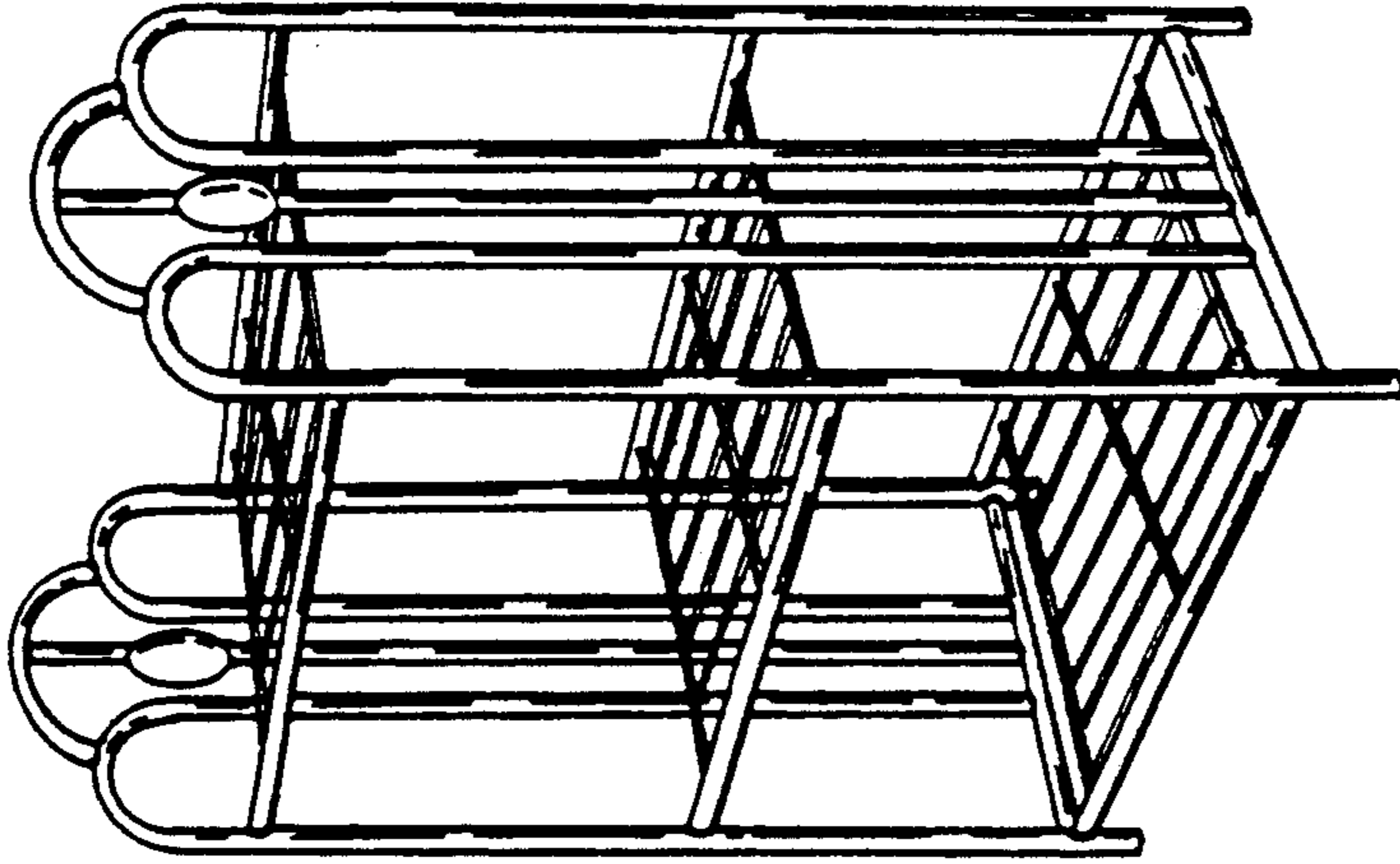

FIG. 10

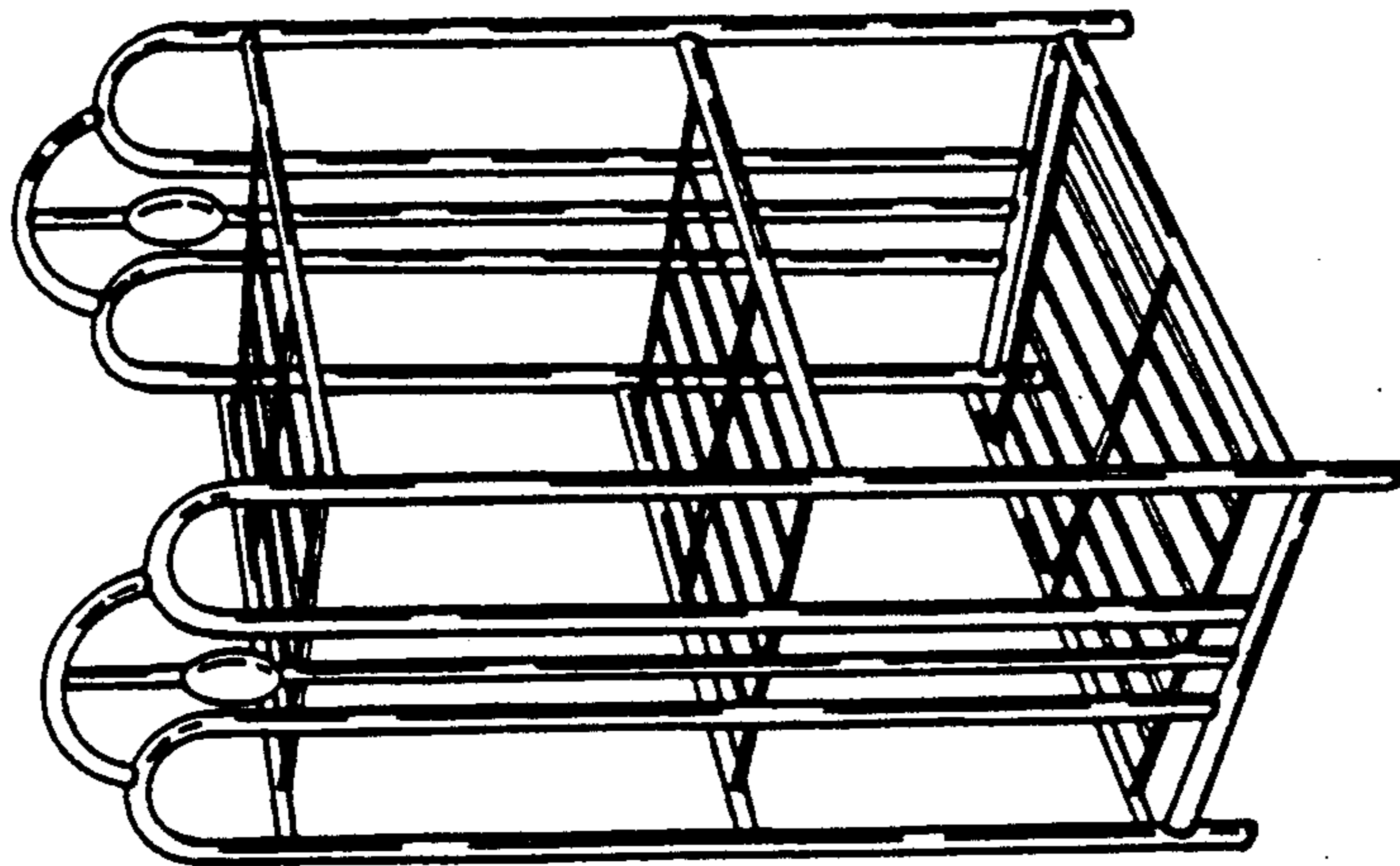

FIG. 9

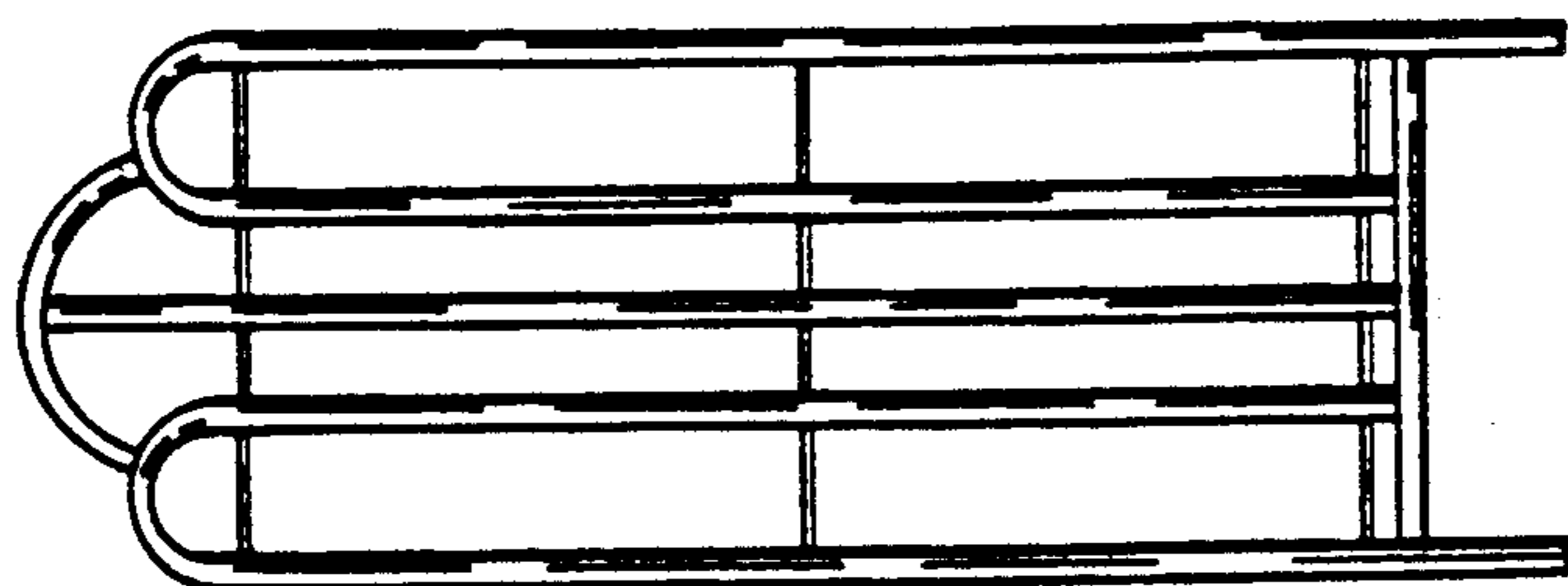

FIG. 12

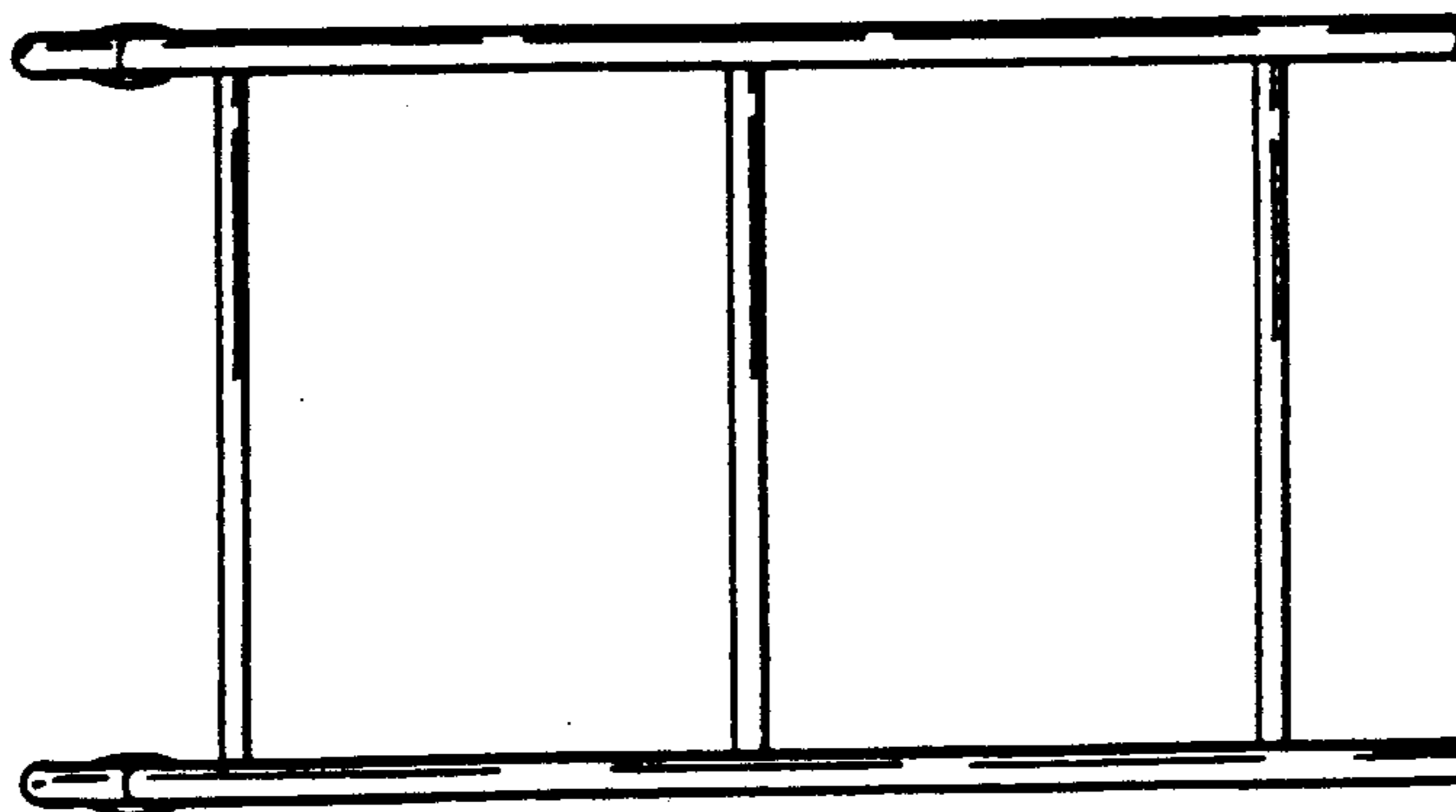

FIG. 11