

- [54] **WALL-MOUNTED GARMENT DRYER**  
 [75] **Inventor: Richard H. Rubin, Cape Town, South Africa**  
 [73] **Assignee: Richard H. Rubin Trust Panache World (Pty) Ltd., Hout Bay, South Africa**  
 [\*\*] **Term: 14 Years**  
 [21] **Appl. No.: 105,683**  
 [22] **Filed: Oct. 5, 1987**

**Related U.S. Application Data**

- [63] **Continuation-in-part of Ser. No. 700,658, Feb. 11, 1985, Pat. No. D. 292,237.**

**Foreign Application Priority Data**

- Aug. 13, 1984 [ZA] South Africa ..... 84/0762  
 [52] **U.S. Cl. .... D28/54.1; D32/8**  
 [58] **Field of Search .... D28/9-19, D28/54.1; D23/332, 33 R; D8/29.1; 34/96-101; 219/222, 366-373; 132/270, 271; D32/1, 5, 6, 8**

[56] **References Cited**

**U.S. PATENT DOCUMENTS**

- D. 197,085 12/1963 Bequette ..... D32/8  
 D. 198,706 7/1964 Jennings, Jr. .... D32/8  
 D. 216,852 3/1970 Farwick ..... D28/9  
 D. 269,819 7/1983 Froidevaux ..... D28/12  
 D. 294,741 3/1988 Froidevaux ..... D28/12

**FOREIGN PATENT DOCUMENTS**

- 0126777 12/1984 European Pat. Off. .  
 7600003 11/1976 Fed. Rep. of Germany .  
 794827 2/1936 France ..... 34/243  
 102298 of 0000 Italy .  
 254969 12/1980 Spain .  
 487425 of 0000 United Kingdom .

**OTHER PUBLICATIONS**

Hendon International Publication-undated.  
 Starmix Catalog-undated.  
 Reliance Brochure May, 1985.

*Primary Examiner*—Louis S. Zarfes  
*Attorney, Agent, or Firm*—William B. Kempler

[57] **CLAIM**

The ornamental design for wall-mounted garment dryer, as shown.

**DESCRIPTION**

FIG. 1 is a front elevational view of a wall-mounted garment dryer showing my new design;  
 FIG. 2 is a front elevational view thereof showing the handle of the hair dryer removed from the housing;  
 FIG. 3 is a left side elevational view of FIG. 1;  
 FIG. 4 is a right side elevational view of FIG. 2;  
 FIG. 5 is a bottom plan view of FIG. 1;  
 FIG. 6 is a top plan view; and  
 FIG. 7 is a rear elevational view.  
 The broken line showing of a dryer nozzle and hose in FIGS 1 and 7 is for illustrative purposes only and forms no part of the claimed design.

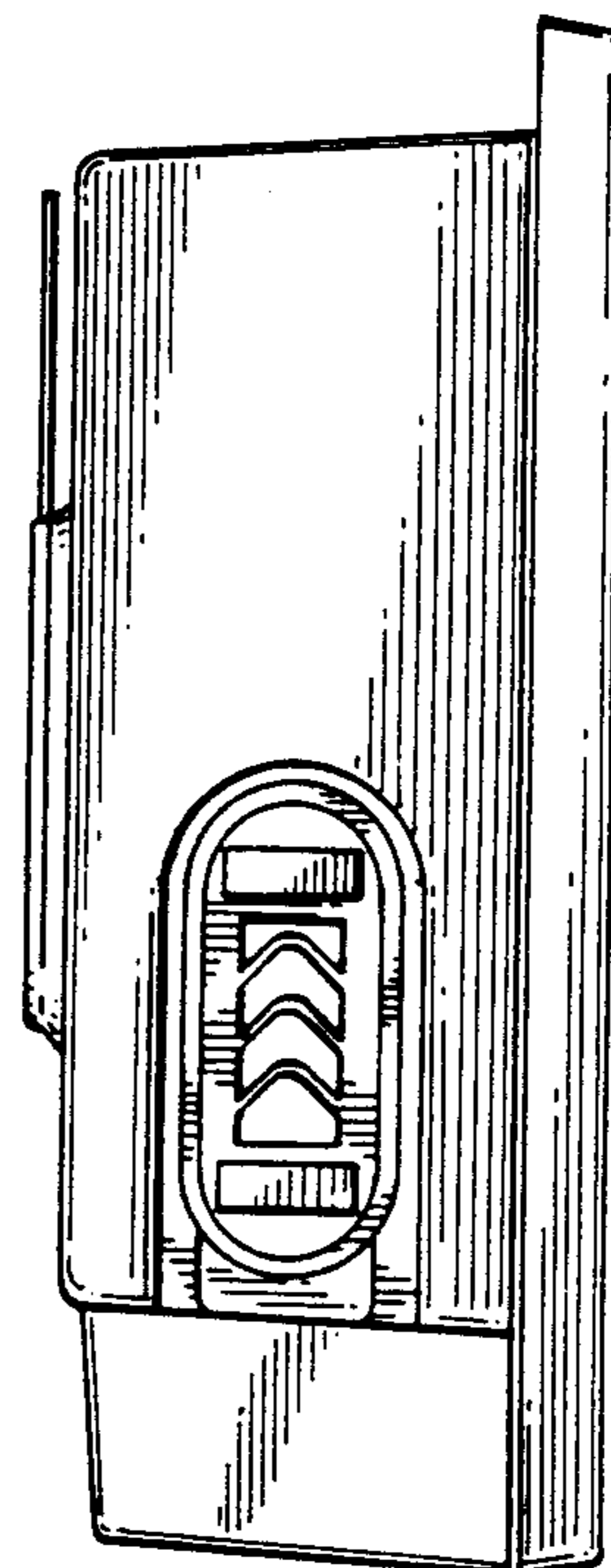
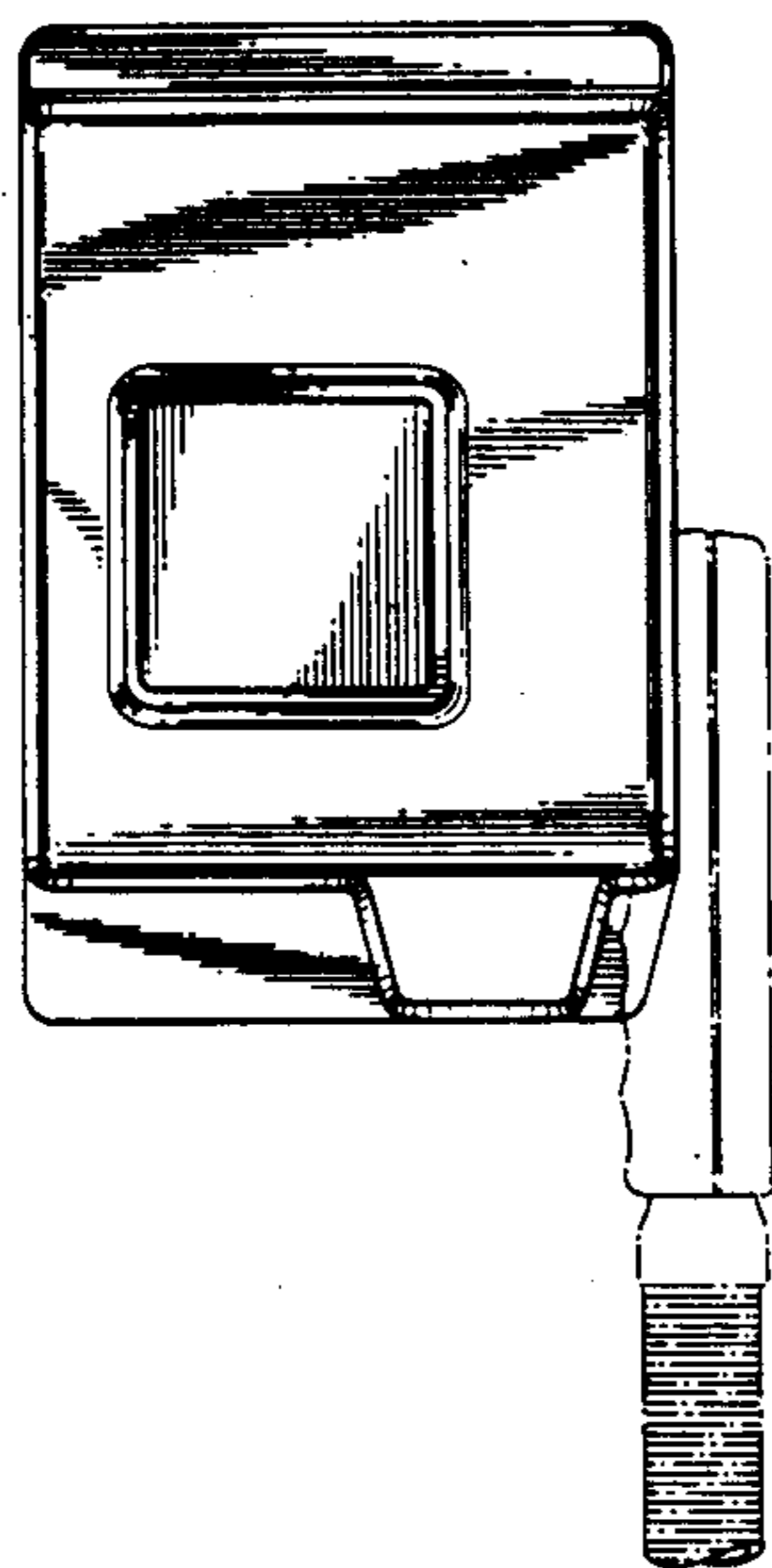

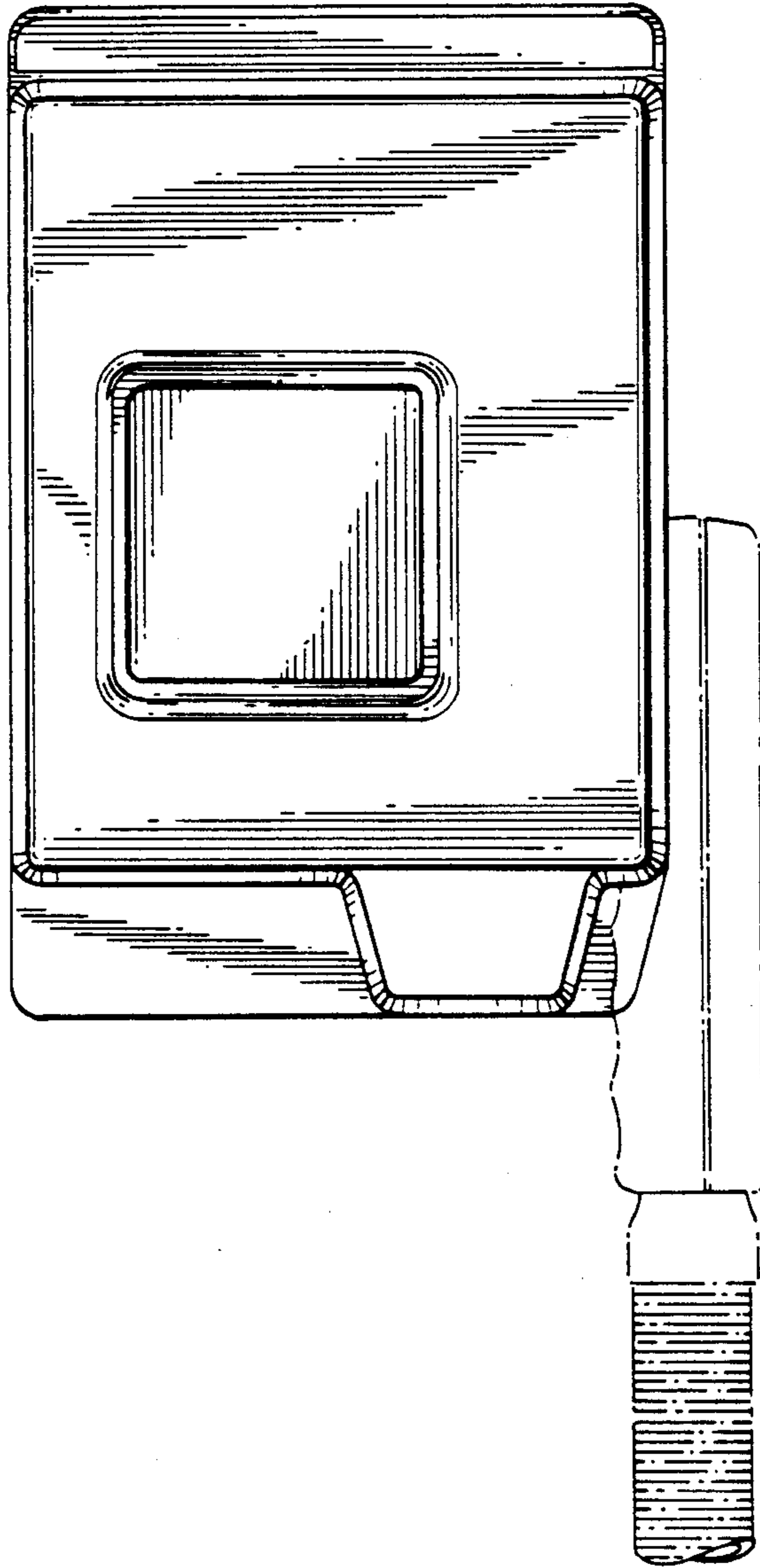

FIG. 1

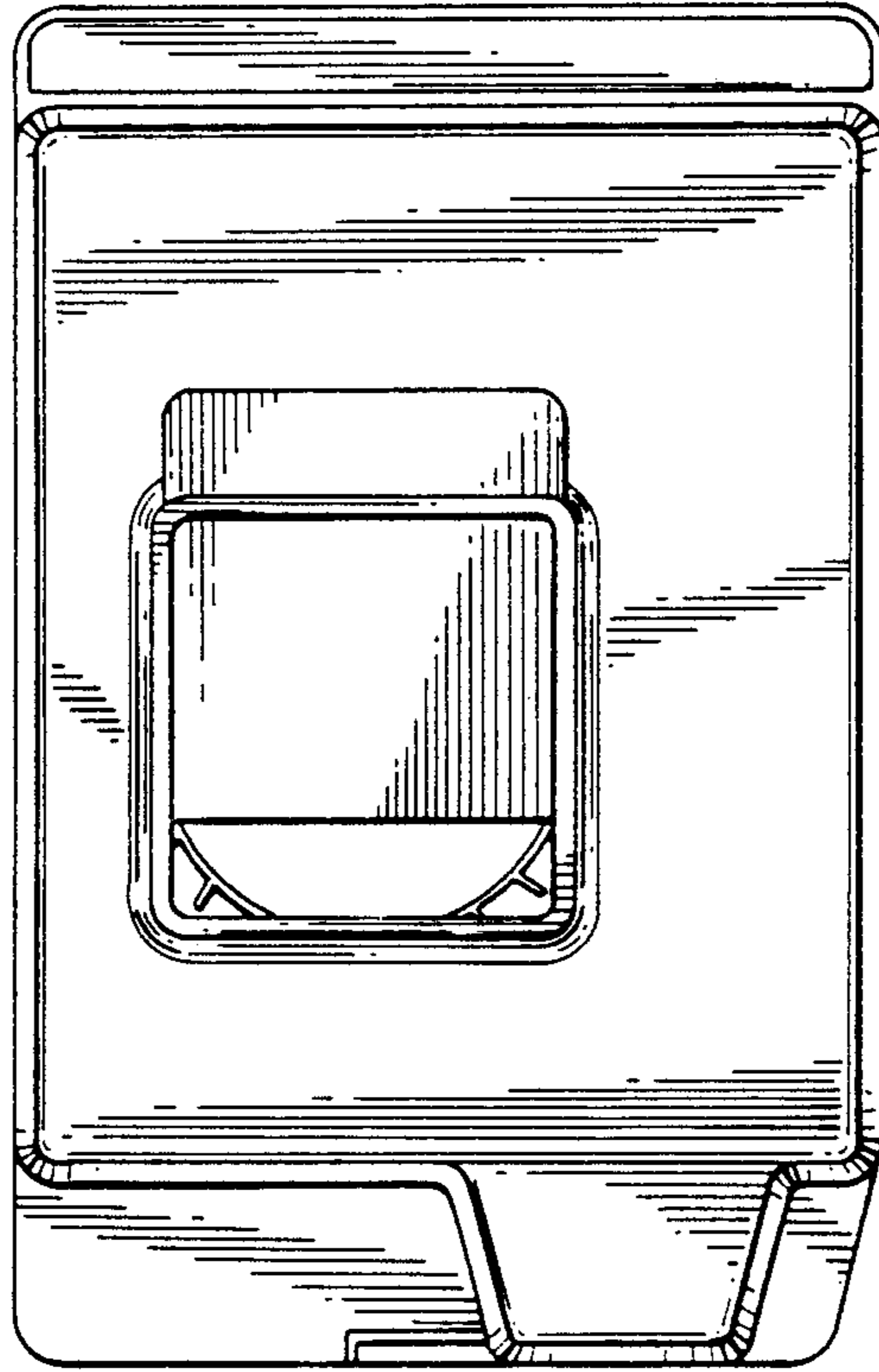

FIG. 2

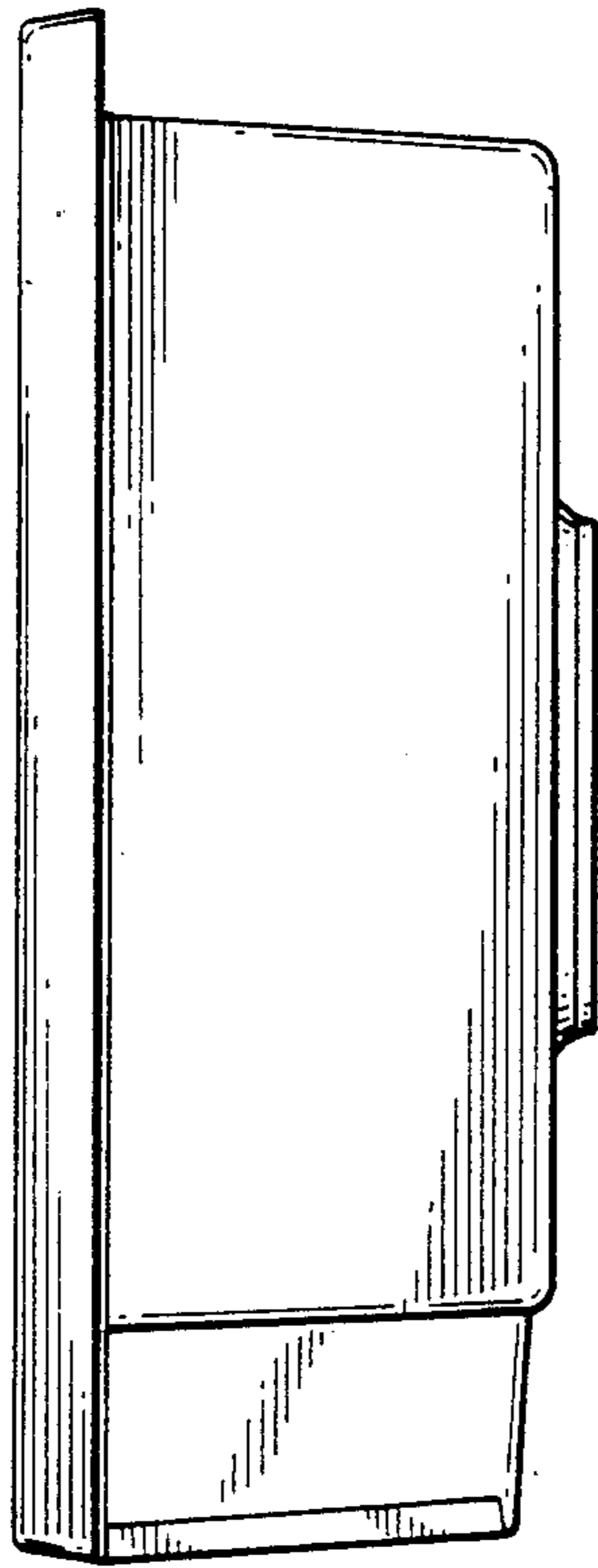

FIG. 3

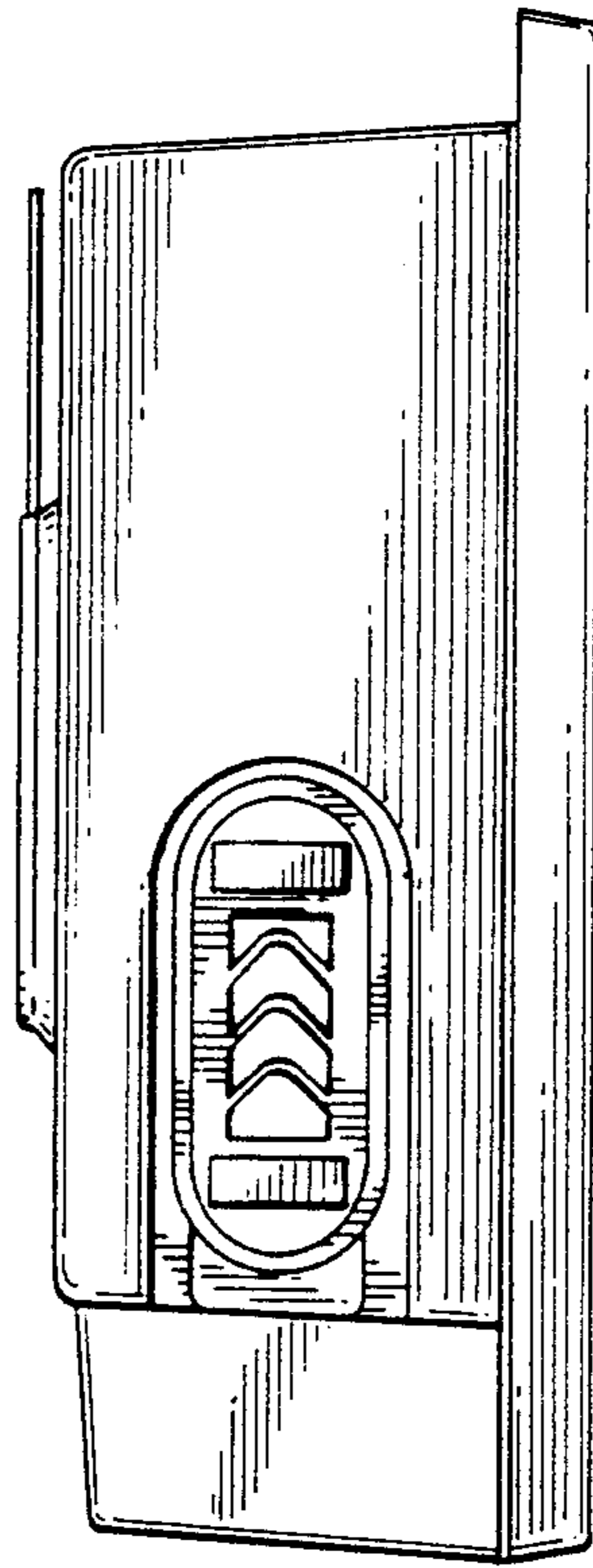

FIG. 4

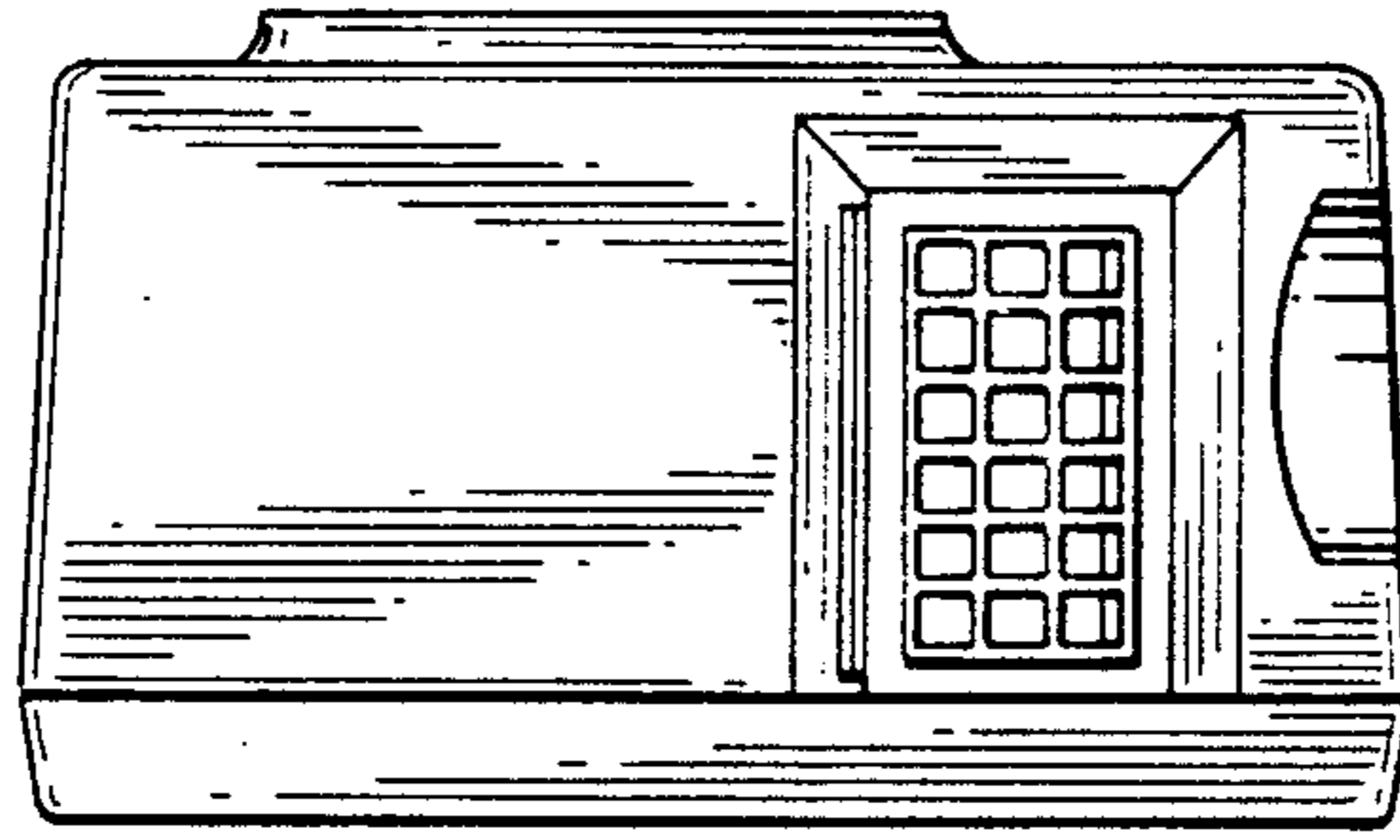

FIG. 5

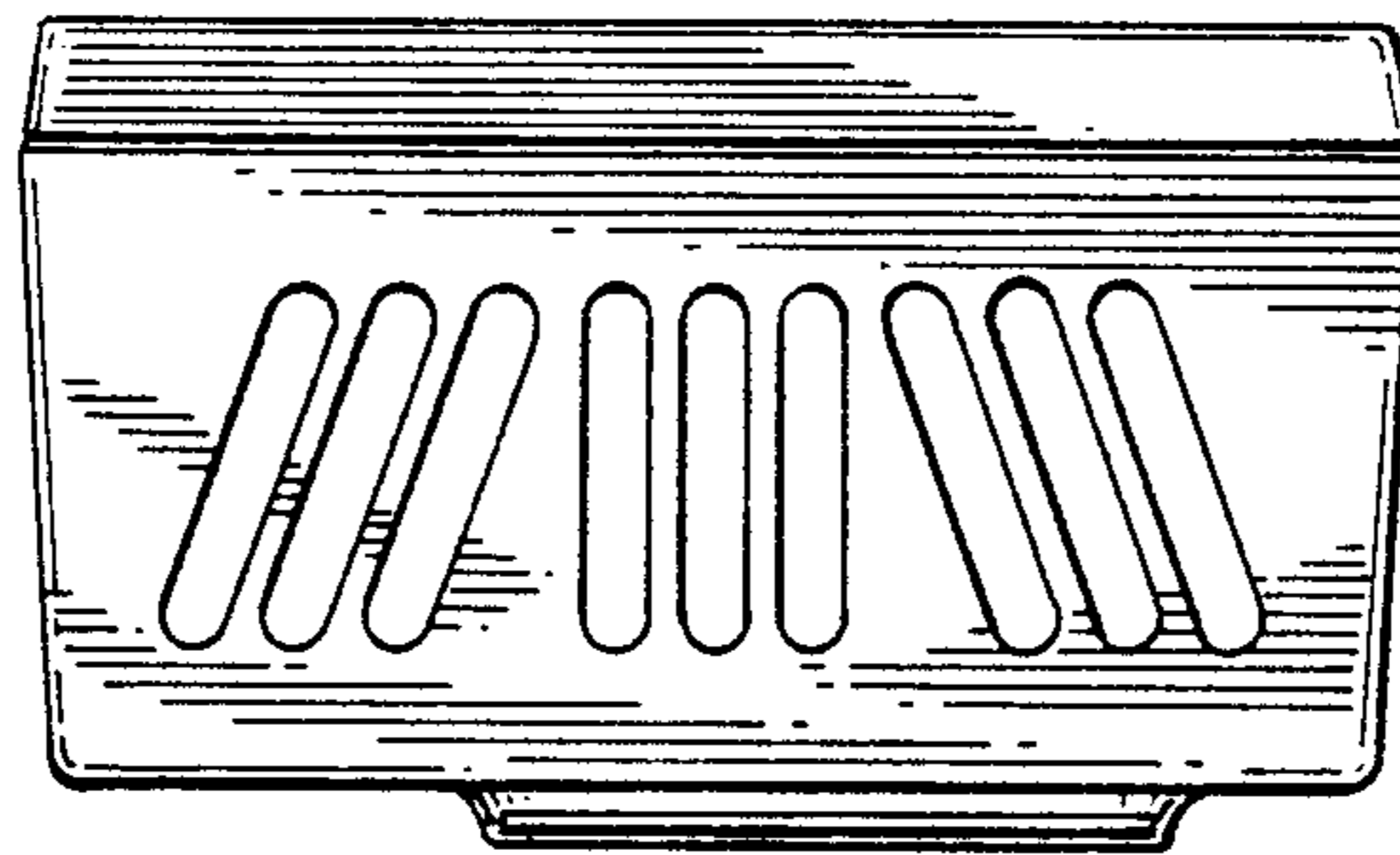

FIG. 6

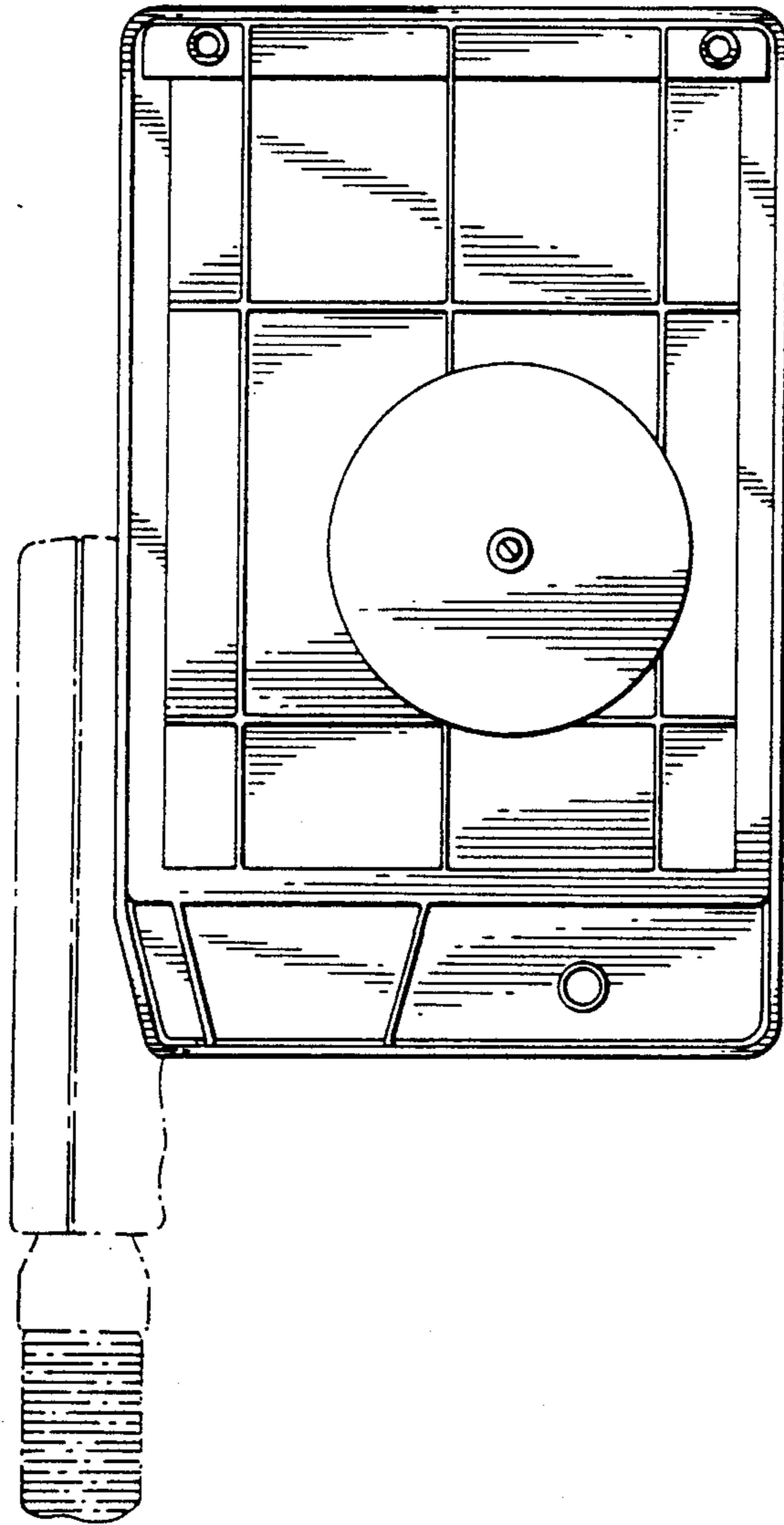

FIG. 7