

[54] **HAIR CURLING BRUSH OR SIMILAR ARTICLE**

[75] **Inventor: Elizabeth Ho, Kowloon, Hong Kong**

[73] **Assignee: Windmere Corporation, Miami Lakes, Fla.**

[\*\*] **Term: 14 Years**

[21] **Appl. No.: 257,033**

[22] **Filed: Oct. 12, 1988**

[30] **Foreign Application Priority Data**

Jun. 7, 1988 [GB] United Kingdom ..... 1051334

[52] **U.S. Cl. .... D28/35**

[58] **Field of Search .... D28/35, 37, 38; 219/222, 225; 132/219, 118, 226-230, 233, 265-269, 271, 272**

[56] **References Cited**

**U.S. PATENT DOCUMENTS**

Re. 30,618	5/1981	Van Dyck et al. ....	219/225
D. 109,118	10/1936	Allen et al. ....	D28/35
D. 276,086	10/1984	Ernest et al. ....	D28/35
D. 294,743	3/1988	Seki et al. ....	D28/35
D. 305,158	12/1989	Vackiner ....	D28/35
364,956	6/1887	Posner ....	132/263
943,321	12/1909	Shero ....	132/224
1,105,962	8/1914	Carlson ....	132/118
1,284,792	11/1918	Schwartz ....	219/225
1,465,838	8/1923	Caneavri ....	132/225
1,491,981	4/1924	Brinkman ....	132/263
1,580,370	4/1926	Dondanville et al. ....	132/118
1,605,540	11/1926	Gibney ....	132/127
1,622,834	3/1927	Marcel ....	219/225
1,630,078	5/1927	Smithszek ....	219/225 X
1,693,462	11/1928	Polnaszek ....	132/232
1,694,672	12/1928	Rogler ....	132/225
1,719,232	7/1929	Meade ....	132/223 X
1,937,004	11/1933	Anderson ....	132/118
2,550,295	4/1951	Price ....	132/263
2,611,378	9/1952	King et al. ....	132/259
2,730,109	1/1956	Coakley et al. ....	132/256
3,102,941	9/1963	Pope ....	132/232
3,224,454	12/1966	Quinio et al. ....	219/225 UX
3,491,774	1/1970	Carbone ....	132/272
3,516,420	6/1970	Porter ....	219/225
3,731,694	5/1973	Moro ....	132/118
3,847,166	11/1974	Carr ....	132/269

3,859,497	1/1975	McNair .....	219/225
3,935,423	1/1976	Pucci .....	219/225
3,937,230	2/1976	Kenny .....	132/232
3,955,064	5/1976	Demetrio et al. ....	219/225
4,024,375	5/1977	Olesen et al. ....	219/225
4,034,201	7/1977	Walter et al. ....	219/222

(List continued on next page.)

**FOREIGN PATENT DOCUMENTS**

502638	5/1951	Belgium .
550696	9/1956	Belgium .
1015238	8/1977	Canada .
1060518	8/1979	Canada .
0021941	1/1981	European Pat. Off. .
0053942	6/1982	European Pat. Off. .
2615267	10/1977	Fed. Rep. of Germany .
3535831A	4/1987	Fed. Rep. of Germany .
669479	2/1929	France .
940409	2/1947	France .

(List continued on next page.)

**OTHER PUBLICATIONS**

Hong Kong Enterprise 11/87, p. 213, top right of page, top and middle Curling Brushes.  
Wahl Curling Irons-undated.

*Primary Examiner*—Bernard Ansher  
*Assistant Examiner*—C. Tuttle  
*Attorney, Agent, or Firm*—Dickstein, Shapiro & Morin

[57] **CLAIM**

The ornamental design for the hair curling brush or similar article, as shown and described.

**DESCRIPTION**

FIG. 1 is a top plan view of a hair curling brush, or similar article showing my new design;  
FIG. 2 is a left side elevational view thereof;  
FIG. 3 is a bottom plan view thereof;  
FIG. 4 is a right side elevational view thereof;  
FIG. 5 is an end elevational view thereof, viewed from the left of FIG. 1; and  
FIG. 6 is an end elevational view thereof, viewed from the right of FIG. 1.  
The fragmentary portion is shown in FIGS. 1-6 for ease of illustration.

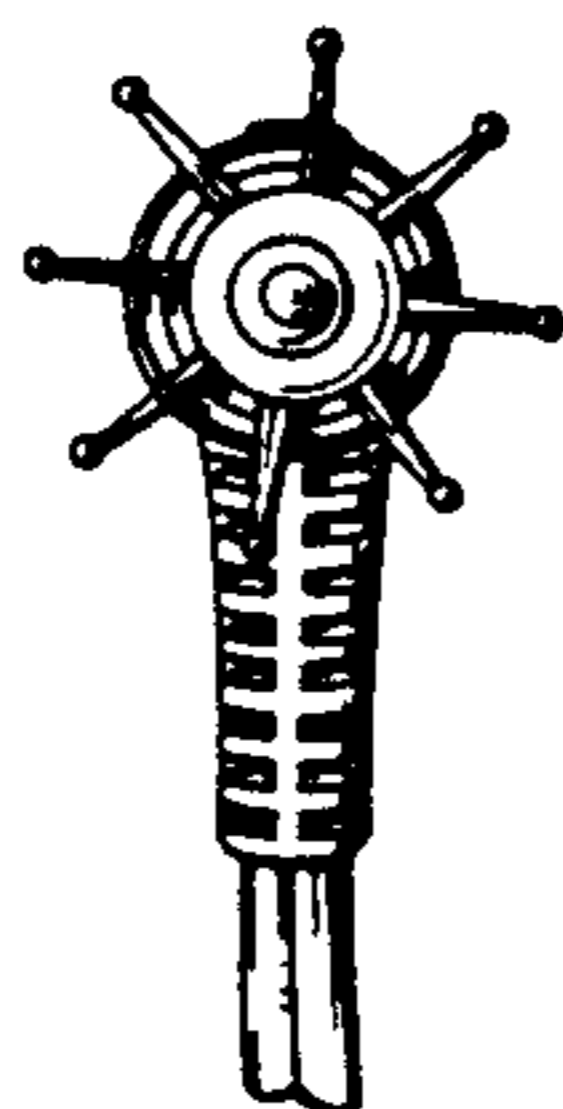
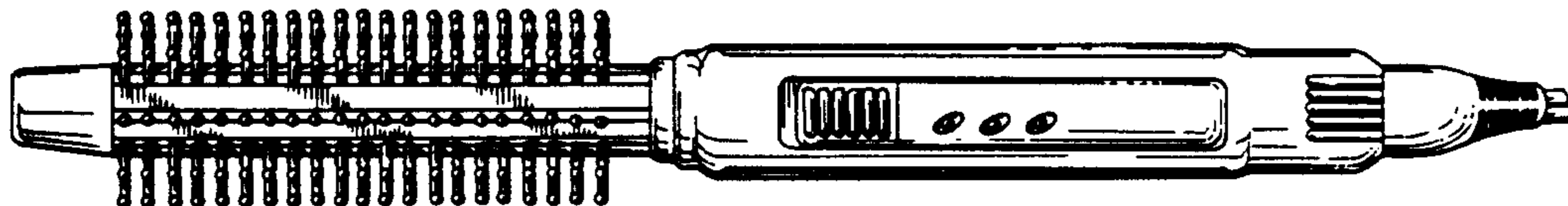

## U.S. PATENT DOCUMENTS

4,075,458	2/1978	Moyer	219/225
4,101,757	7/1978	Van Dyck et al.	219/225
4,163,143	7/1979	Federico et al.	219/225
4,227,541	10/1980	Satchell	219/228 X
4,228,343	10/1980	Kanner et al.	219/225
4,267,430	5/1981	Downey	219/222
4,267,431	5/1981	Rick et al.	219/225
4,314,137	2/1982	Dorn	219/222
4,354,092	10/1982	Manabe et al.	219/225
4,365,140	12/1982	Bast et al.	219/225
4,426,567	1/1984	Gugliotti	219/225
4,430,808	2/1984	Toyomi et al.	34/97
4,464,562	8/1984	Takimae	219/225
4,477,716	10/1984	Thaler et al.	219/225
4,479,047	10/1984	Khaja et al.	219/225
4,492,241	1/1985	Thaler et al.	219/222 X
4,567,904	2/1986	Pitcher et al.	219/225 X
4,581,519	4/1986	Thaler et al.	219/225
4,604,514	8/1986	Thaler et al.	219/225
4,623,779	11/1986	Raab	132/229 X
4,641,010	2/1987	Abura et al.	219/222

4,697,066	9/1987	Glucksman	219/225
4,860,775	8/1989	Reeves et al.	132/229 X

## FOREIGN PATENT DOCUMENTS

2310105	11/1976	France	.
50012468	1/1950	Japan	.
54135062	10/1979	Japan	.
58-92307	9/1981	Japan	.
452728	5/1981	Switzerland	.
366532	2/1932	United Kingdom	.
1326121	8/1973	United Kingdom	219/225
1358562	7/1974	United Kingdom	.
2021943A	12/1979	United Kingdom	219/222
2032271A	5/1980	United Kingdom	.
2082908A	3/1982	United Kingdom	.
481808	3/1983	United Kingdom	.
2106384A	4/1983	United Kingdom	.
2133686A	8/1984	United Kingdom	.
2141927A	1/1985	United Kingdom	.
2154408A	9/1985	United Kingdom	.
2167953A	6/1986	United Kingdom	.
2174896A	11/1986	United Kingdom	.

FIG. 1

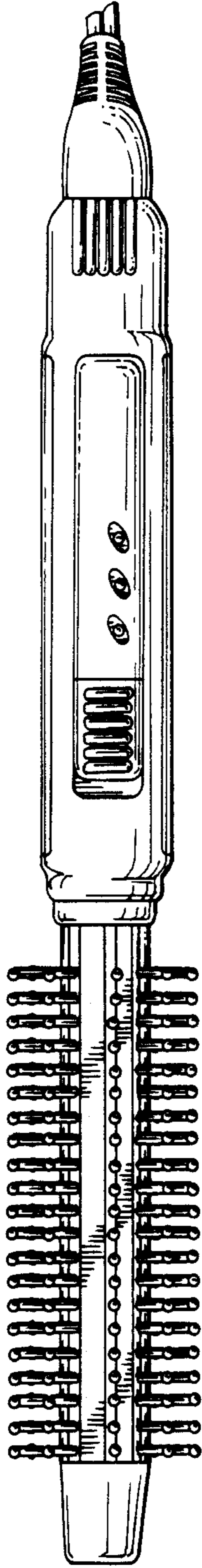

FIG. 5

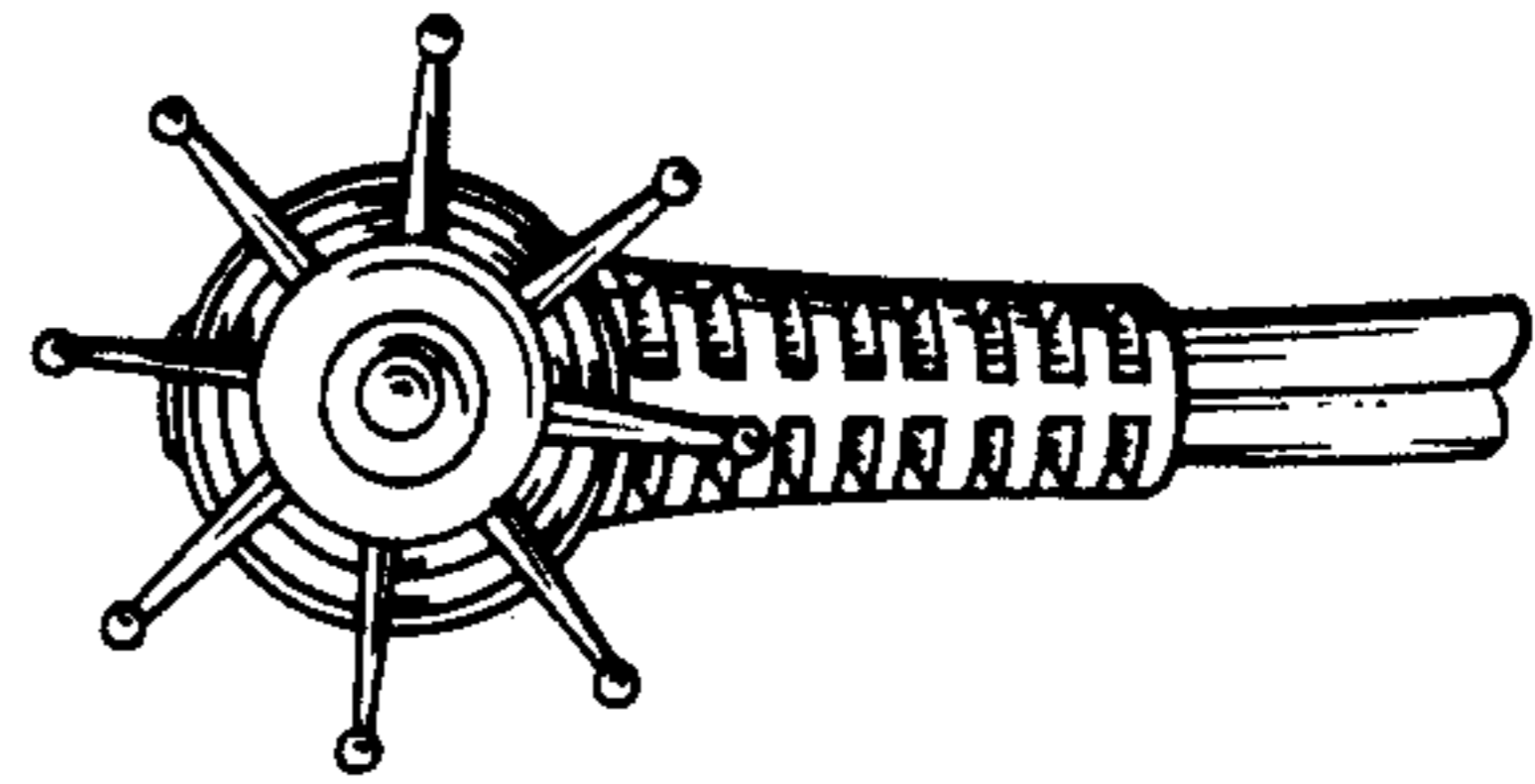

FIG. 6

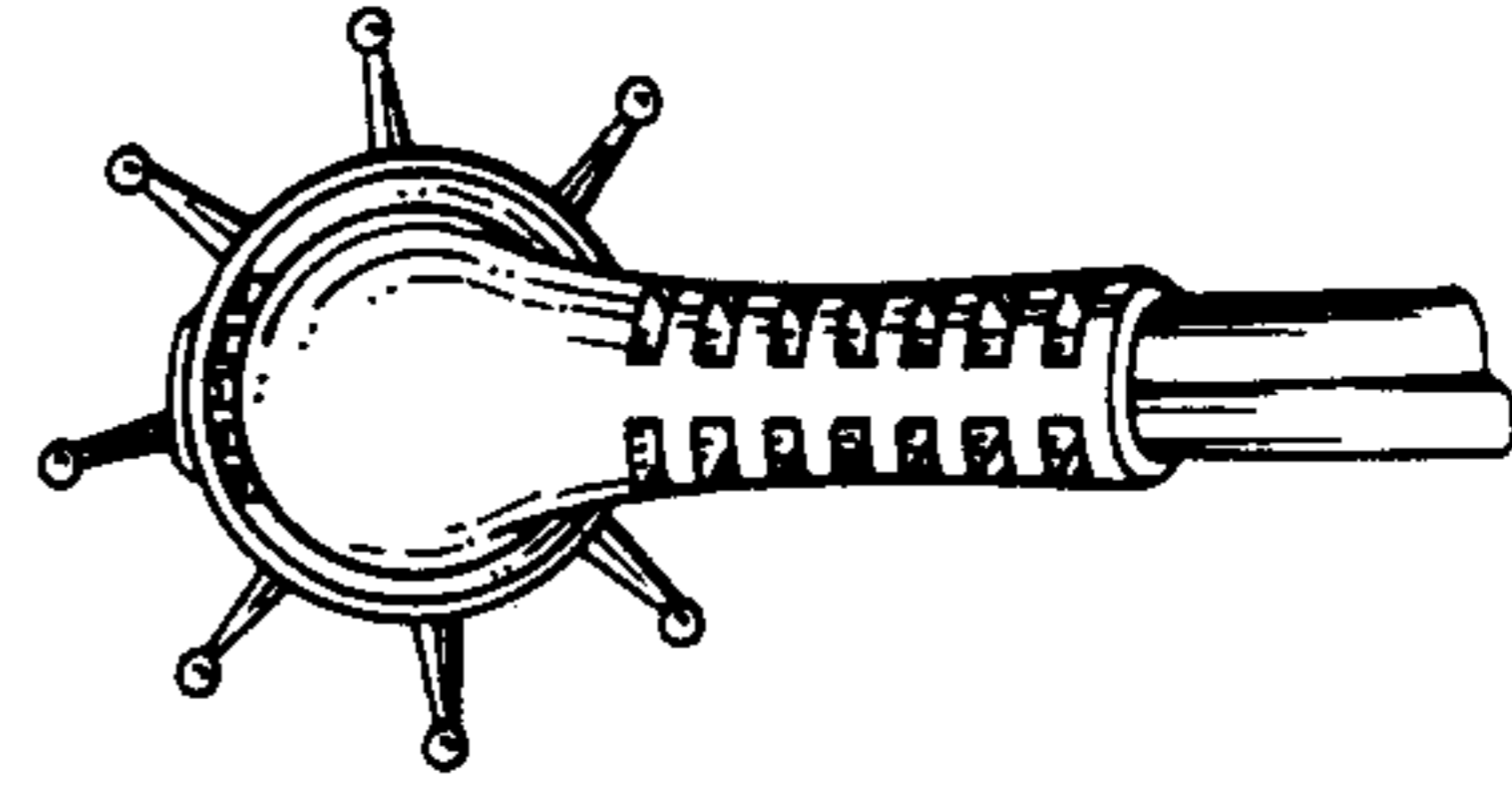



FIG. 2

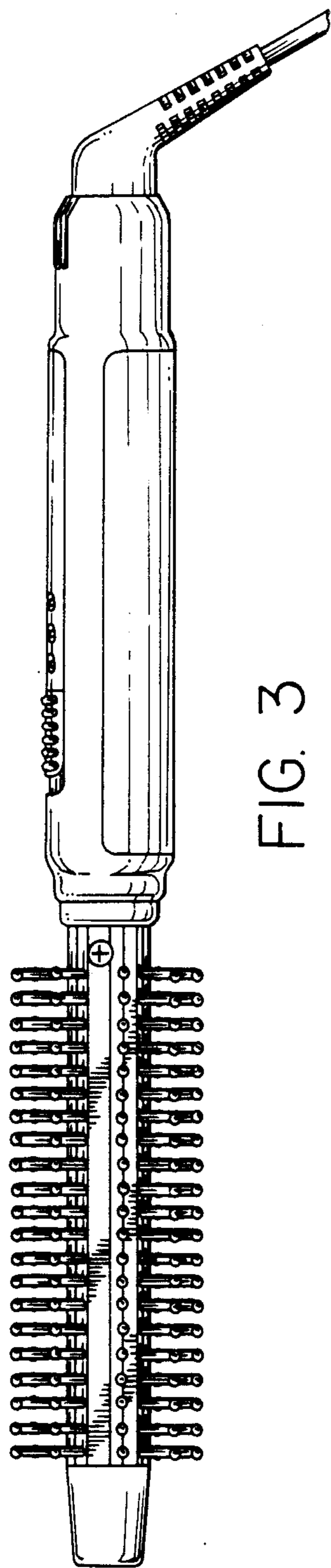

FIG. 3

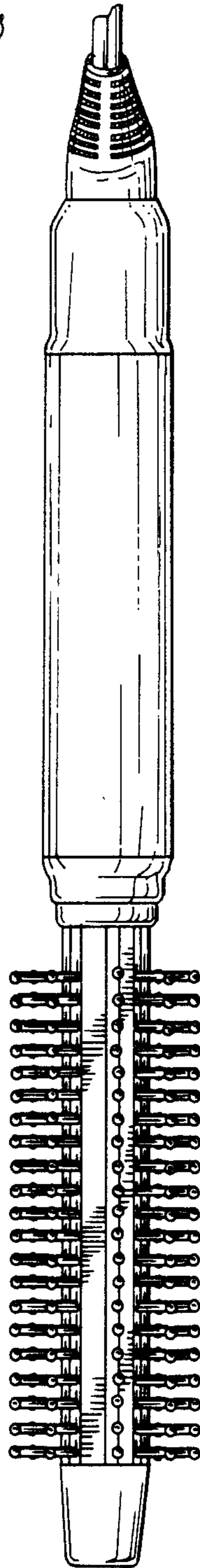

FIG. 4

