

[54] **BOWLING BALL ABRADING DEVICE**

[76] **Inventor: Michael G. Gordon, 4997
Chadbourne, Sterling Heights, Mich.
48310**

[**] **Term: 14 Years**

[21] **Appl. No.: 45,667**

[22] **Filed: May 1, 1987**

[52] **U.S. Cl. D21/233**

[58] **Field of Search D8/90, 91, 92, 93;
D21/233; 15/118, 407; 51/4, 204, 391; 273/54
R, 37**

[56] **References Cited**

U.S. PATENT DOCUMENTS

D. 130,805	12/1941	Roberts	D21/233
D. 131,307	2/1942	Rothe et al.	D8/90
D. 213,386	2/1969	Sheffer	D8/90
D. 228,616	10/1973	Tomo	D8/90
D. 293,166	12/1987	Caswell	D8/90
1,741,783	12/1929	Lower	273/54 R
2,021,150	11/1935	Leonard	.	
2,339,573	1/1944	Knipp	273/54 R
2,588,714	3/1952	Fleming	51/4
2,924,457	2/1960	Michaels et al.	273/54 R

3,451,682	6/1969	Trimble	273/127 R
3,513,821	5/1970	Bouvier	D8/90
3,769,760	11/1973	Kritscke	.	
3,998,012	12/1976	Ness	.	
4,206,574	6/1980	Dotsko	.	

Primary Examiner—Charles A. Rademaker
Assistant Examiner—Alicia A. Farrell
Attorney, Agent, or Firm—Brooks & Kushman

[57] **CLAIM**

The ornamental design for a bowling ball abrading device, as shown.

DESCRIPTION

FIG. 1 is a side elevational view of a bowling ball abrading device showing my new design;
FIG. 2 is a top plan view thereof;
FIG. 3 is a bottom plan view thereof;
FIG. 4 is a top plan view of a second embodiment of the design shown in FIGS. 1 through 3 thereof, the side elevational view being identical to FIG. 1;
FIG. 5 is a bottom plan view thereof;
FIG. 6 is a side elevational view of a third embodiment of the design shown in FIGS. 1 through 3, all sides being identical;
FIG. 7 is a top plan view thereof; and
FIG. 8 is a bottom plan view thereof.

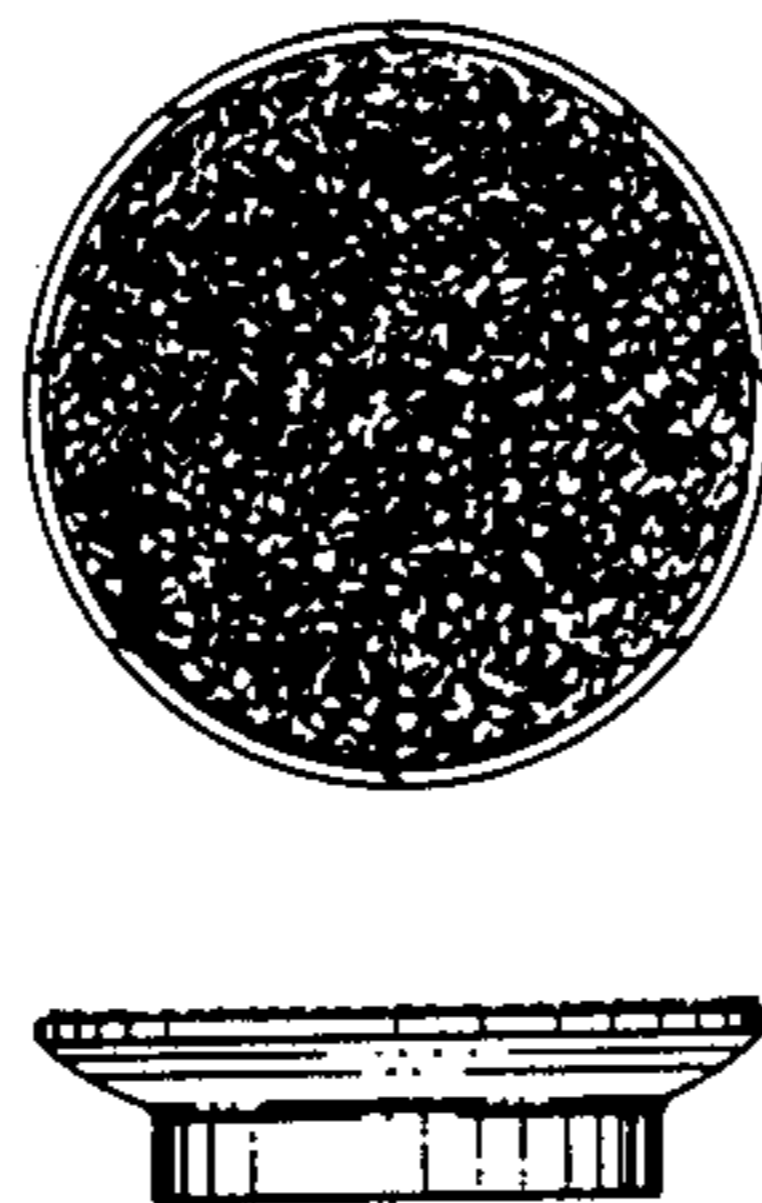

FIG. 2

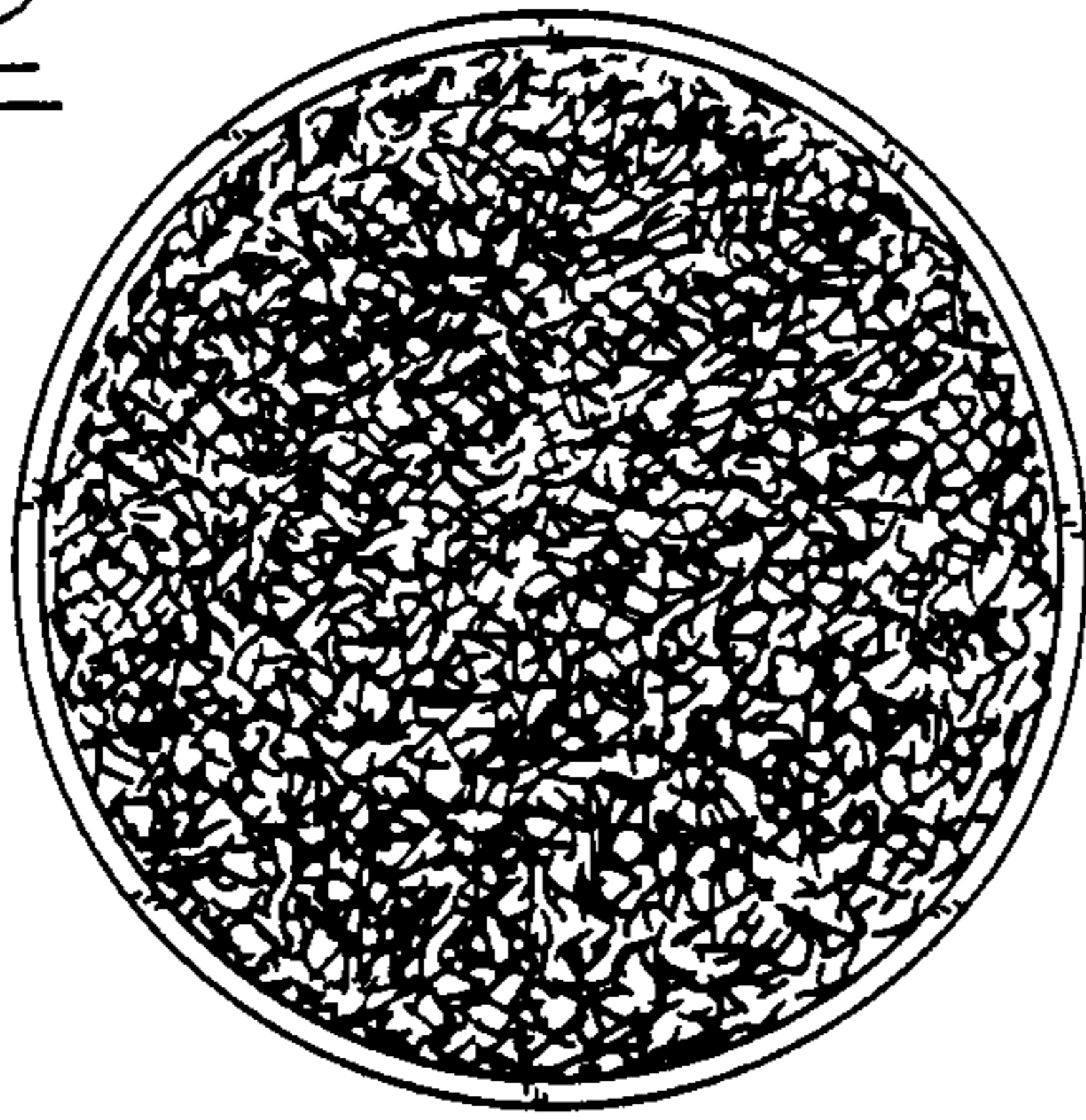

FIG. 3

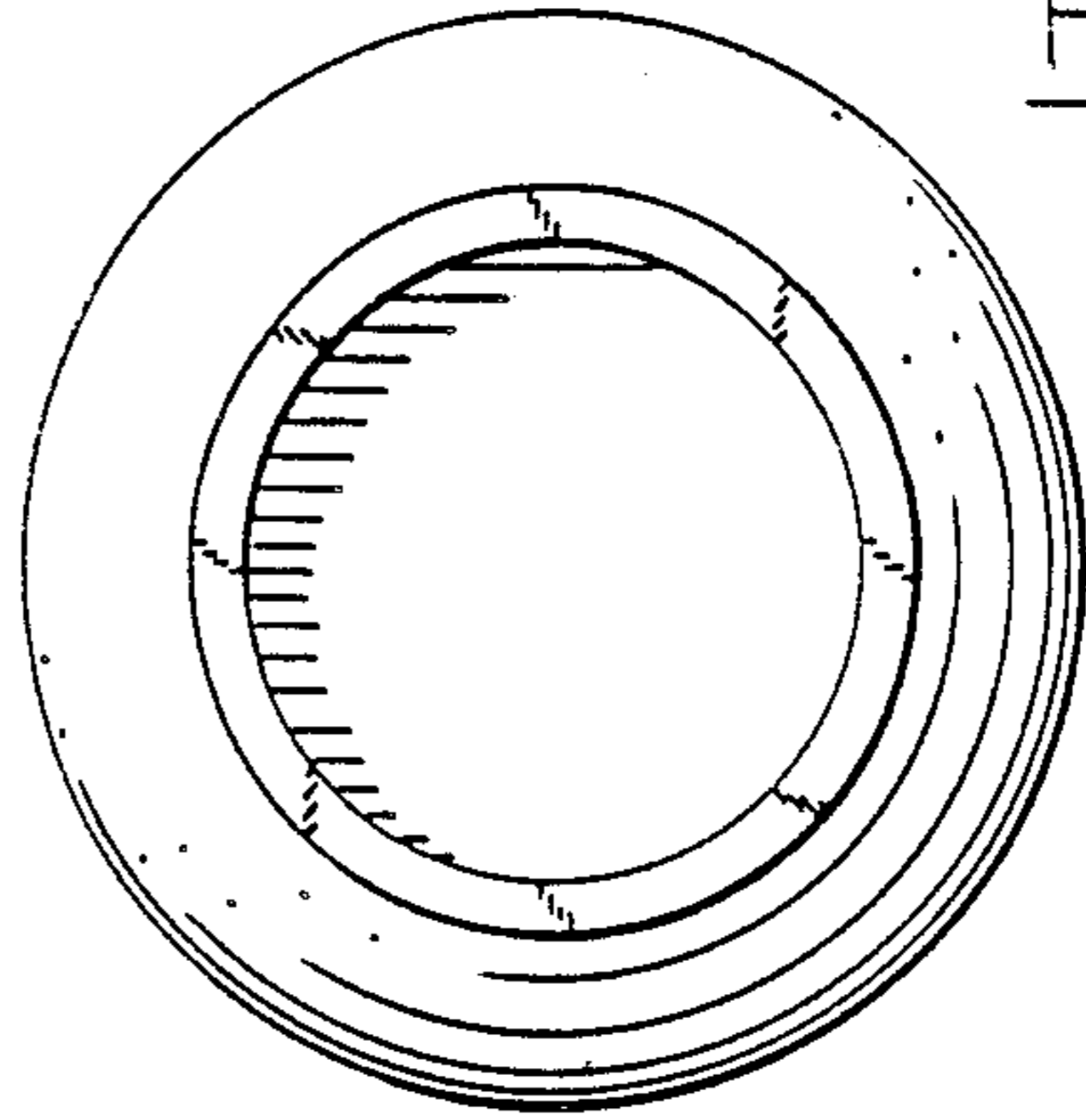

FIG. 1

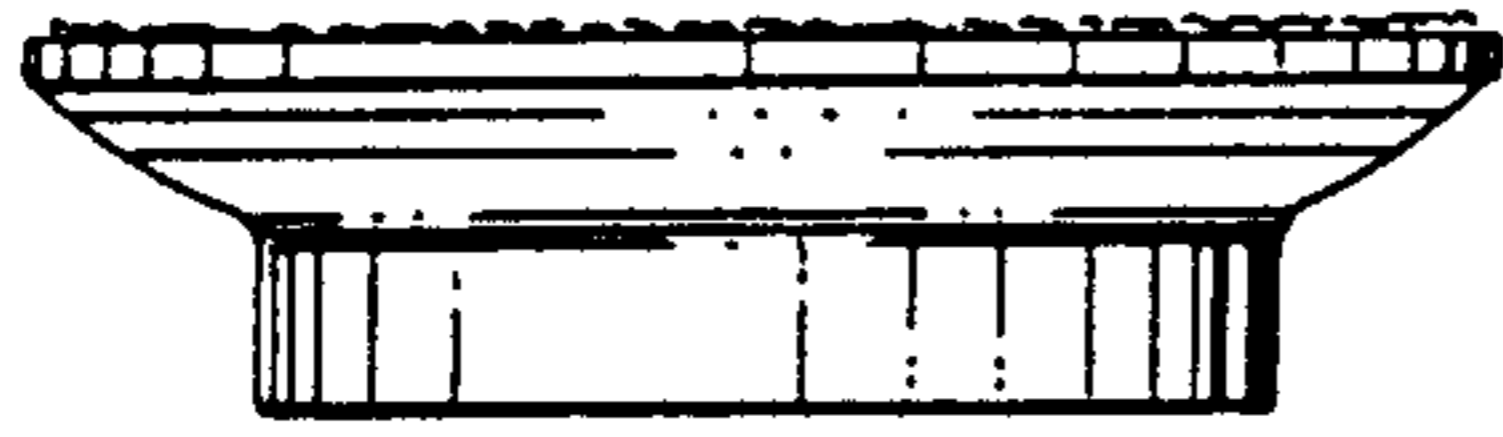

FIG. 7

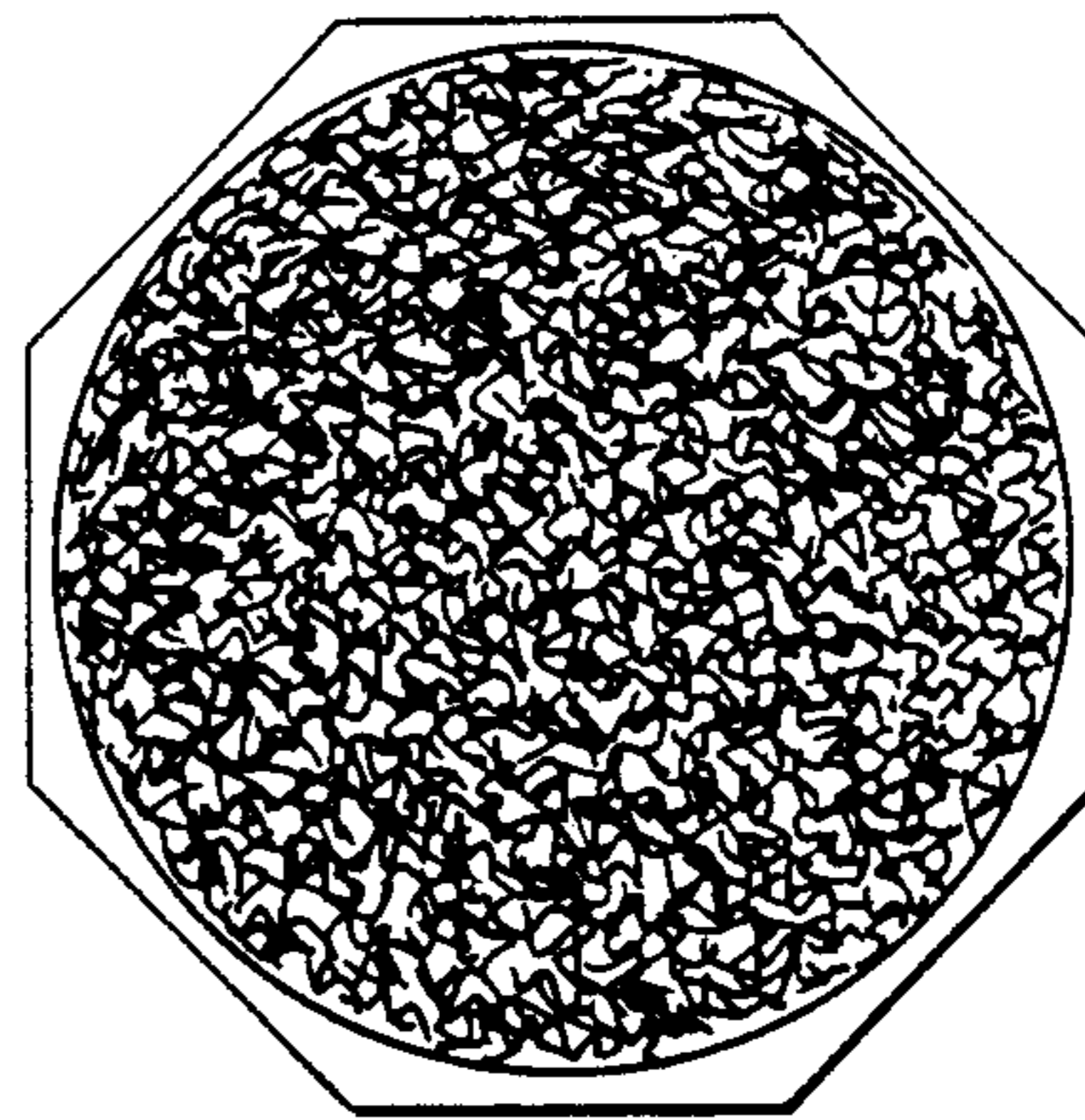

FIG. 4

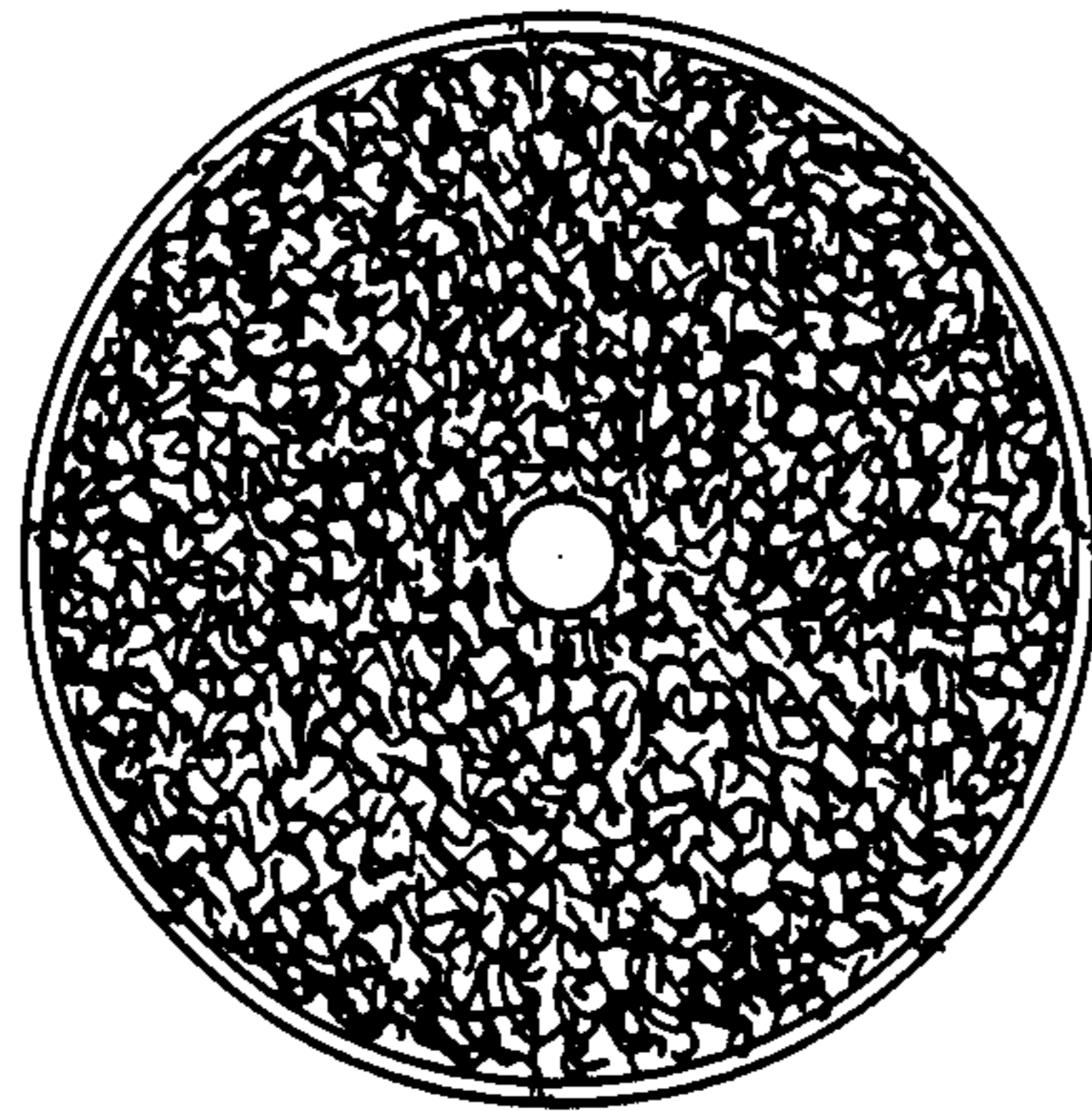

FIG. 6

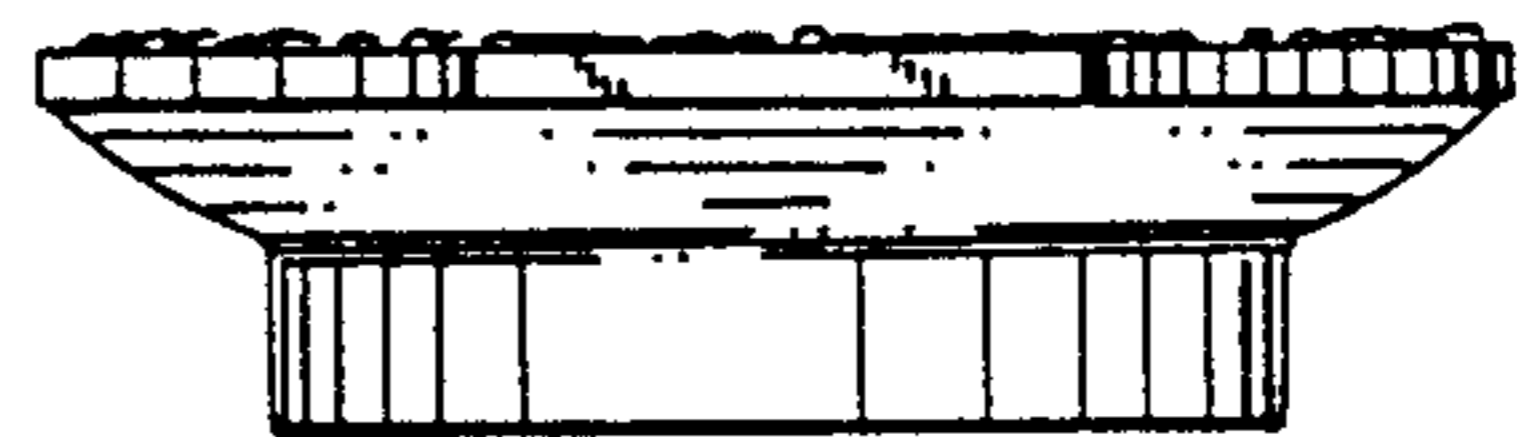

FIG. 5

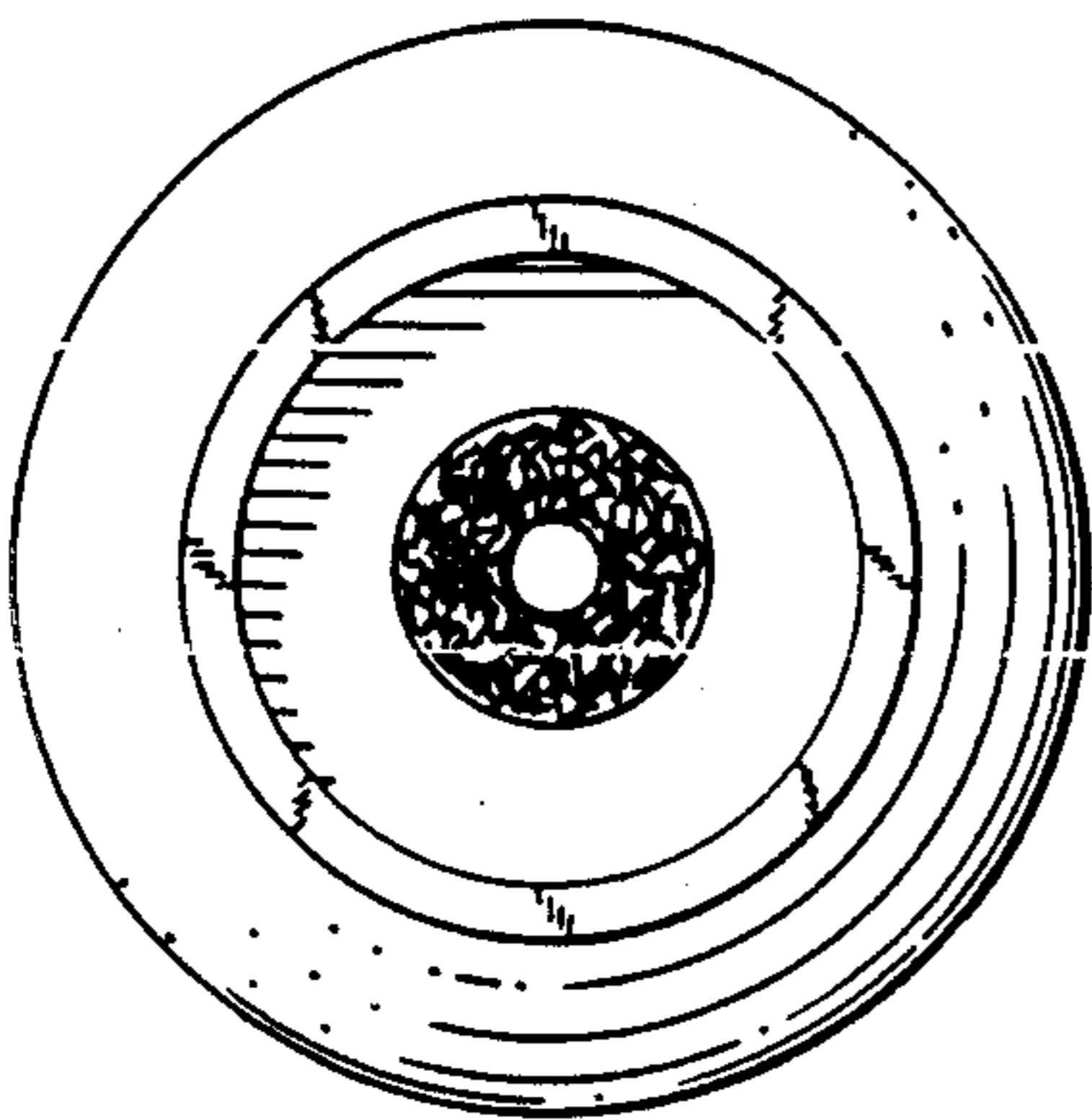

FIG. 8

