

[54] CARDHOLDER

[75] Inventor: Jeffrey Rowe, Parker, Colo.

[73] Assignee: Comtech Services, Inc., Denver, Colo.

[\*\*] Term: 14 Years

[21] Appl. No.: 154,629

[22] Filed: Feb. 10, 1988

[52] U.S. Cl. .... D19/76; D19/86; D19/90; D19/95

[58] Field of Search ..... D19/20, 27, 68, 75, D19/76, 83, 86, 90, 91, 92, 95, 99, 100; 40/371-395, 402; 211/11, 50, 72; 206/214, 425

[56] References Cited

U.S. PATENT DOCUMENTS

D. 43,708	3/1913	Weeks	.....	D19/86 X
D. 57,227	3/1921	Haupt	.....	D19/20
D. 159,472	8/1950	Cleiff	.....	D19/86 X
D. 203,568	1/1966	Tucker	.....	D19/83 X
D. 248,964	8/1978	Kizlauskas	.....	D19/76

D. 260,405	8/1981	Tarrant et al.	.....	D19/20
D. 264,979	6/1982	Goldman	.....	D19/92 X
D. 273,796	5/1984	Milden	.....	D19/27
D. 297,235	8/1988	Atwell	.....	D19/86
4,082,190	4/1978	Merz	.....	211/50 X
4,750,884	6/1988	Bourgeois et al.	.....	D19/27 X

Primary Examiner—Bruce W. Dunkins  
Assistant Examiner—Martha Thompson  
Attorney, Agent, or Firm—Sheridan, Ross & McIntosh

[57] CLAIM

The ornamental design for a cardholder, as shown and described.

DESCRIPTION

FIG. 1 is a perspective view of the cardholder showing my new design;  
FIG. 2 is a left side elevational view thereof;  
FIG. 3 is a right side elevational view thereof;  
FIG. 4 is a rear elevational view thereof;  
FIG. 5 is a front elevational view thereof;  
FIG. 6 is a top plan view thereof; and  
FIG. 7 is a bottom plan view thereof.

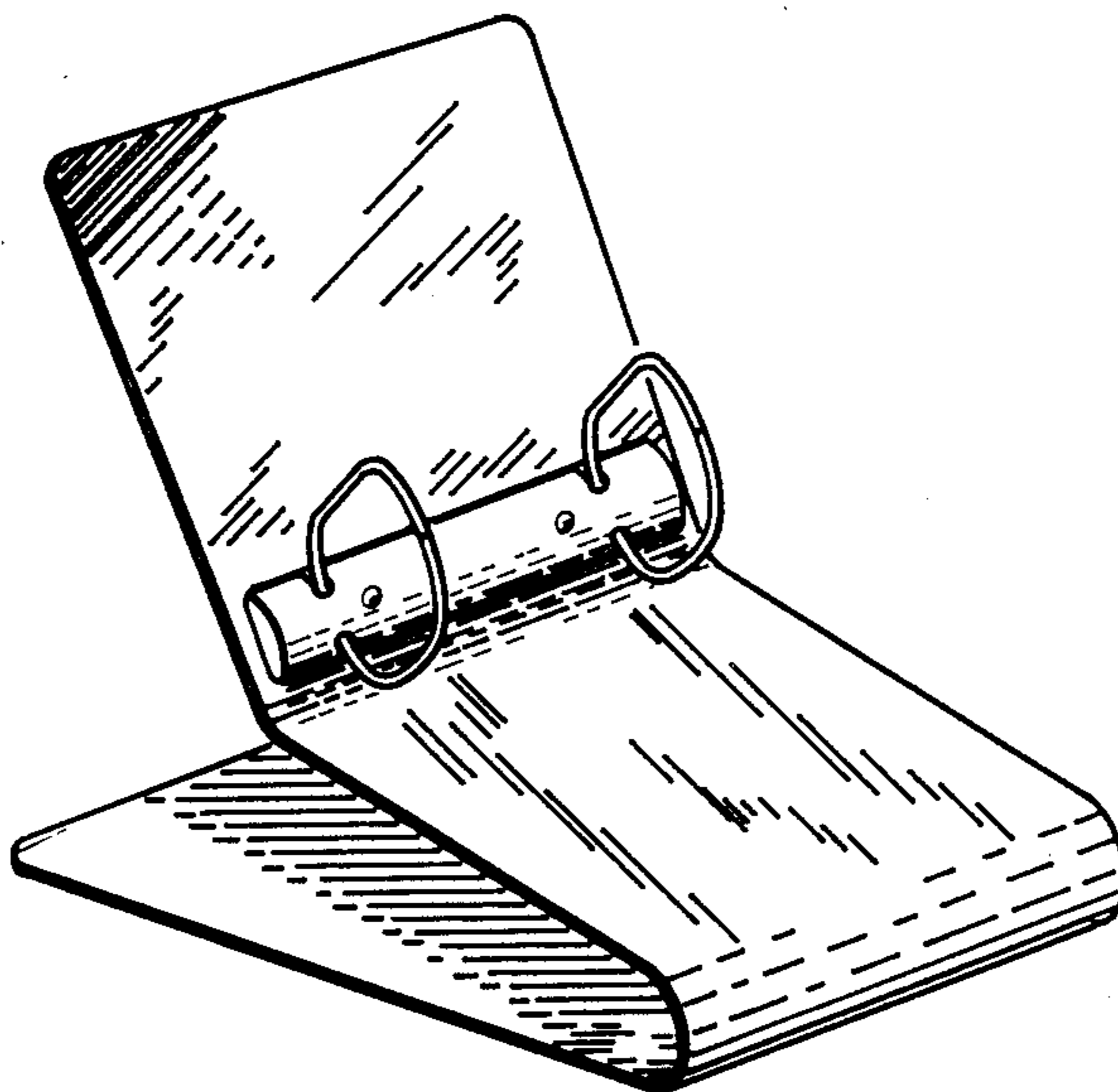

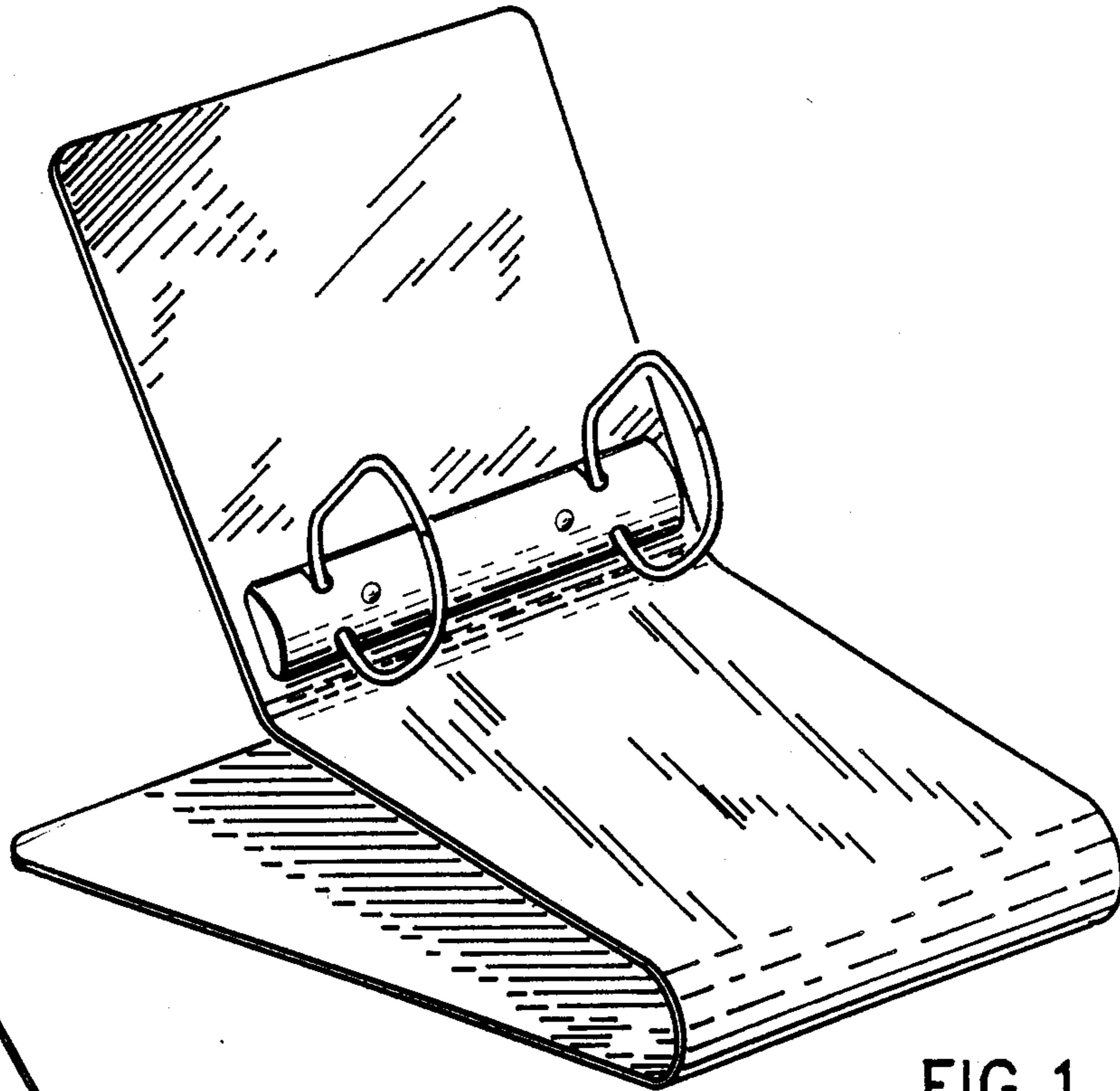

FIG. 1

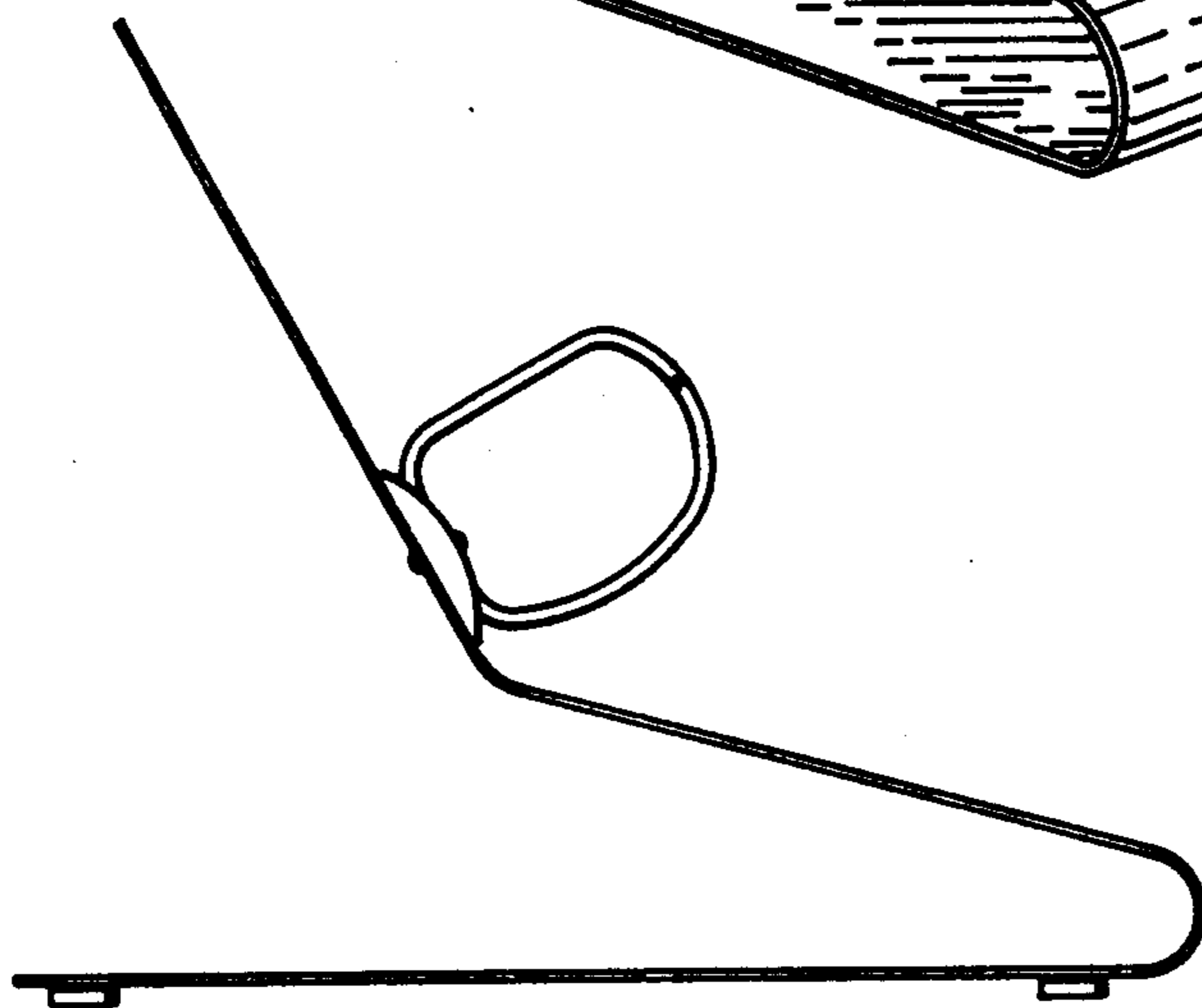

FIG. 2

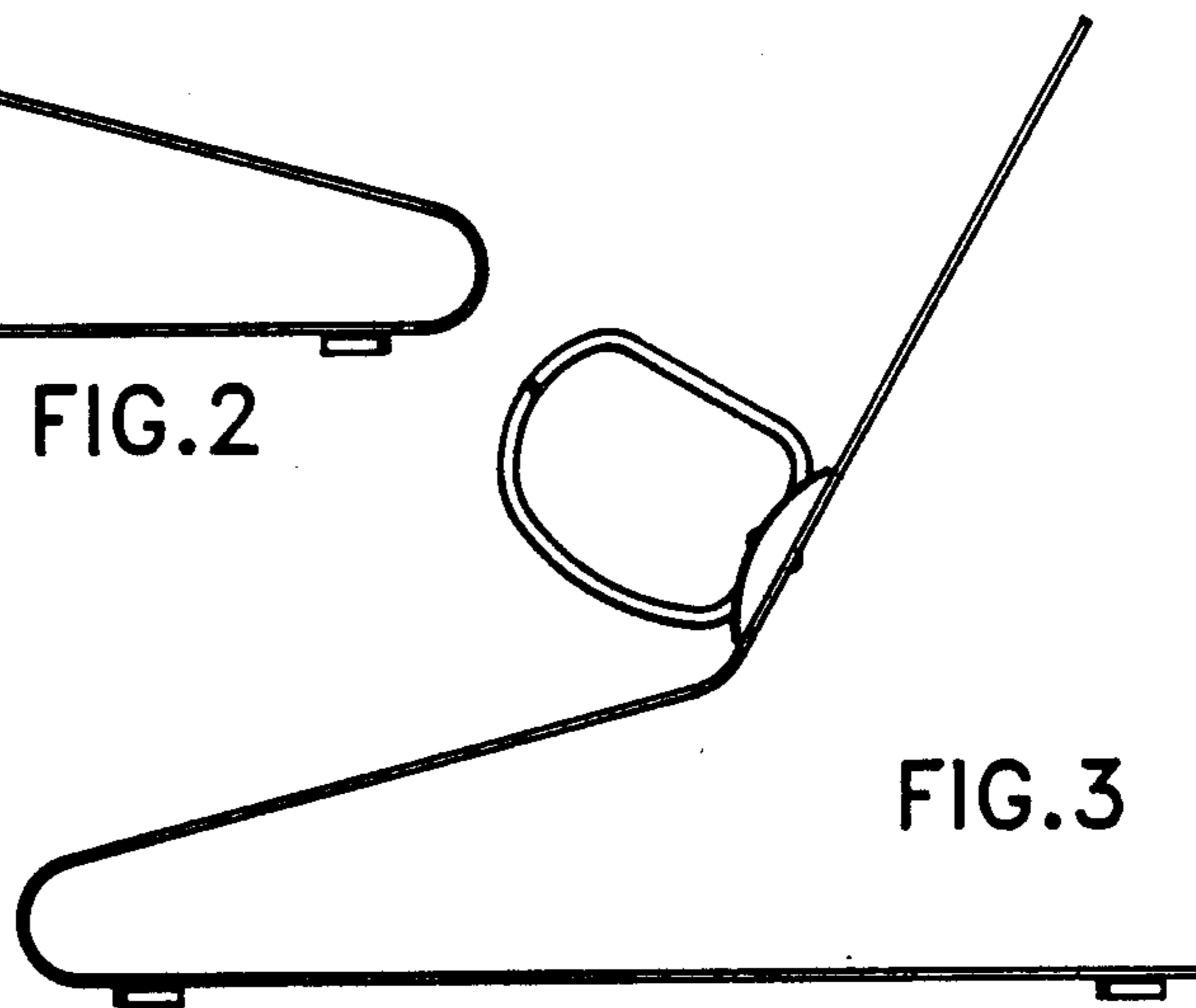

FIG. 3

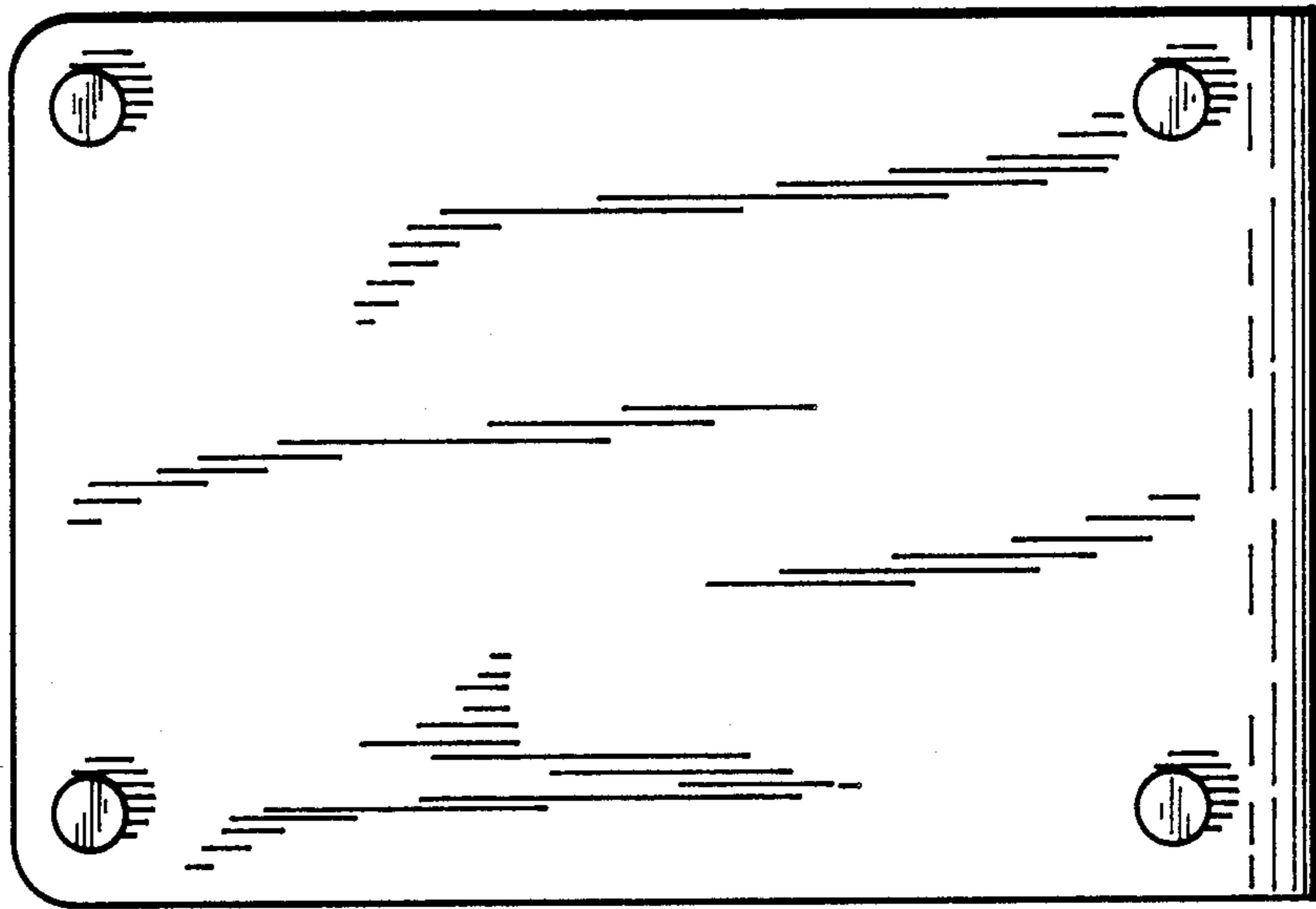

FIG. 7

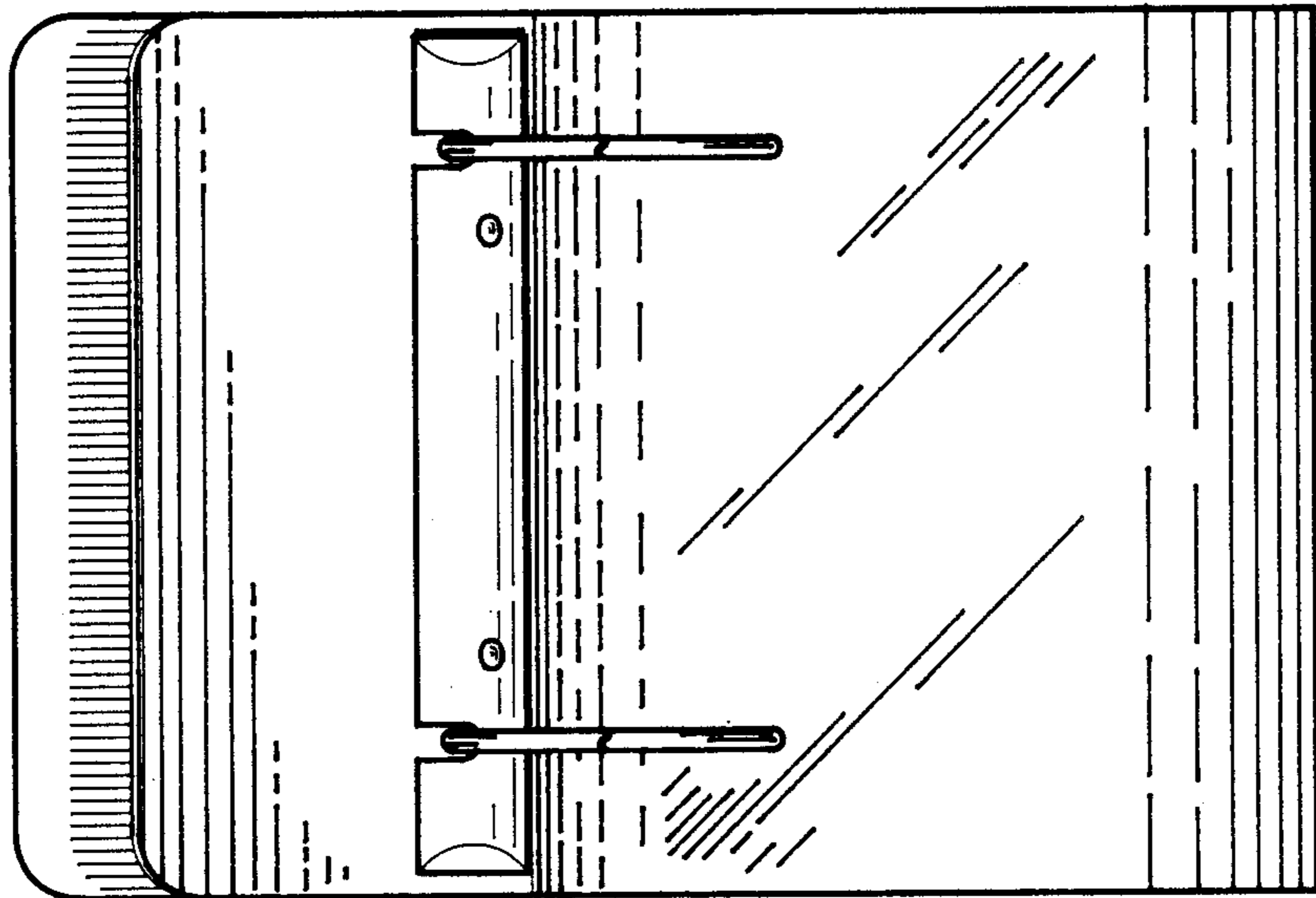

FIG. 6

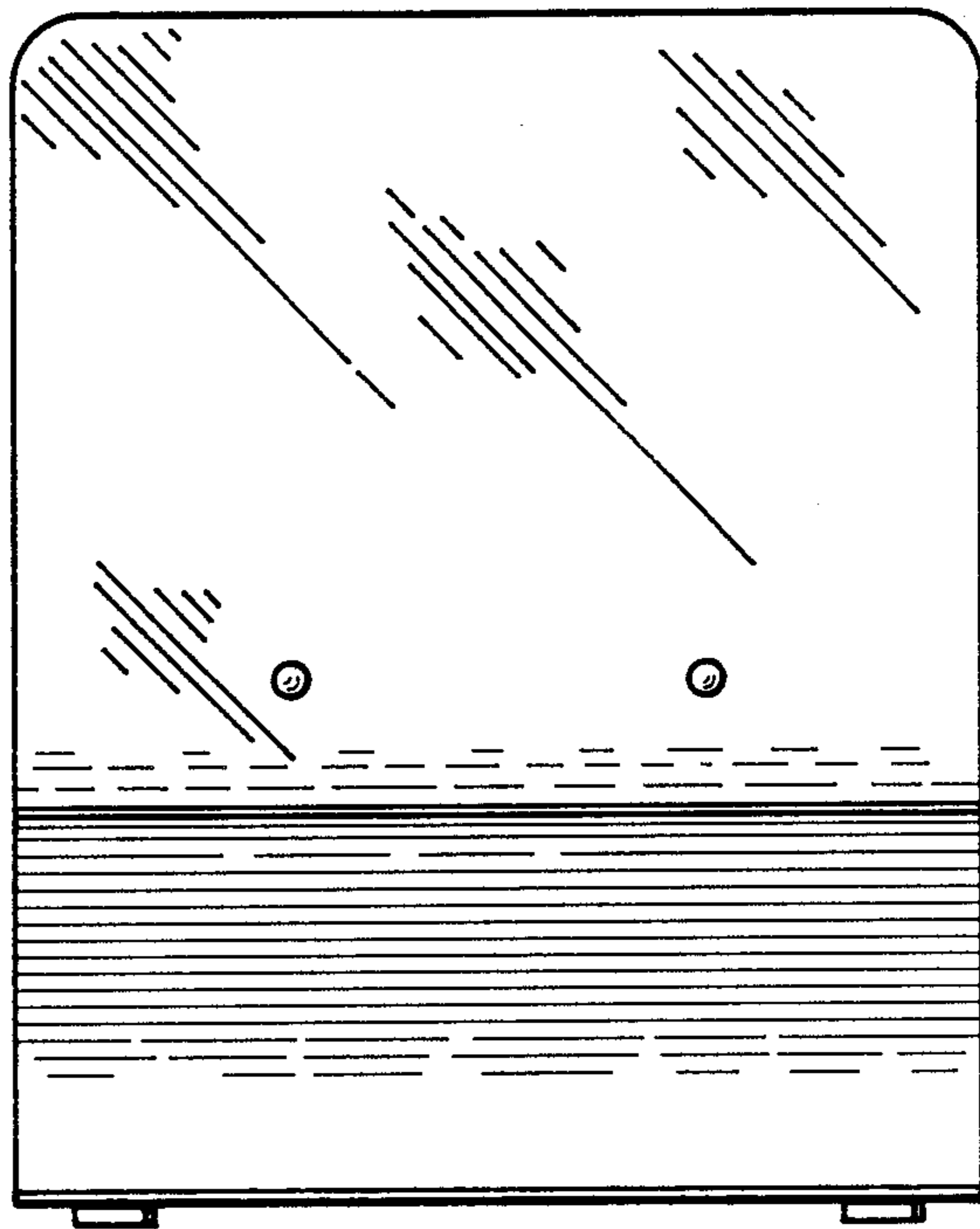

FIG. 4

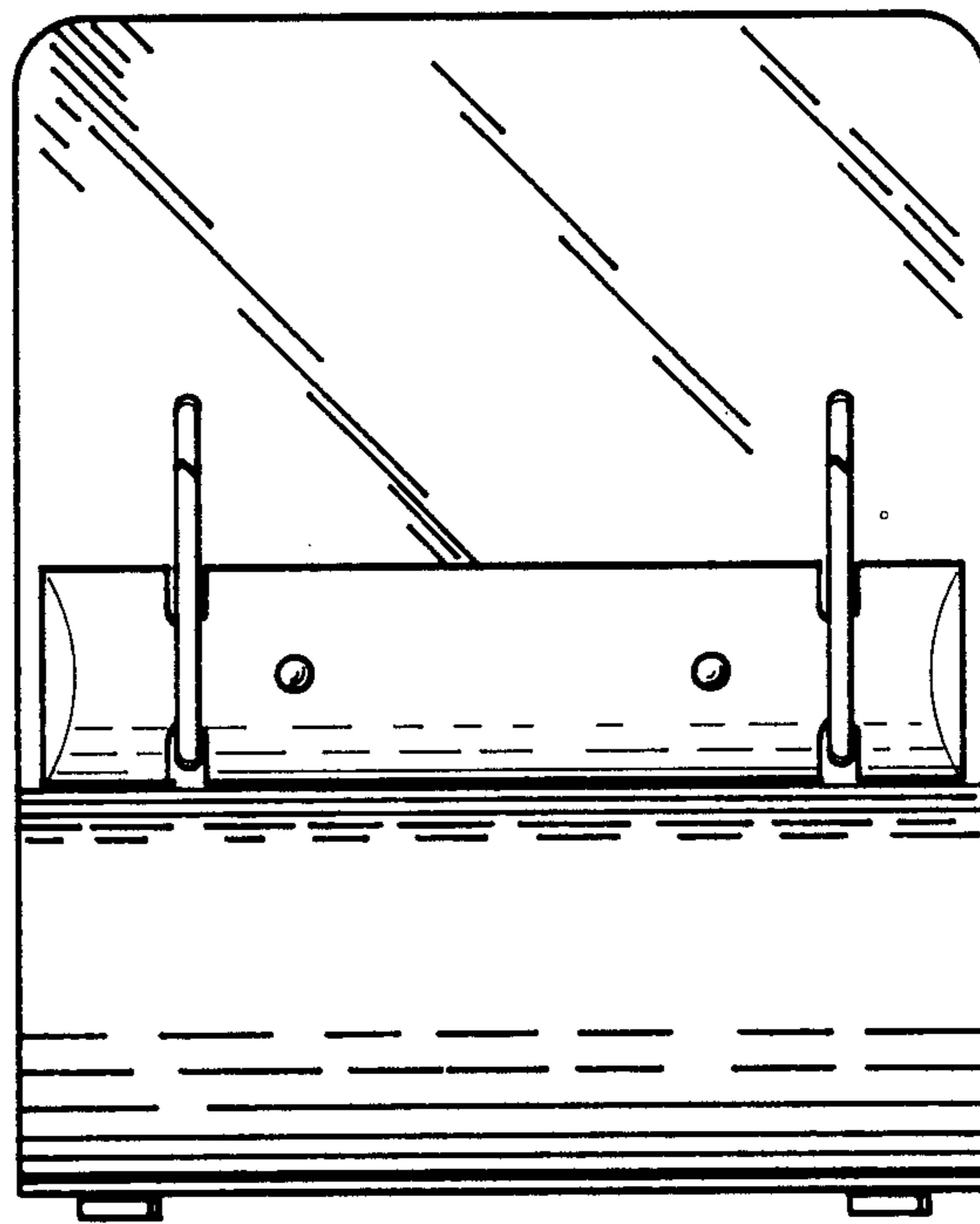

FIG. 5