

[54] FACSIMILE

[75] Inventor: Kunio Hara, Chiba, Japan

[73] Assignee: Kabushiki Kaisha Toshiba, Kawasaki, Japan

[**] Term: 14 Years

[21] Appl. No.: 149,693

[22] Filed: Jan. 28, 1988

[30] Foreign Application Priority Data

Jul. 31, 1987 [JP] Japan 62-30905
 [52] U.S. Cl. D14/118
 [58] Field of Search D14/118, 141, 248;
 D18/36, 37; 358/400, 401

[56] References Cited

U.S. PATENT DOCUMENTS

D. 300,139 3/1989 Nishio D14/118
 D. 302,156 7/1989 Takahashi et al. D14/248 X
 D. 304,183 10/1989 Hara et al. D14/118
 D. 304,579 11/1989 Fujiyama et al. D14/118
 D. 305,425 1/1990 Hara et al. D14/118

OTHER PUBLICATIONS

Catalog of Panafax UF-10 (Matsushita Electric Industrial Co., Ltd.).
 Catalog of Panafax UF-32 (Matsushita Electric Industrial Co., Ltd.).
 Catalog of Canofax 120 "On the Desk" (Canon, Inc.).
 Catalog of Canofax 110 "On the Desk" (Canon, Inc.).
 Catalog of Canofax 50 "Mighty" (Canon, Inc.).

Primary Examiner—Theodore M. Shooman
 Attorney, Agent, or Firm—Oblon, Spivak, McClelland, Maier & Neustadt

[57] CLAIM

The ornamental design for a facsimile, as shown and described.

DESCRIPTION

FIG. 1 is a top, front and right side perspective view of a facsimile showing my new design;
 FIG. 2 is a top plan view thereof;
 FIG. 3 is a front elevational view thereof;
 FIG. 4 is a rear elevational view thereof;
 FIG. 5 is a left side elevational view thereof;
 FIG. 6 is a right side elevational view thereof;
 FIG. 7 is a top plan view thereof, with the sheet support in a raised position and the hand set inverted; and
 FIG. 8 is an enlarged fragmentary top and left side perspective view thereof, with the hand set inverted.

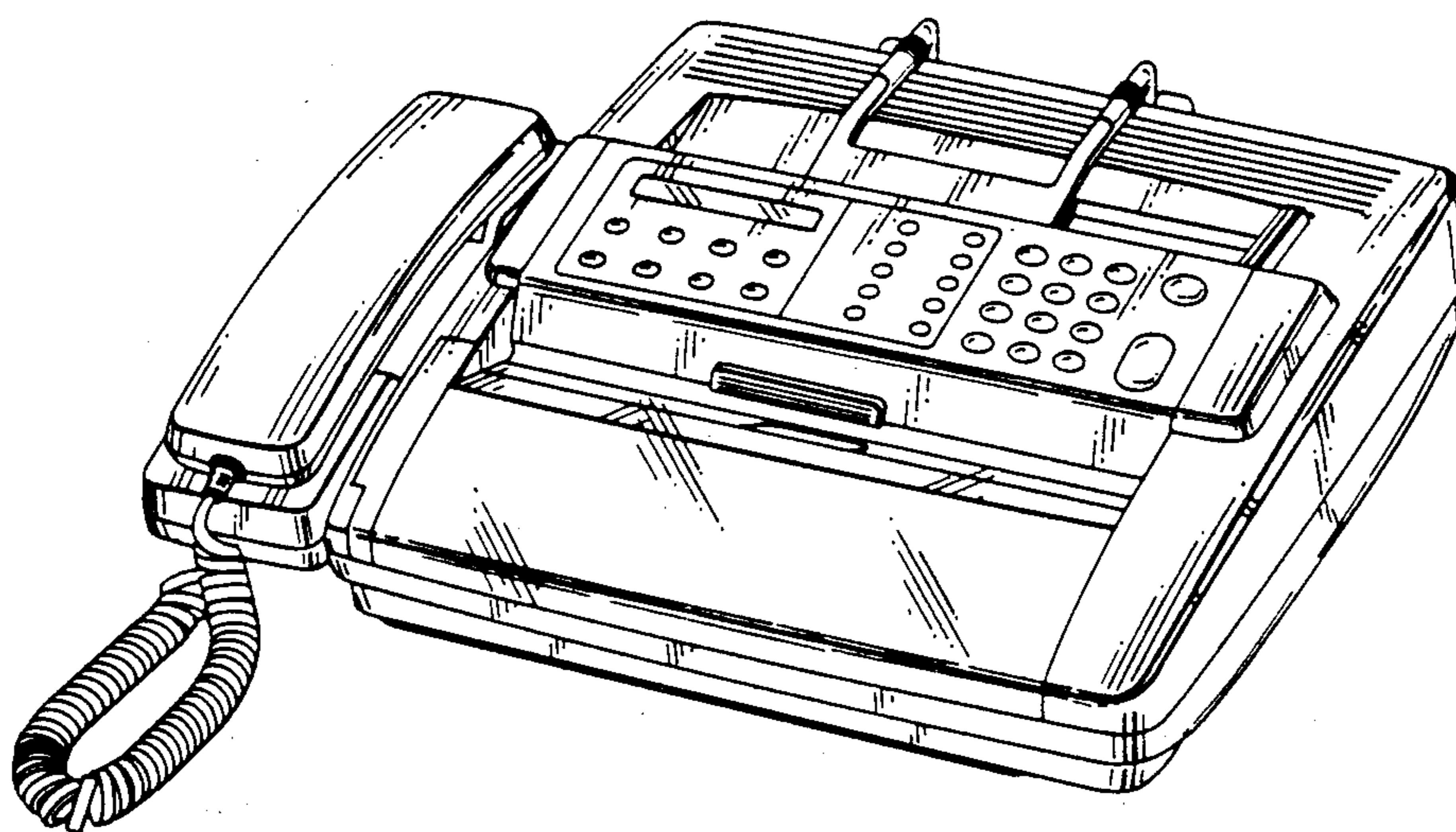

FIG. 1

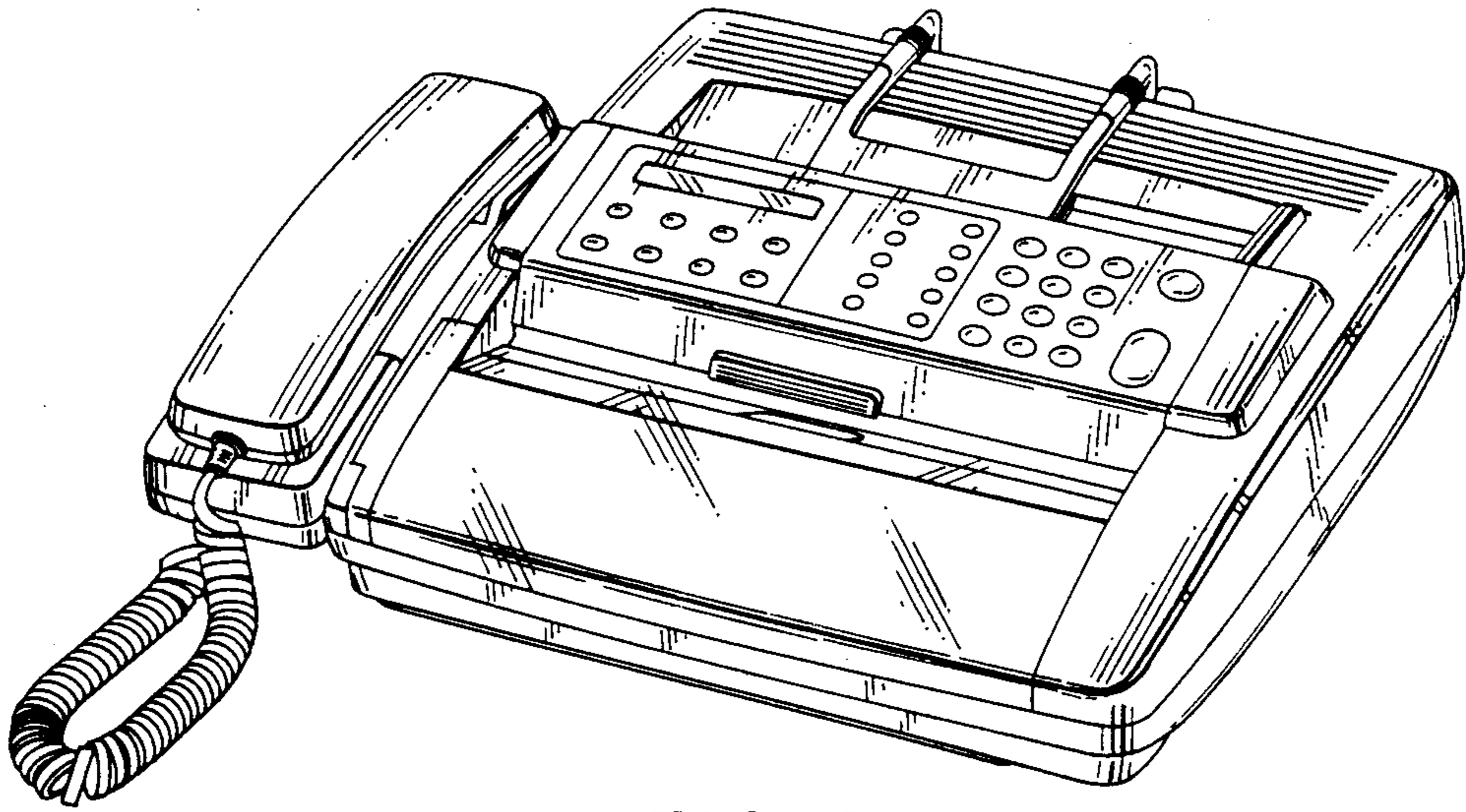

FIG. 2

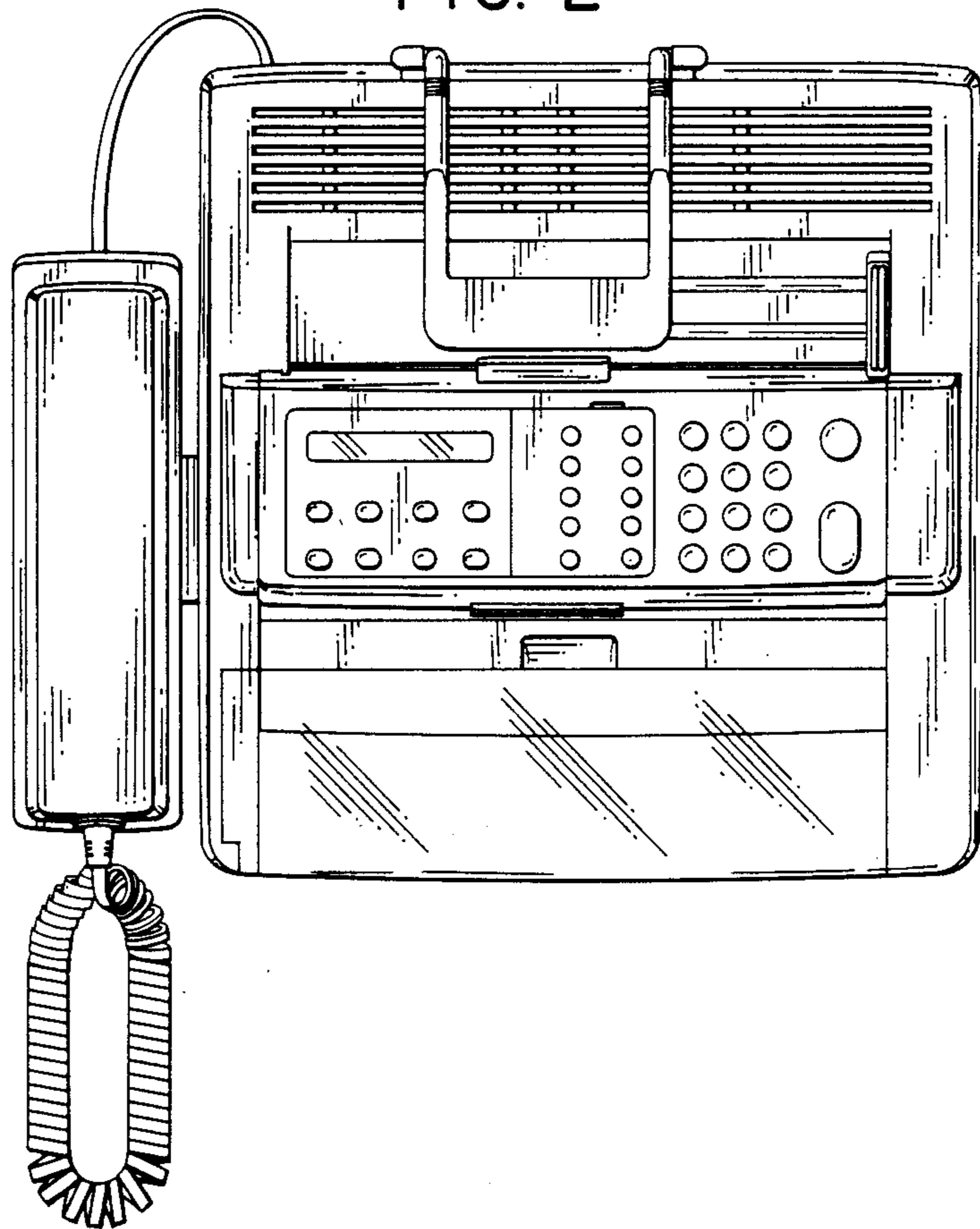

FIG. 3

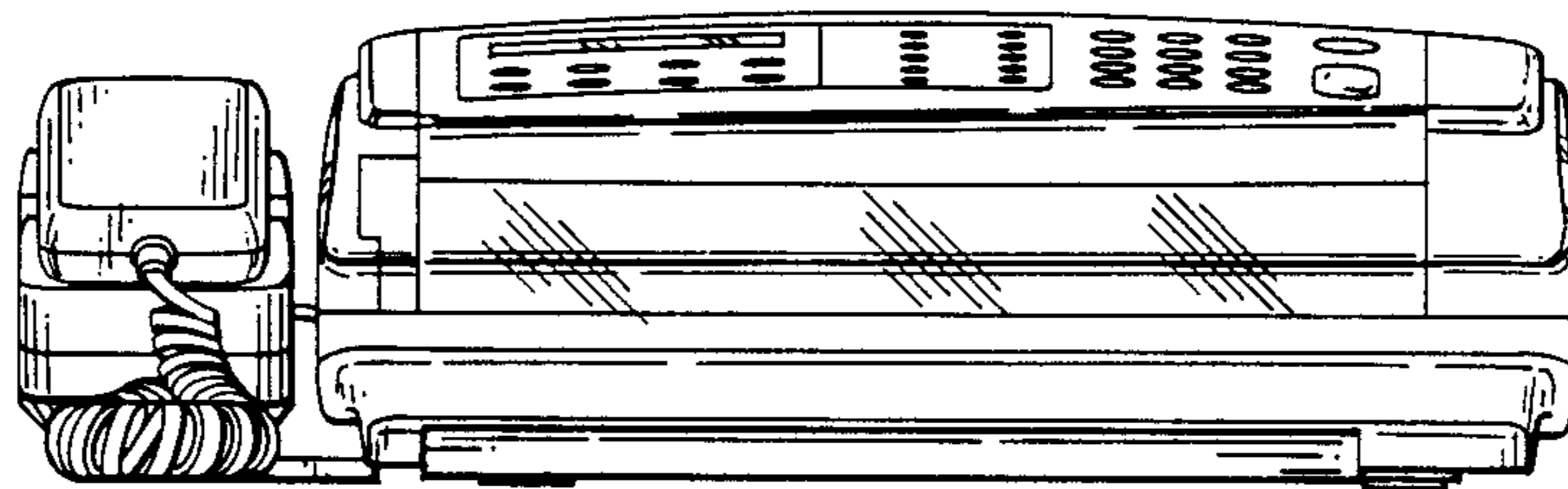

FIG. 4

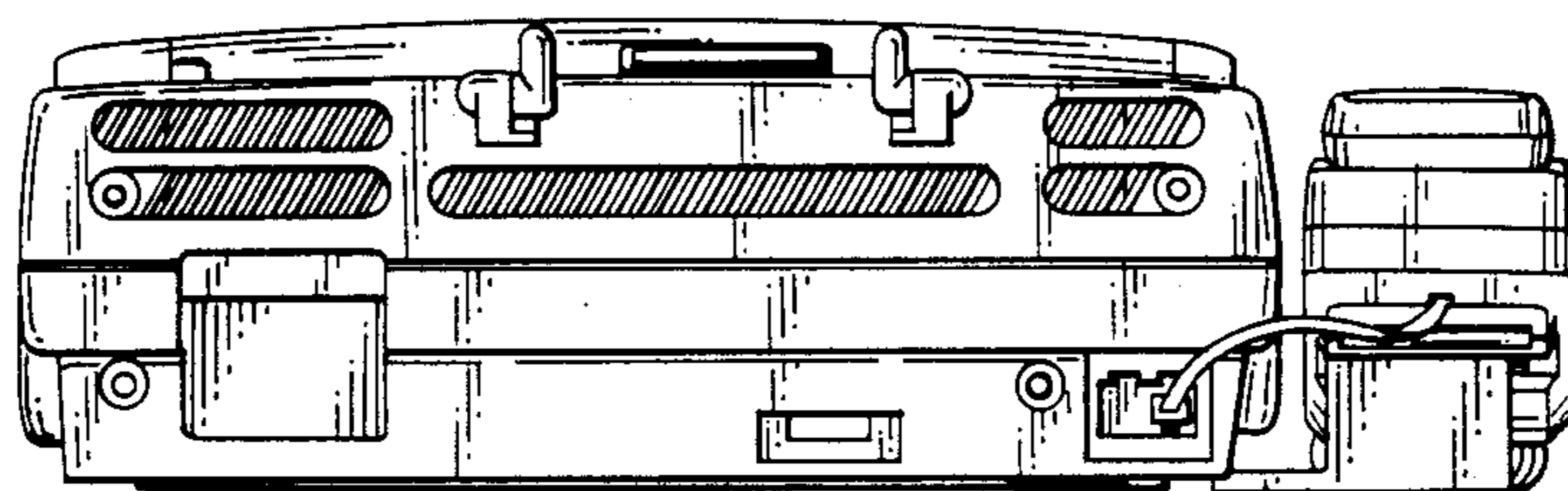

FIG. 5

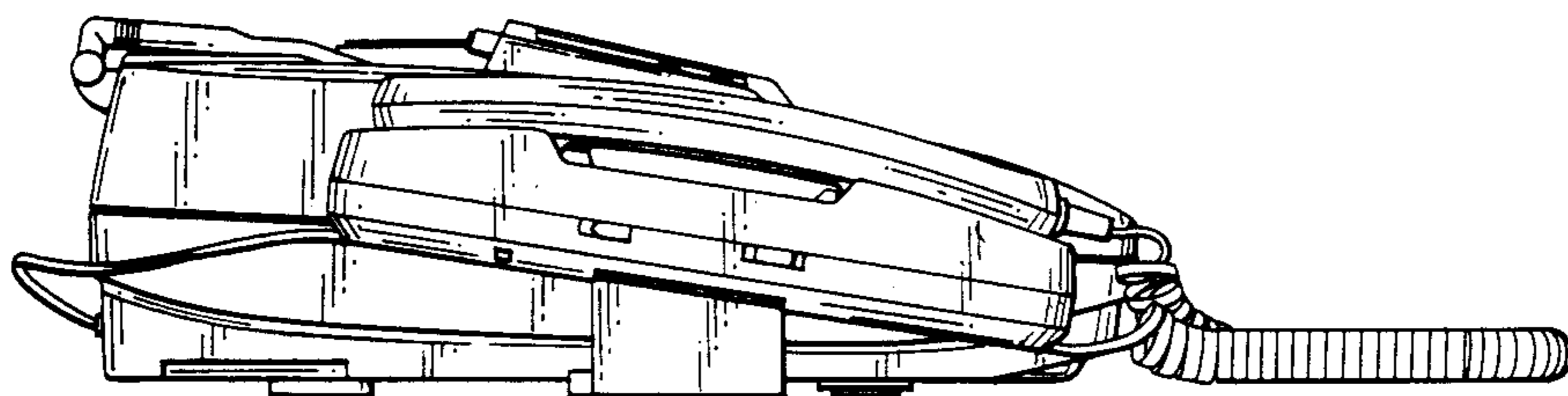

FIG. 6

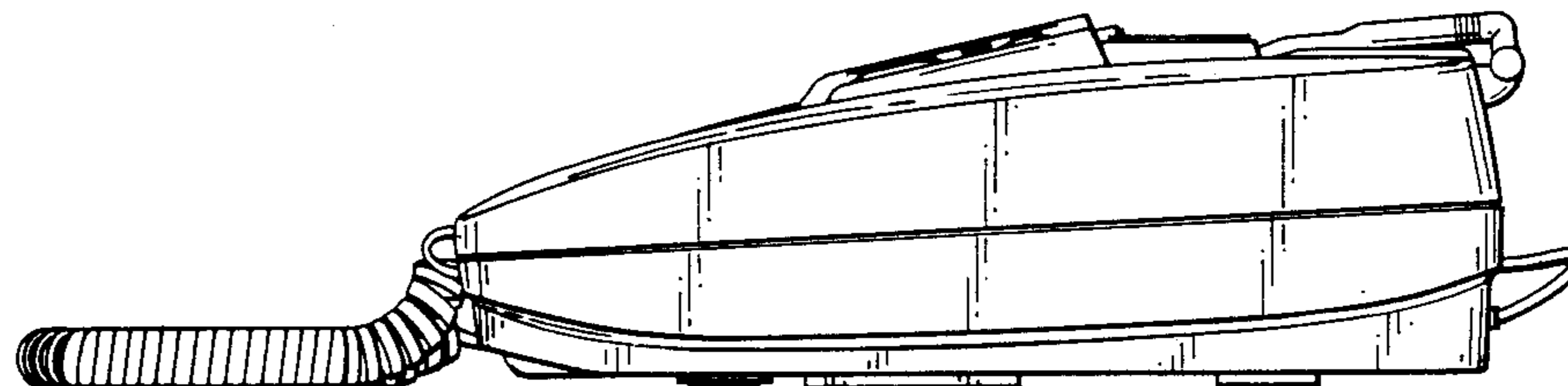

FIG. 7

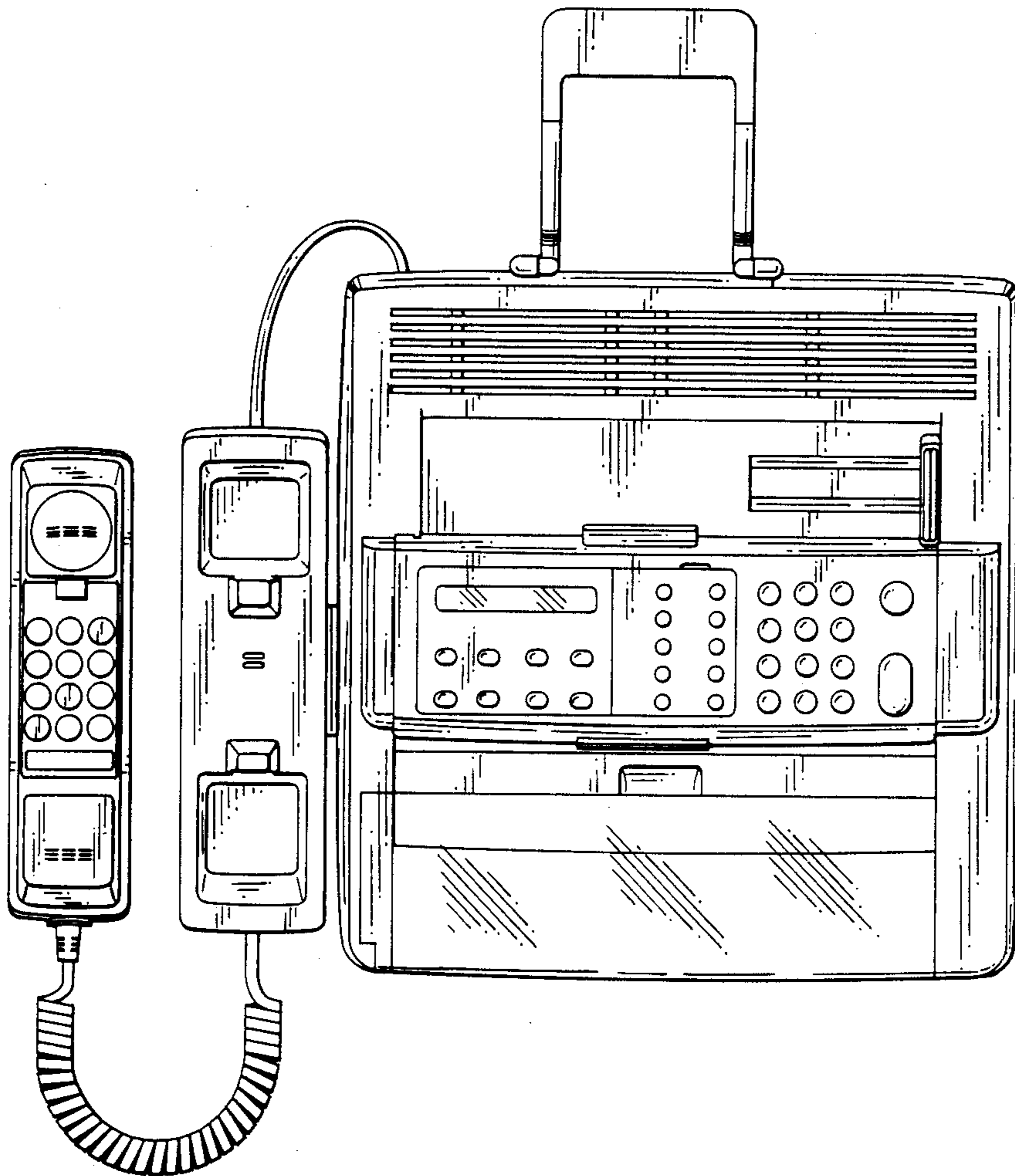

FIG. 8

