

[54] FOLDED PAPER TOWEL DISPENSER

[75] Inventors: John A. Richter, Cincinnati, Ohio; Benito J. Hermann, Jr., Charlotte, N.C.

[73] Assignee: Serendee, Inc., Cincinnati, Ohio

[**] Term: 14 Years

[21] Appl. No.: 254,127

[22] Filed: Oct. 6, 1988

[52] U.S. Cl. D6/522

[58] Field of Search D6/515, 518, 521-522; 211/13, 16, 86-87; 220/112; 221/45, 282, 197; 242/55.2, 55.53

[56] References Cited

U.S. PATENT DOCUMENTS

D. 158,207	4/1950	Lench	D6/518
D. 300,492	4/1989	Pearce	D6/518
2,472,712	6/1949	Lifschitz	242/55.5

OTHER PUBLICATIONS

House Beautiful (Feb. 1958), p. 26, "Vermont Sneeze Box".

Primary Examiner—Wallace R. Burke

Assistant Examiner—Brian N. Vinson

Attorney, Agent, or Firm—Wood, Herron & Evans

[57] CLAIM

The ornamental design for a folded paper towel dispenser, as shown and described.

DESCRIPTION

FIG. 1 is a perspective view of the folded paper towel dispenser design of my invention;
 FIG. 2 is a front elevational view thereof;
 FIG. 3 is a top plan view thereof;
 FIG. 4 is a rear elevational view thereof;
 FIG. 5 is a left side elevational view thereof, with the right side elevational view being a mirror image thereof; and
 FIG. 6 is a bottom plan view thereof.

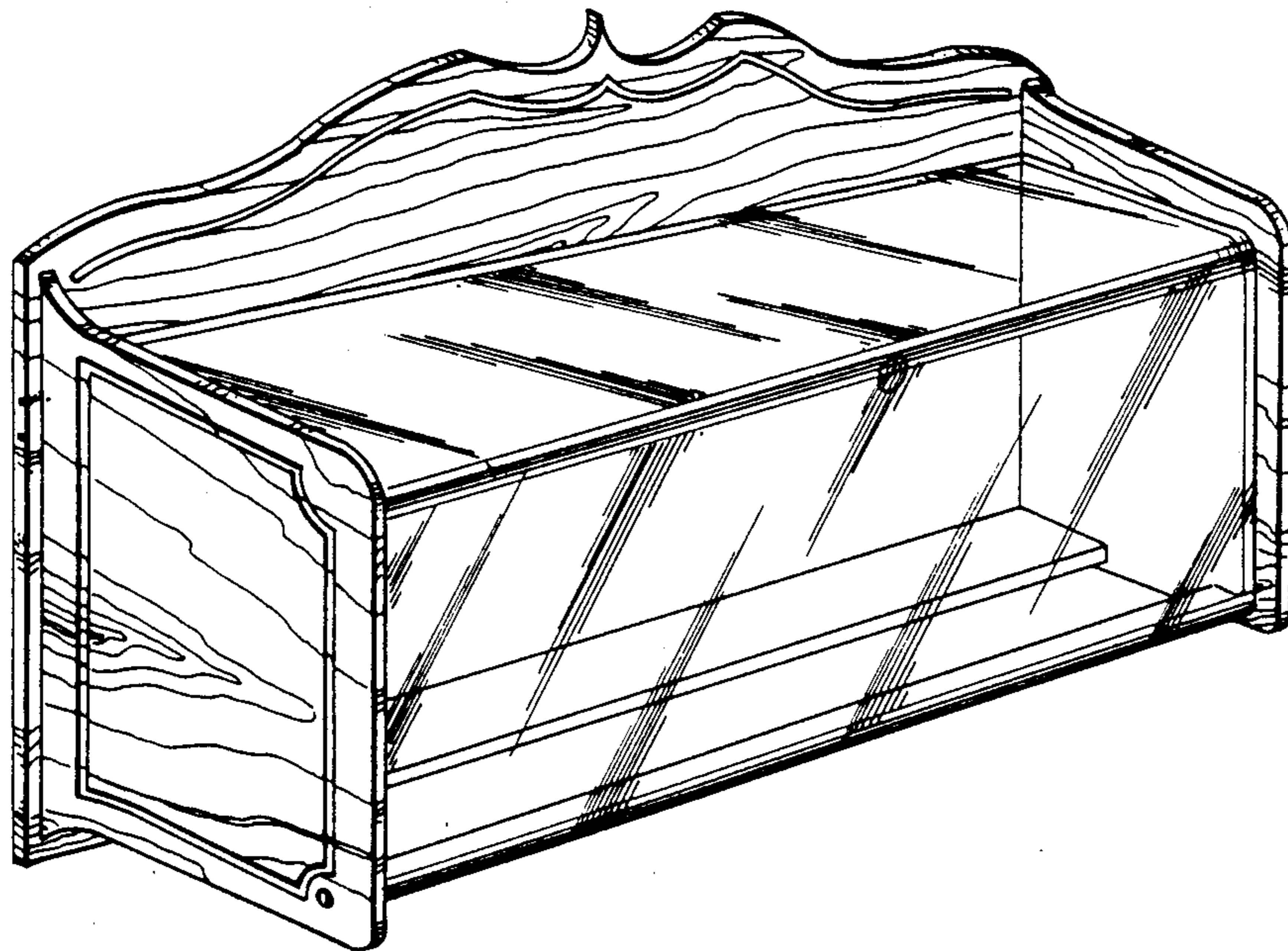

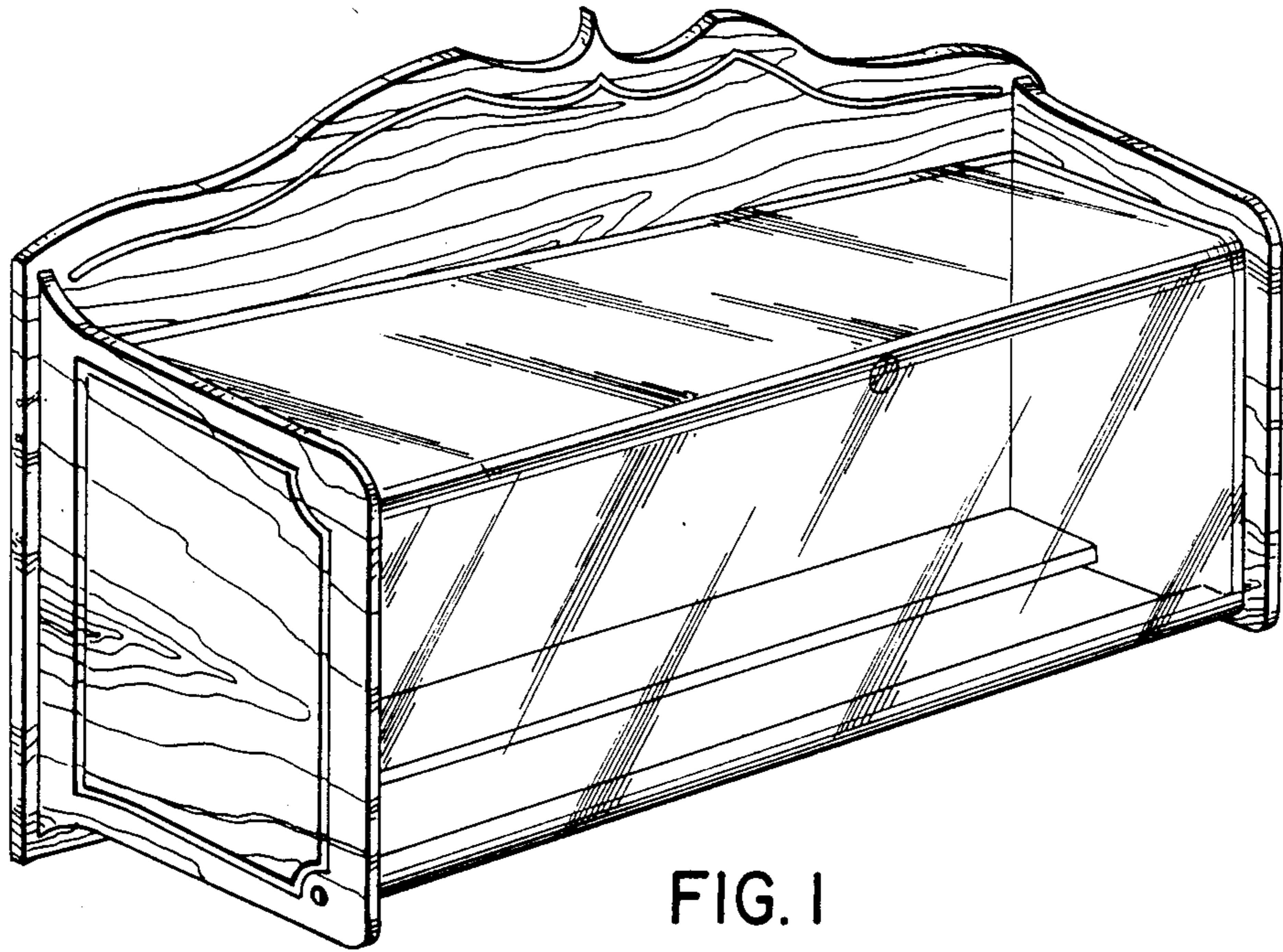

FIG. 1

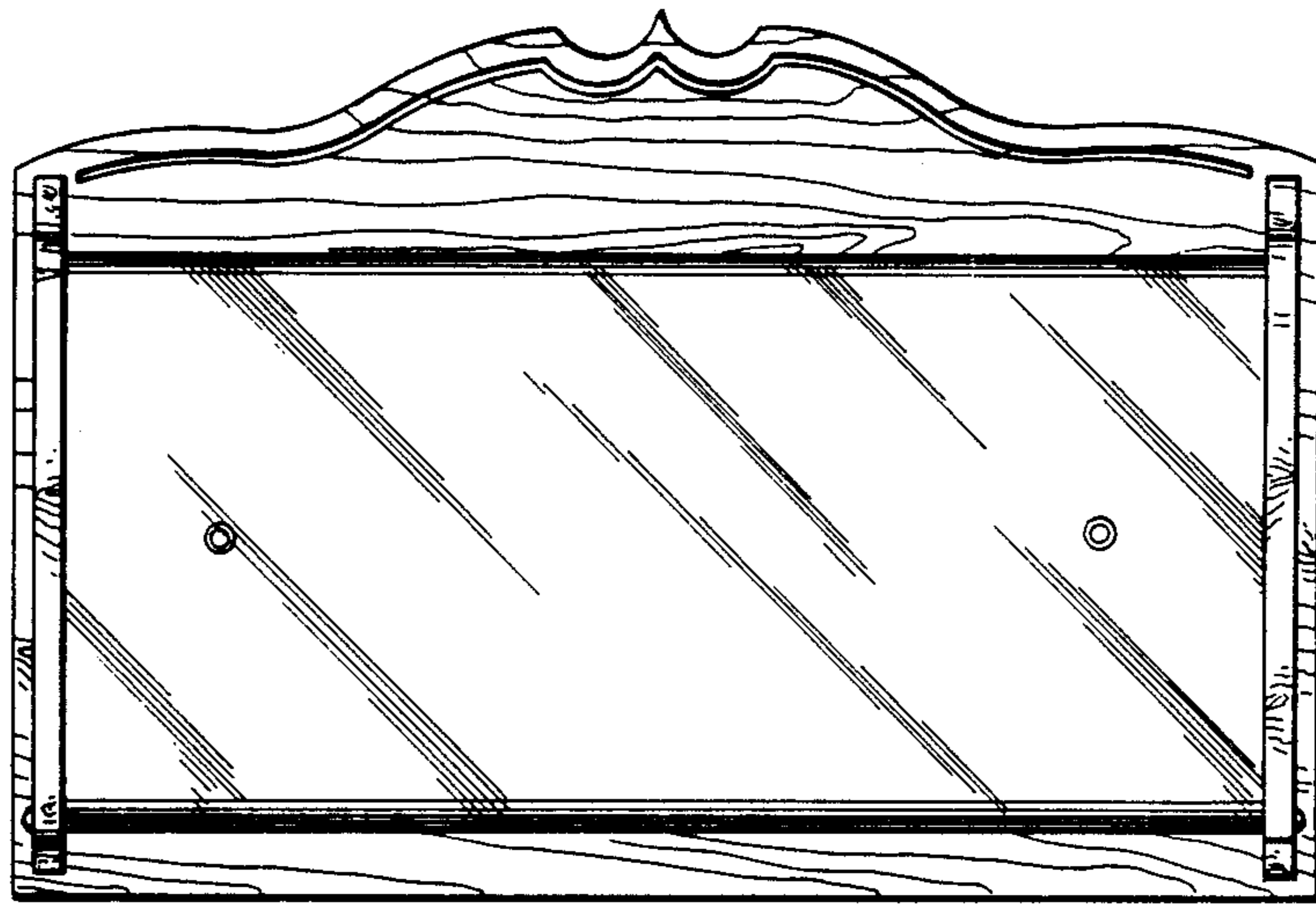

FIG. 2

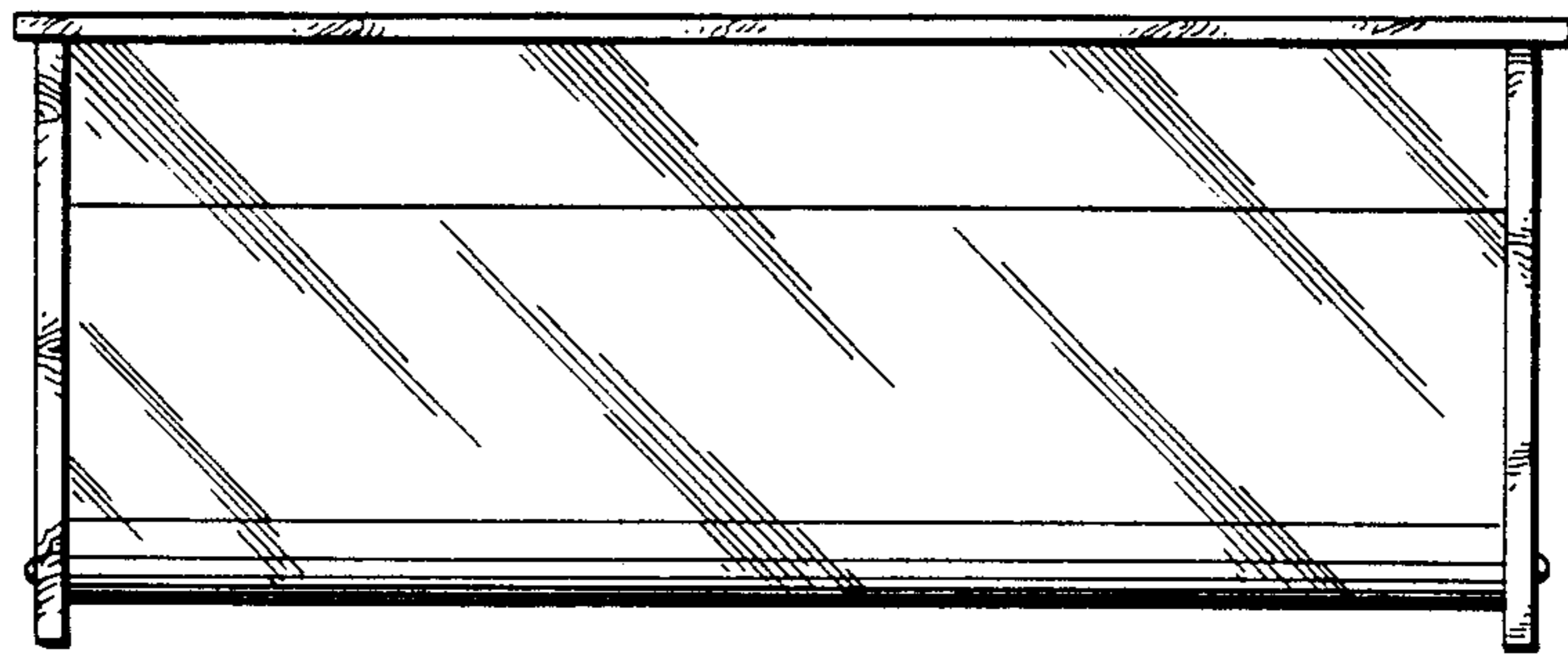

FIG. 3

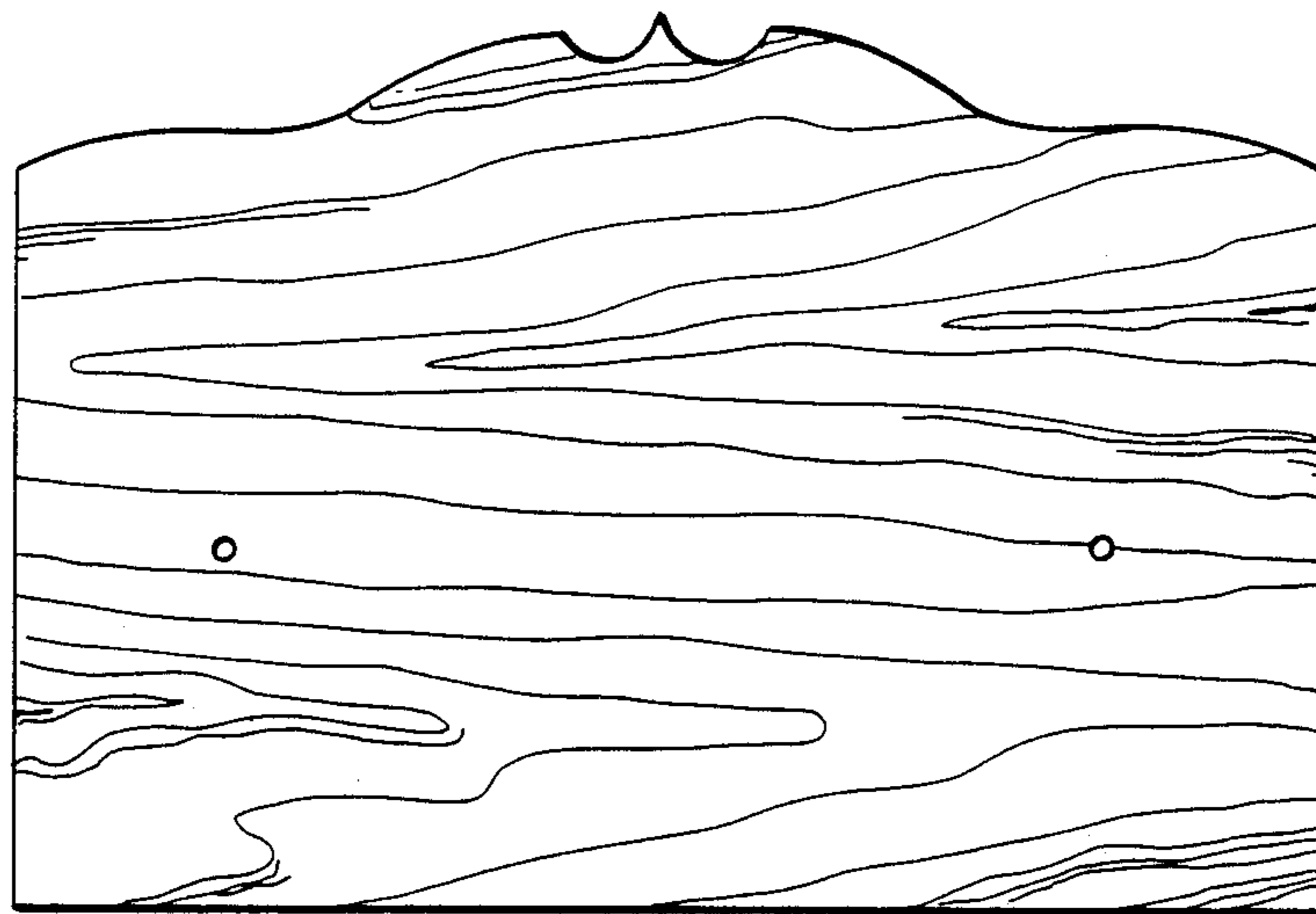

FIG. 4

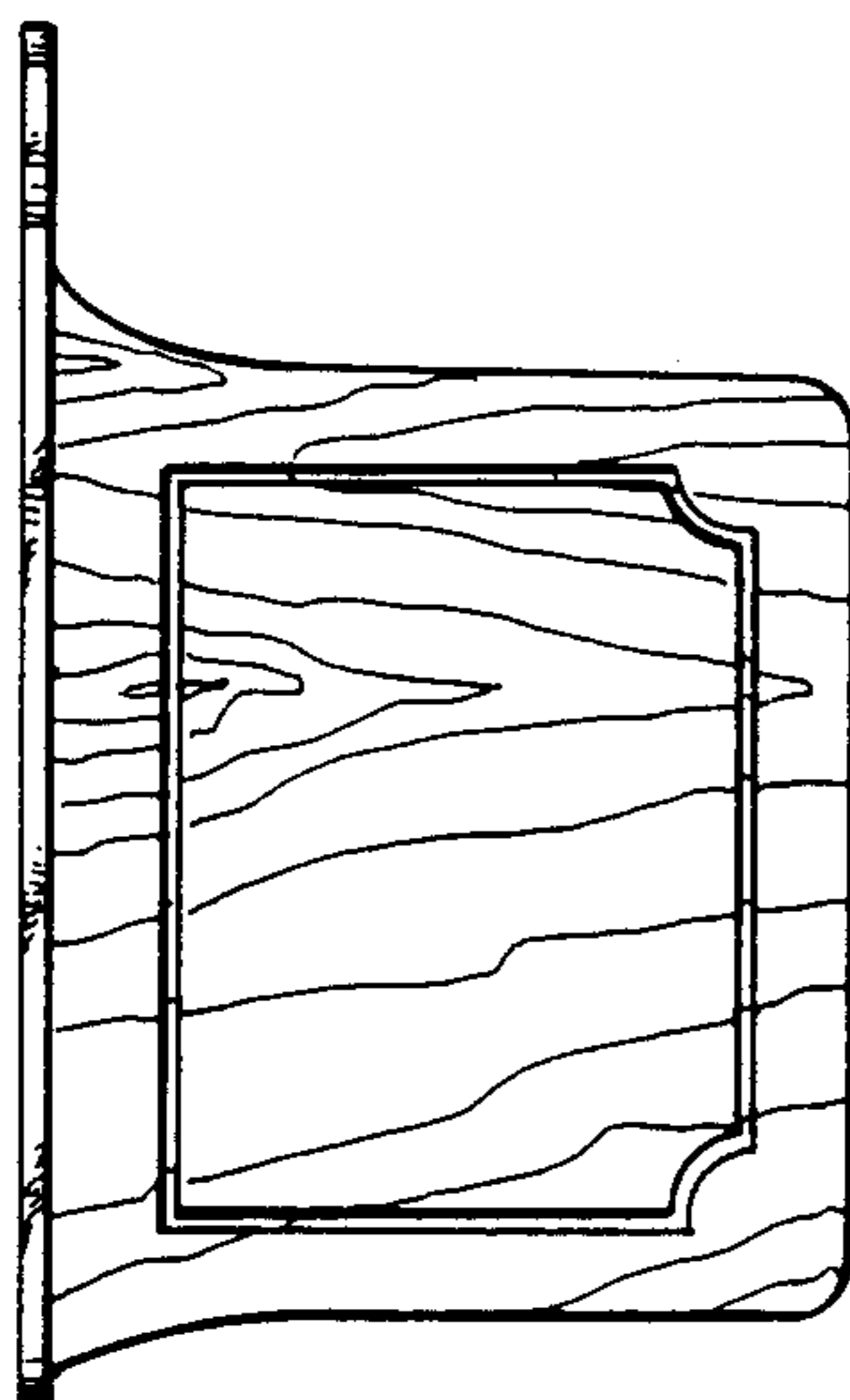

FIG. 5

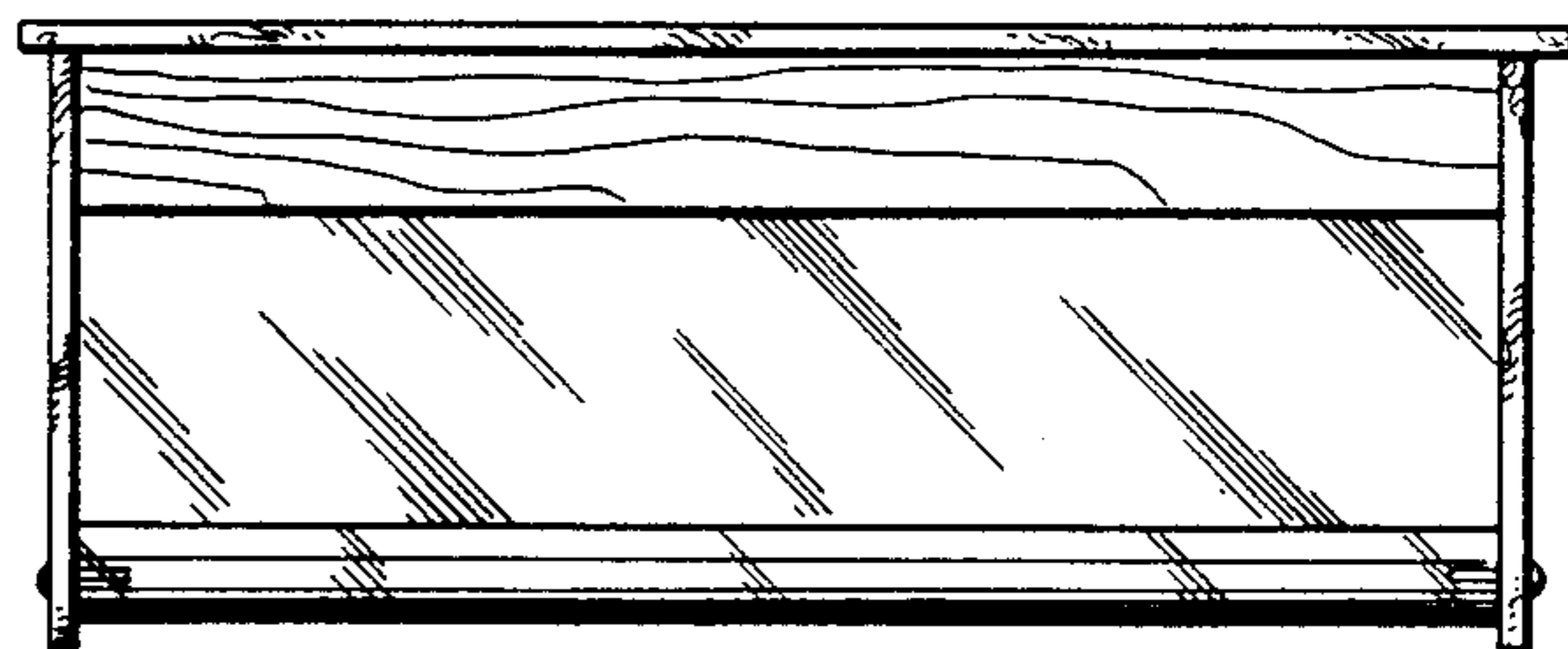

FIG. 6