

[54] BENCH

[75] Inventor: Peter M. Yau Kee, Happy Valley, Hong Kong

[73] Assignee: Rosalco, Inc., Louisville, Ky.

[\*] Notice: The portion of the term of this patent subsequent to Jul. 10, 2004 has been disclaimed.

[\*\*] Term: 14 Years

[21] Appl. No.: 428,659

[22] Filed: Oct. 30, 1989

Related U.S. Application Data

[62] Division of Ser. No. 295,566, Jan. 10, 1989.

[52] U.S. Cl. .... D6/355

[58] Field of Search ..... D6/355, 503, 505, 507, D6/508, 499, 393, 394, 395, 382, 380, 334, 374, 379, 370, 349; 211/182

[56] References Cited

U.S. PATENT DOCUMENTS

D. 49,154	6/1916	Martin	.....	D6/355
D. 73,211	8/1927	Shapiro	.....	D6/355
D. 87,577	8/1932	Hoey	.....	D6/355
D. 145,541	9/1946	Sky	.....	D6/355

OTHER PUBLICATIONS

Best Catalog, 1986/87, #2 and #7, p. 216.  
Ficks Reed Catalog, #5791, p. 40.  
Furniture/Today, Jul. 11, 1988, 2nd from right.

Primary Examiner—Bruce W. Dunkins  
Assistant Examiner—Jeffrey Asch  
Attorney, Agent, or Firm—Rhodes, Coats & Bennett

[57] CLAIM

The ornamental design for a bench, as shown and described.

DESCRIPTION

FIG. 1 is a front perspective view of a bench showing my new design;

FIG. 2 is a rear perspective view of the bench of FIG. 1;

FIG. 3 is a front elevational view of the bench of FIG. 1;

FIG. 4 is a front perspective view of a second embodiment of the bench of FIG. 1;

FIG. 5 is a front perspective view of a third embodiment of the bench of FIG. 1;

FIG. 6 is a side elevational view of the bench of FIG. 5 on an enlarged scale, the opposite side being a mirror image thereof; and

FIG. 7 is a rear elevational view of the bench of FIG. 5.

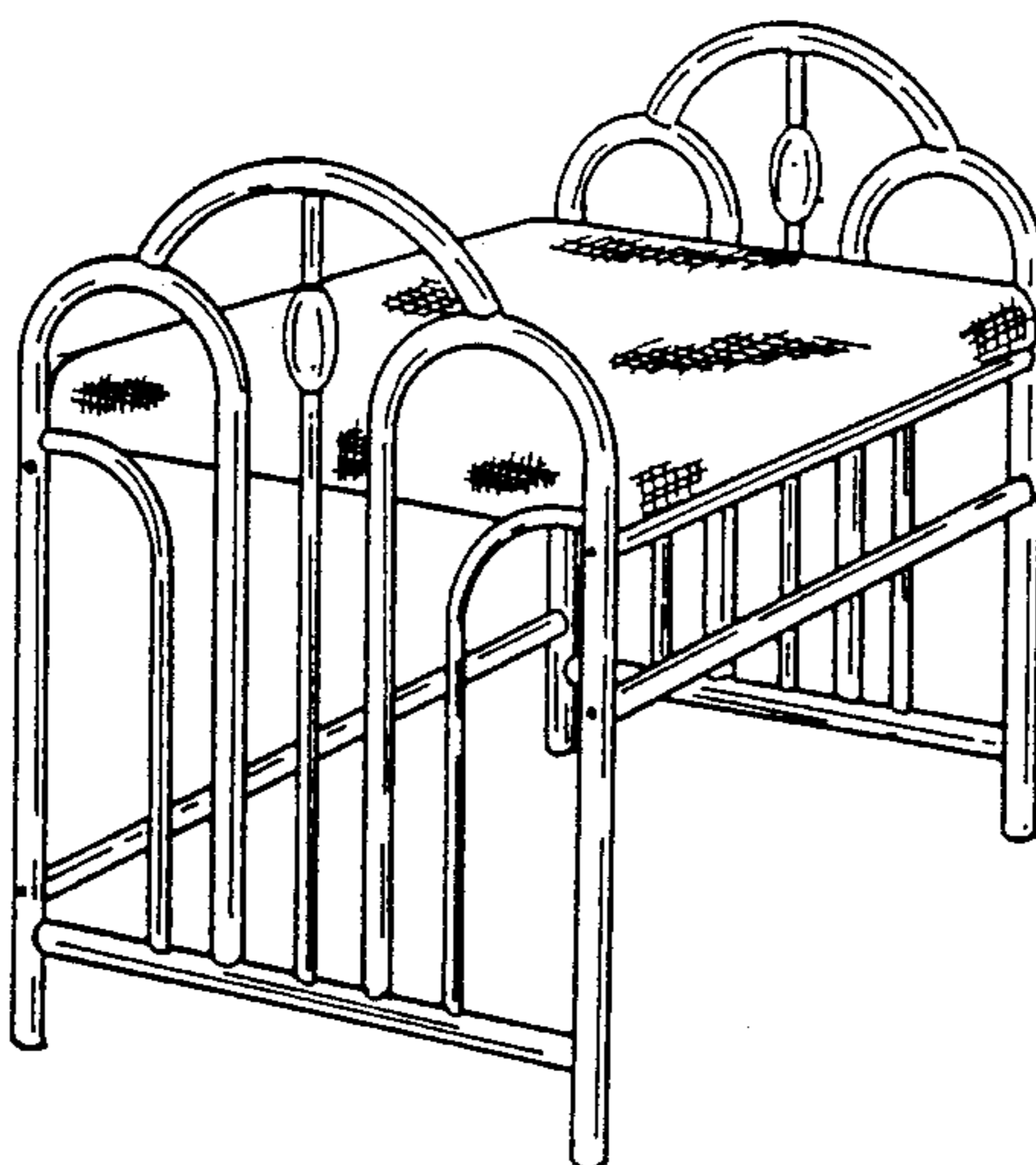

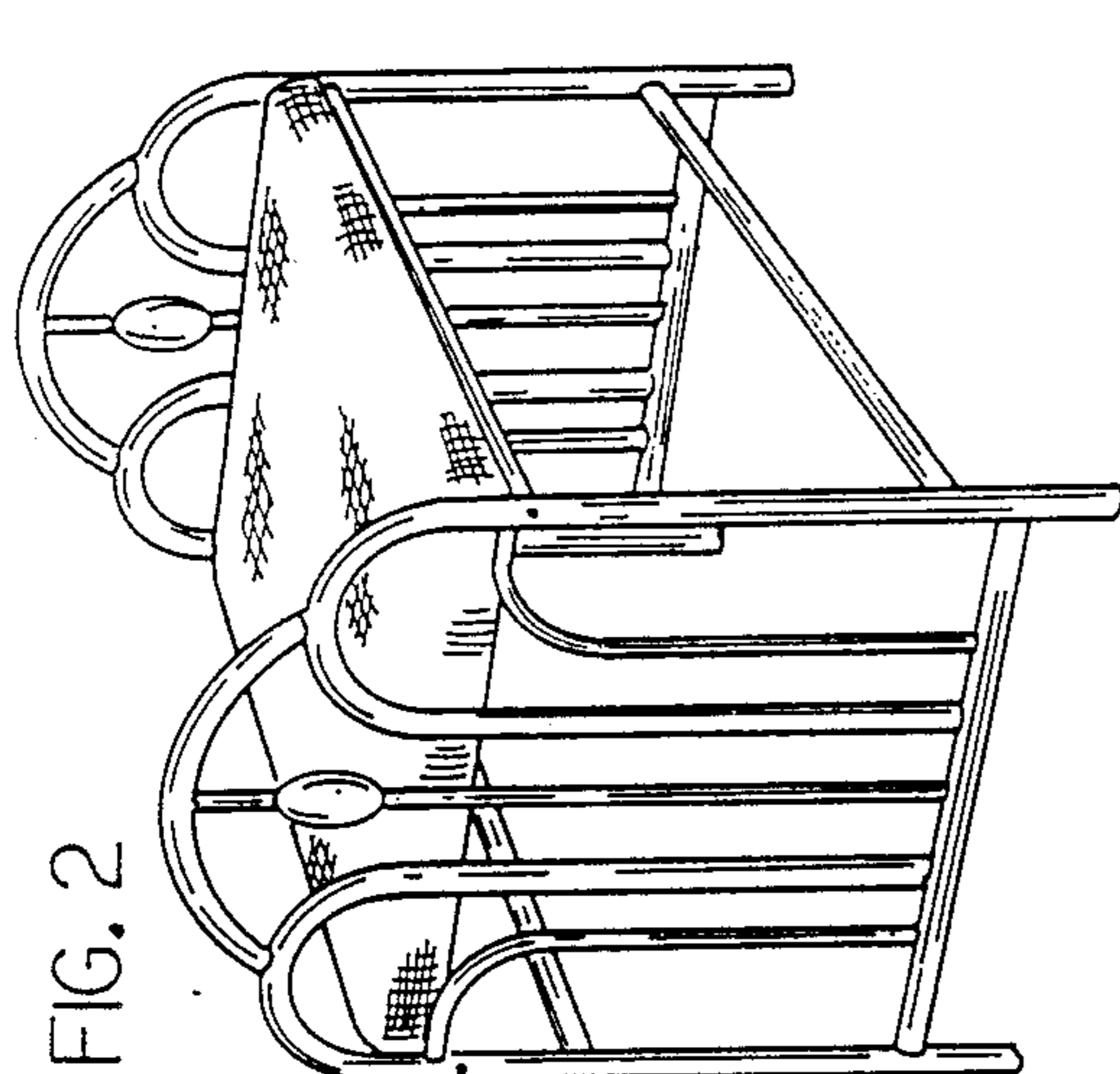

FIG. 2

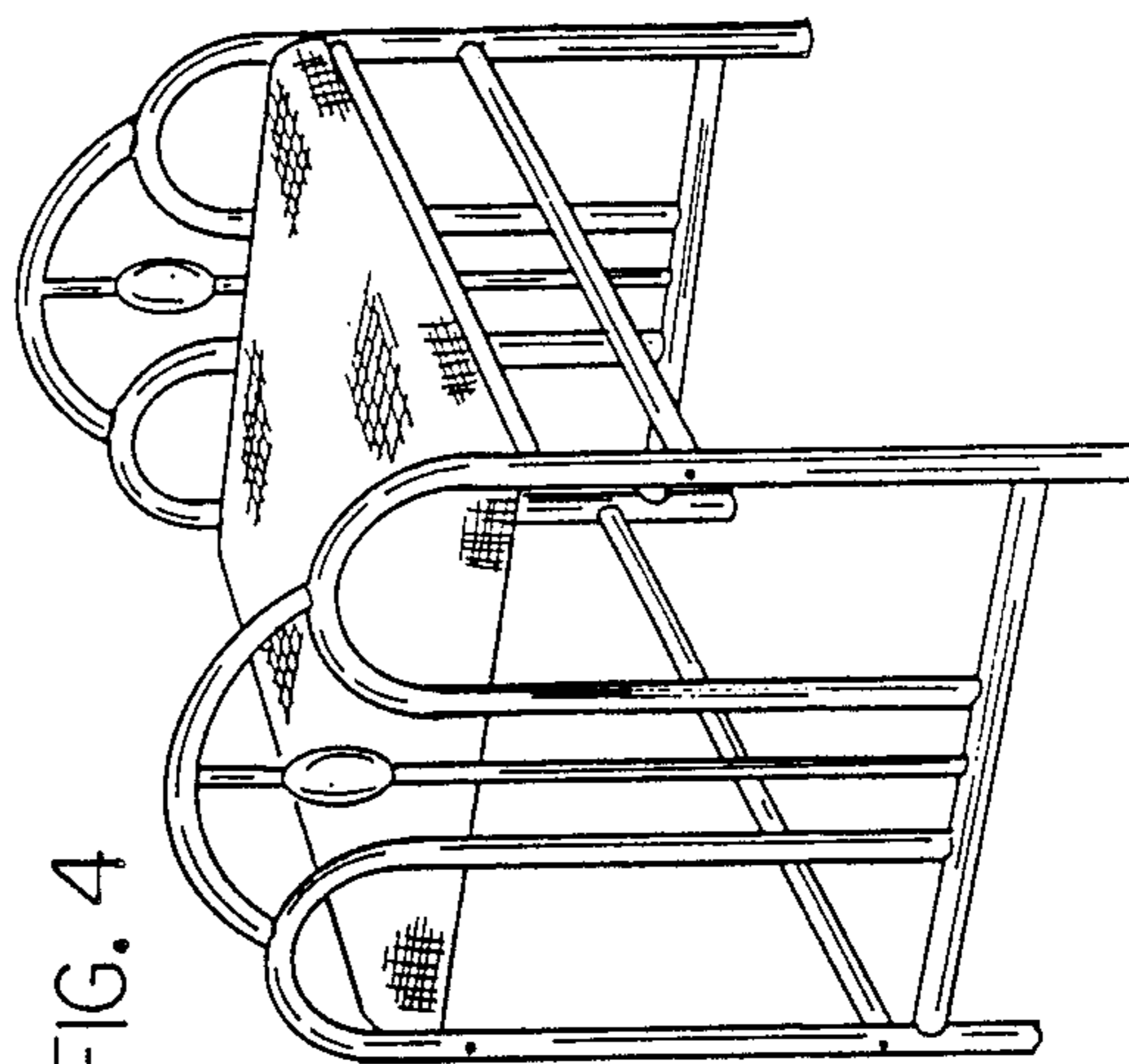

FIG. 4

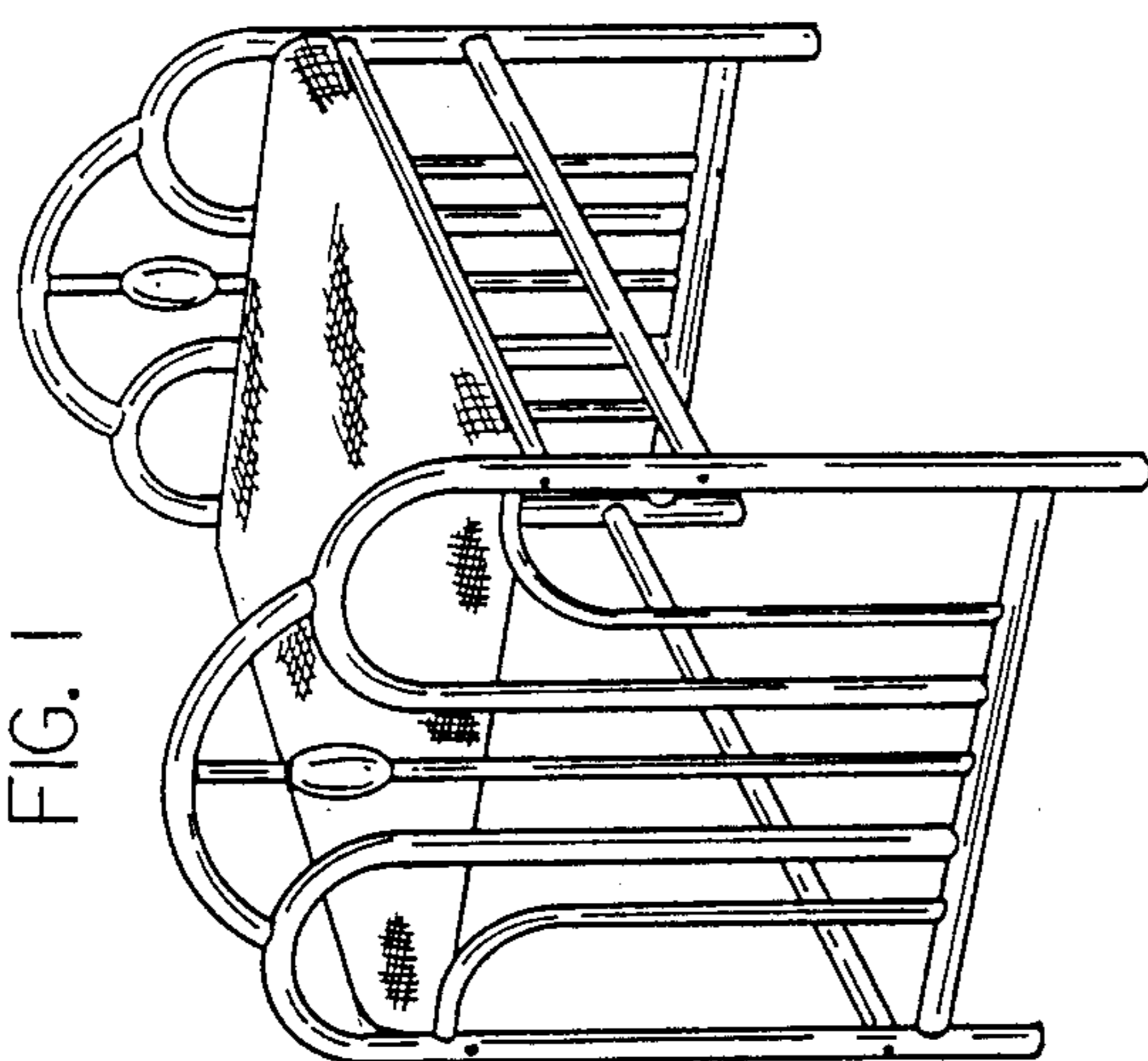

FIG. 1

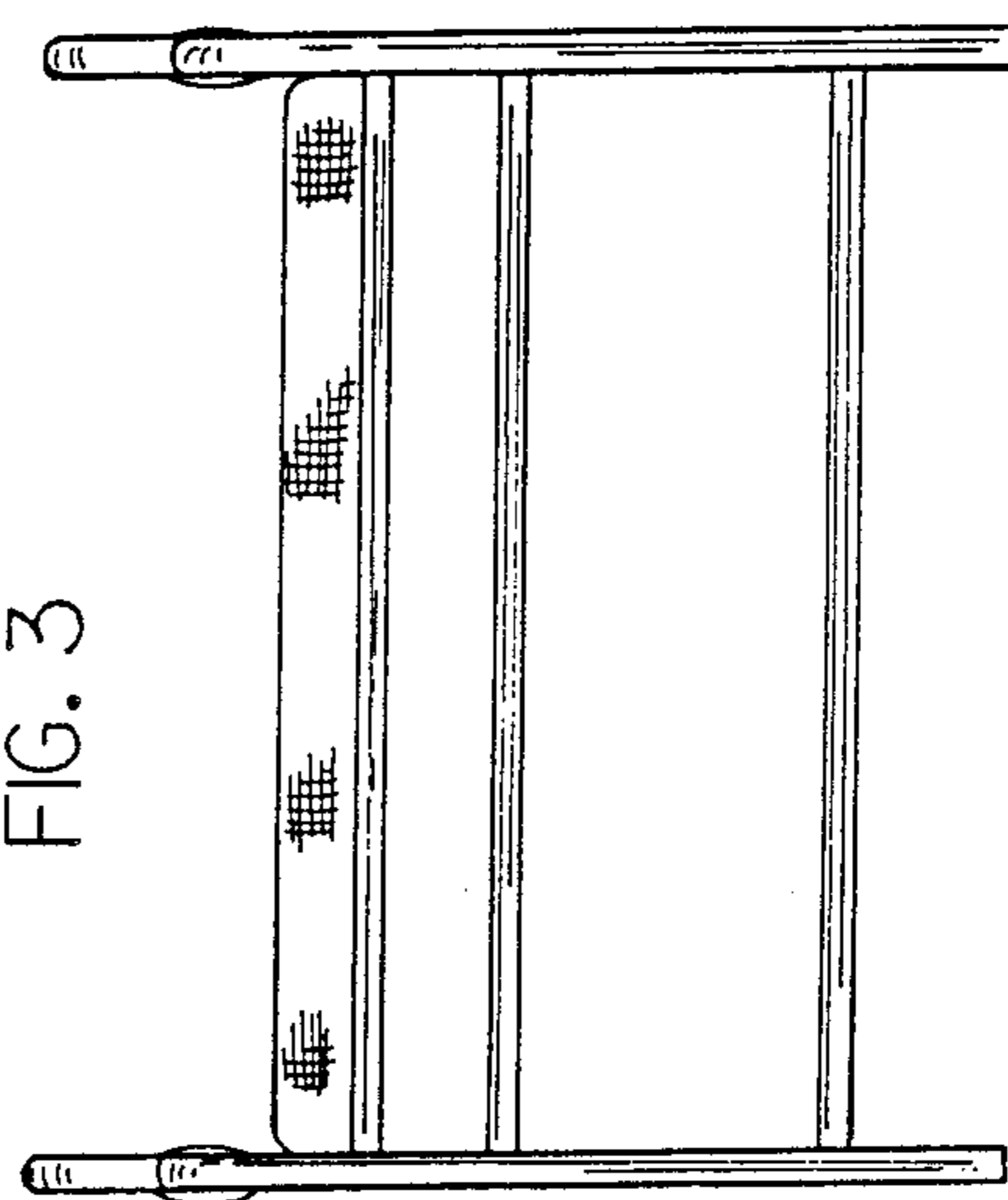

FIG. 3

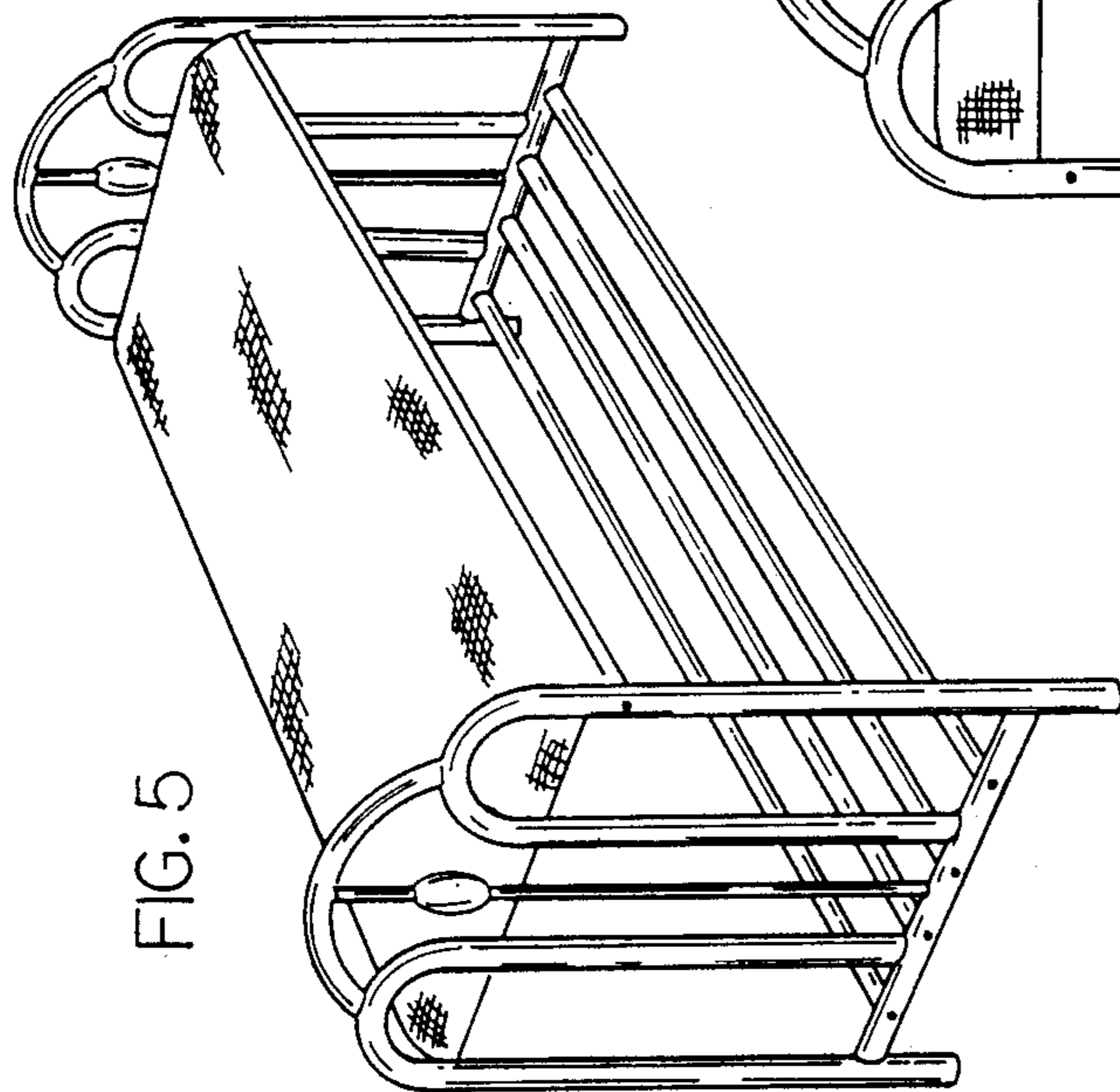

FIG. 5

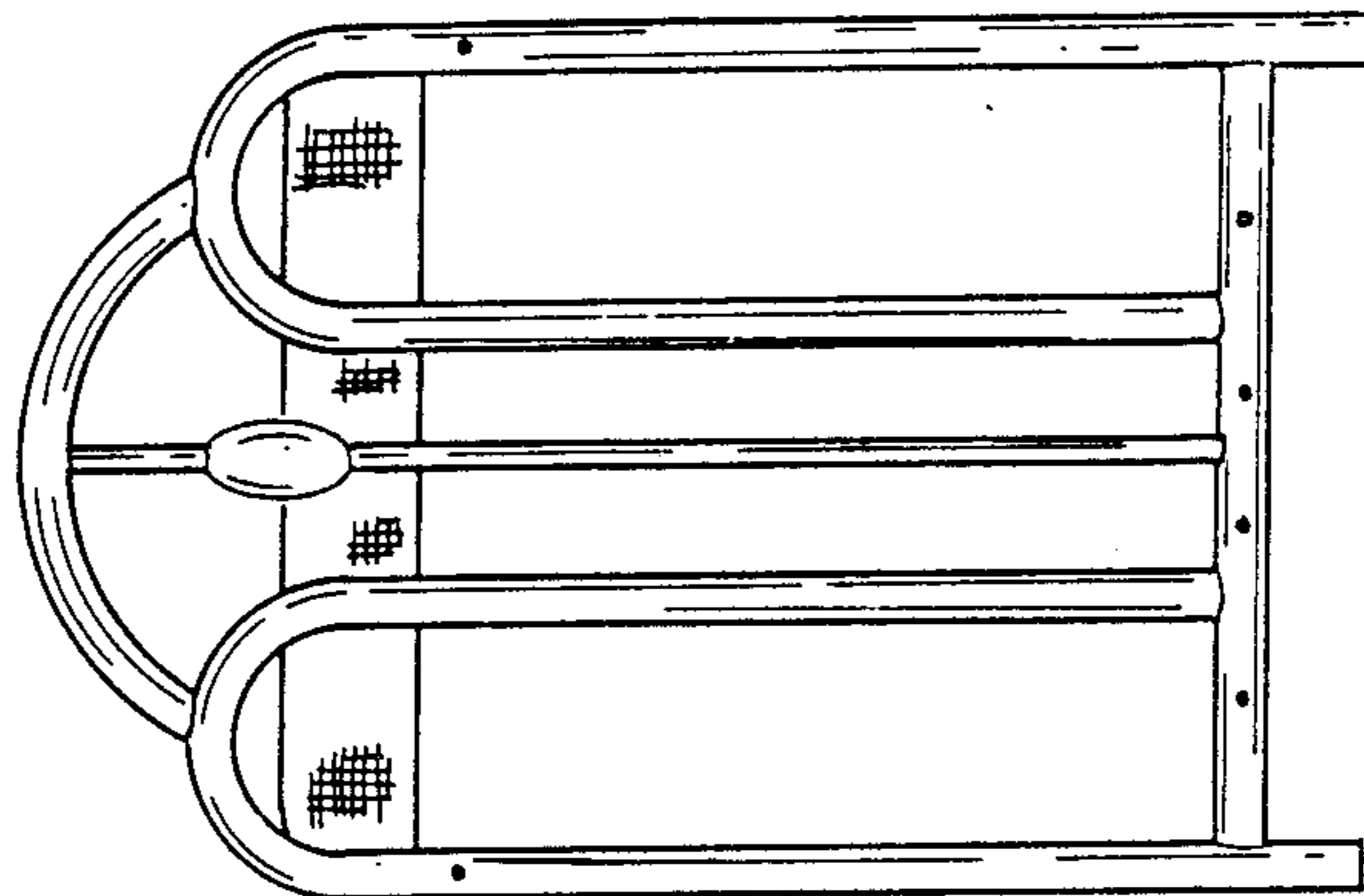

FIG. 6

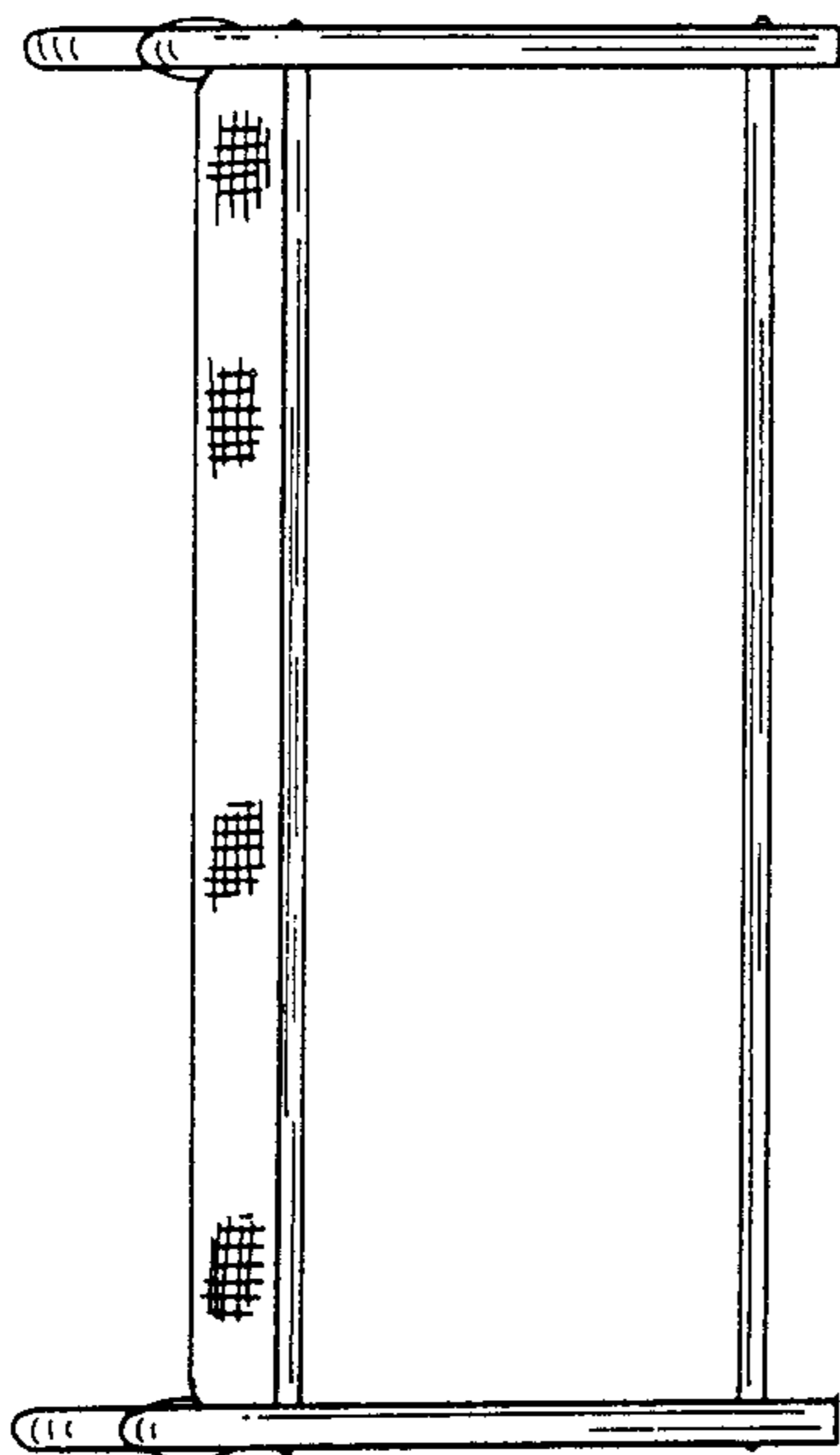

FIG. 7