

[54] SEAT
[75] Inventor: Hans Hopfer, Paris, France
[73] Assignee: Alex Synn AG, Cham, Switzerland
[**] Term: 14 Years
[21] Appl. No.: 165,162
[22] Filed: Mar. 7, 1988

[30] Foreign Application Priority Data
Sep. 7, 1987 [XH] Hague DM/009.239
[52] U.S. Cl. D6/334; D6/381;
D6/374
[58] Field of Search D6/334, 374, 381

[56] References Cited
U.S. PATENT DOCUMENTS
D. 263,770 4/1982 Melchoir D6/334
D. 281,655 12/1985 Carter D6/334
D. 282,423 2/1986 Carter D6/334

OTHER PUBLICATIONS
Schweiger Ind., Sofa.

Domus Catalog Special Edition, Dec. 1978, p. 63, lounge, top left.
Design Institute America, ©1983, armless chair 8028-12, left center.
Interiors, Jul. 1985, p. 199, lounge, top left.

Primary Examiner—Bruce W. Dunkins
Assistant Examiner—Ann Hunt
Attorney, Agent, or Firm—Cushman, Darby & Cushman

[57] CLAIM
The ornamental design for a seat, as shown.

DESCRIPTION
FIG. 1 is a front perspective view of the seat showing my new design;
FIG. 2 is a side elevational view thereof;
FIG. 3 is a front elevational view thereof;
FIG. 4 is a rear elevational view thereof;
FIG. 5 is a top plan view thereof;
FIG. 6 is a front perspective view of a second embodiment of the seat showing my new design;
FIG. 7 is a side elevational view thereof;
FIG. 8 is a front elevational view thereof;
FIG. 9 is a rear elevational view thereof; and
FIG. 10 is a top plan view thereof.

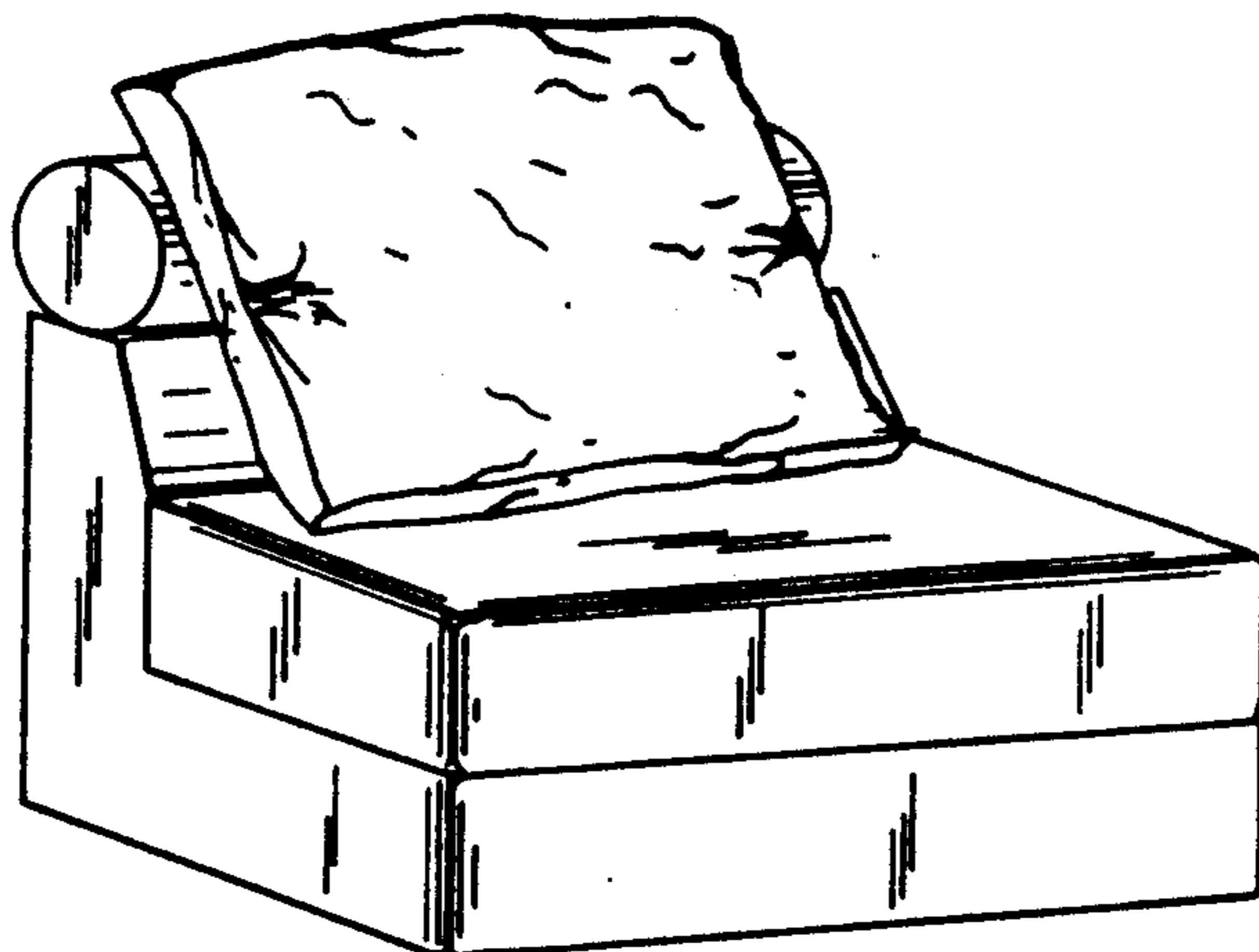

Fig. 1

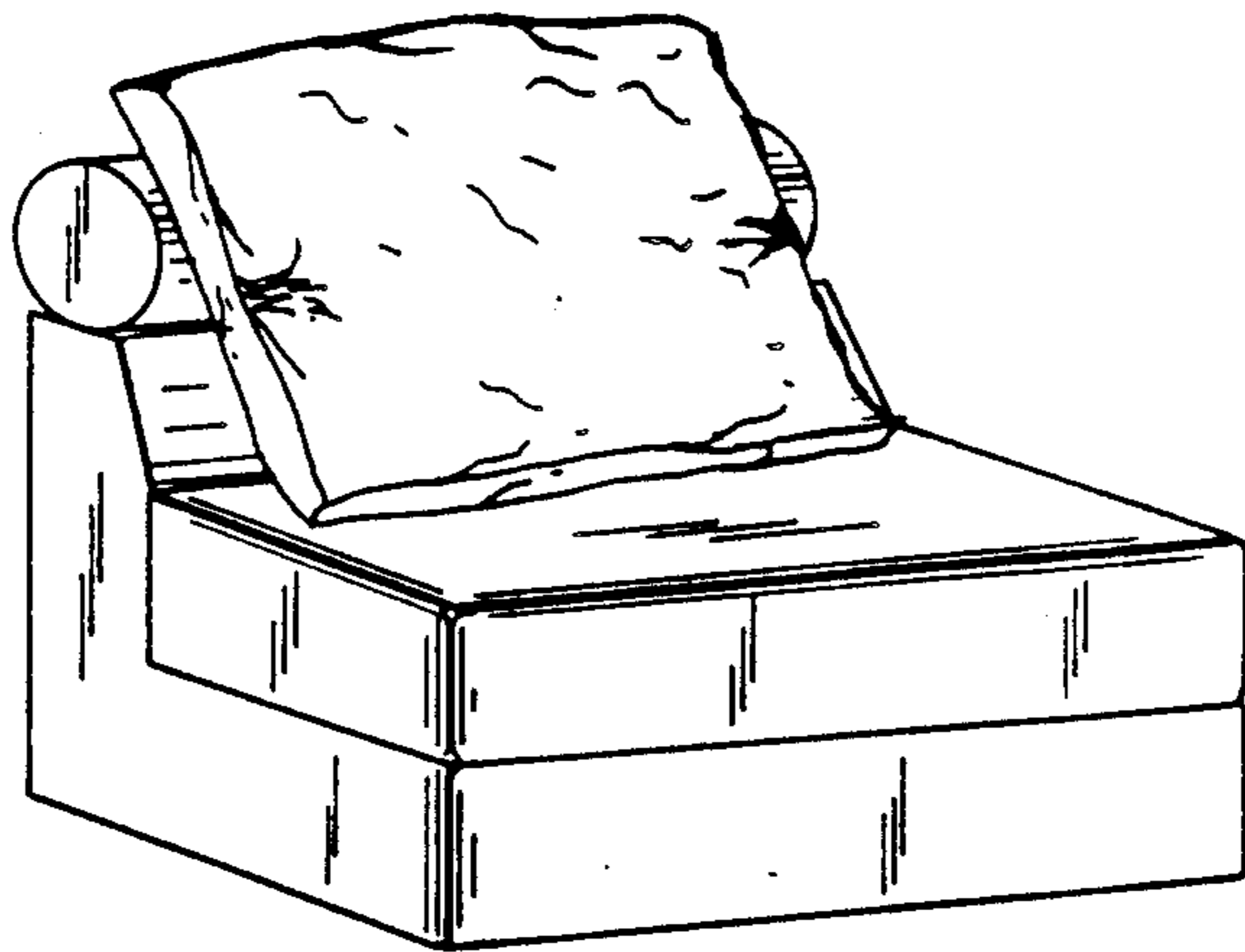

Fig. 2

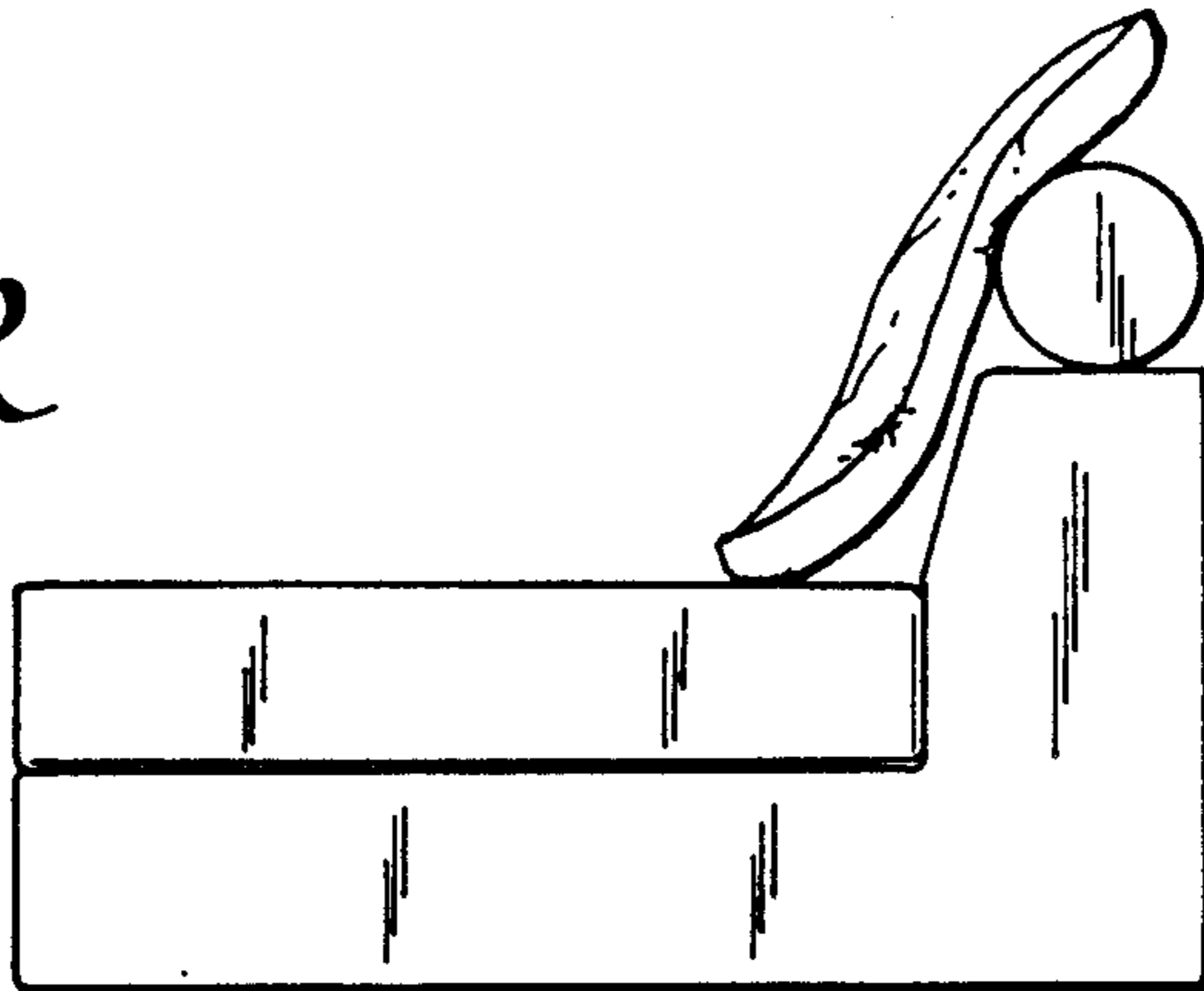

Fig. 3

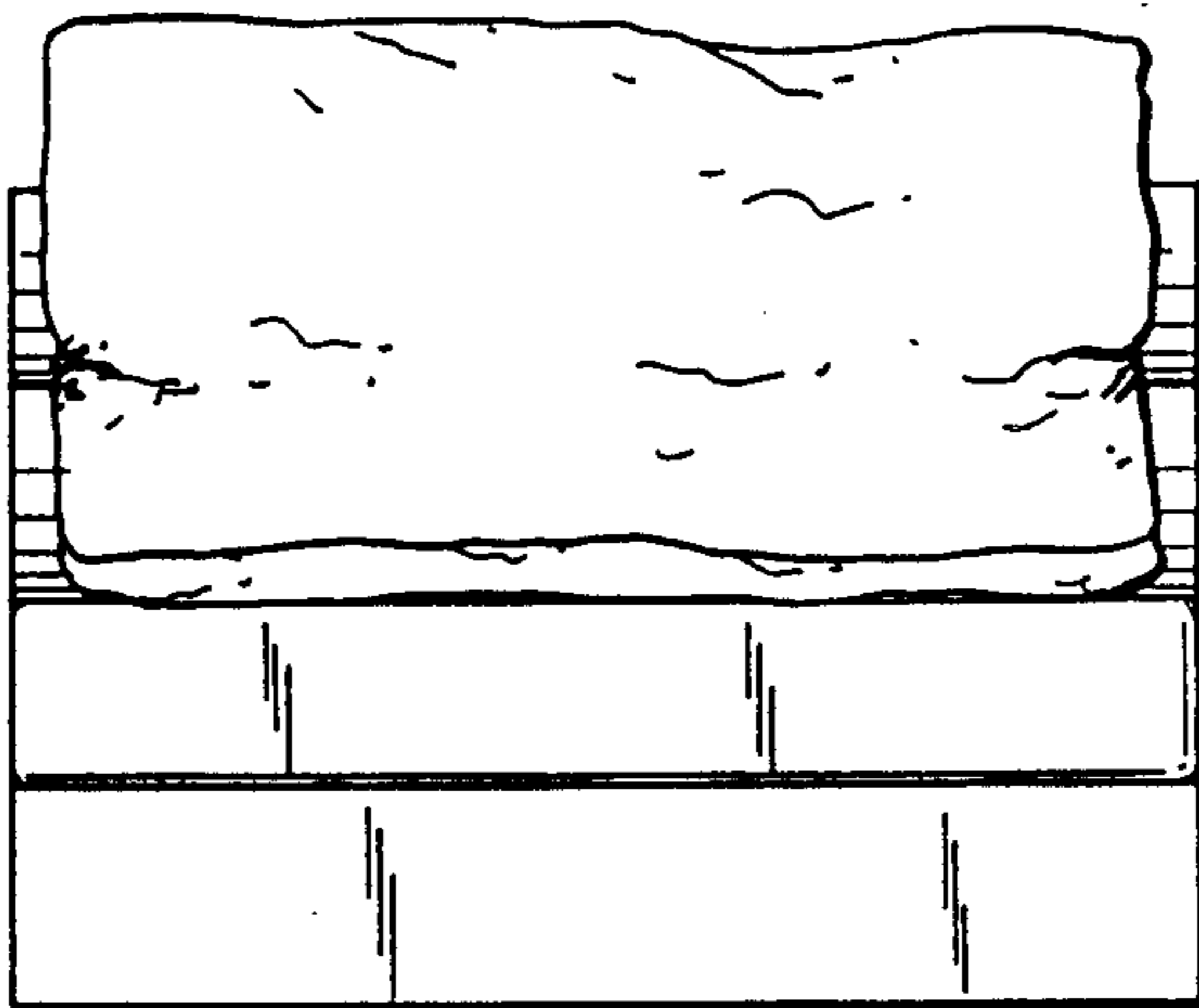

Fig. 4

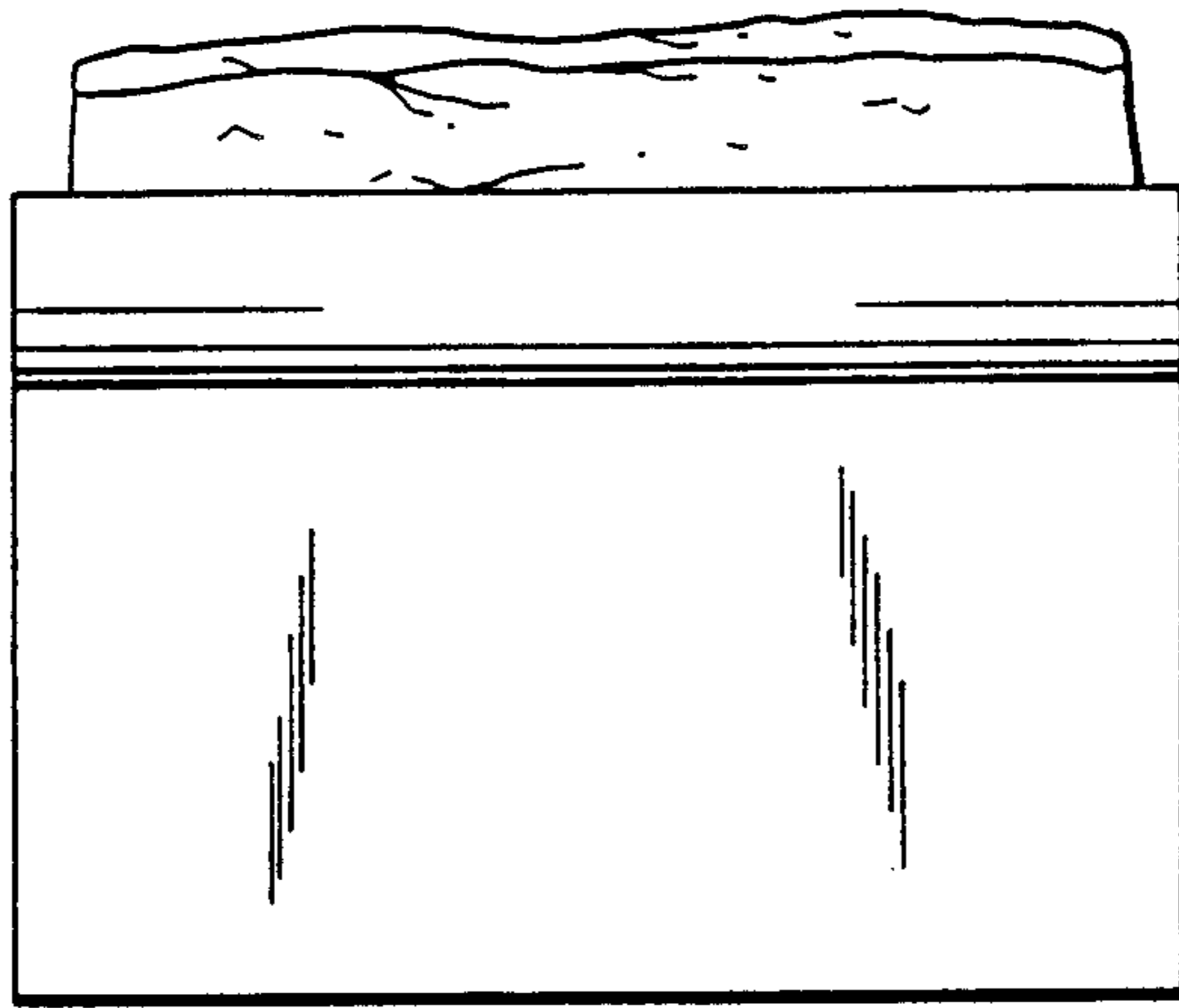

Fig. 5

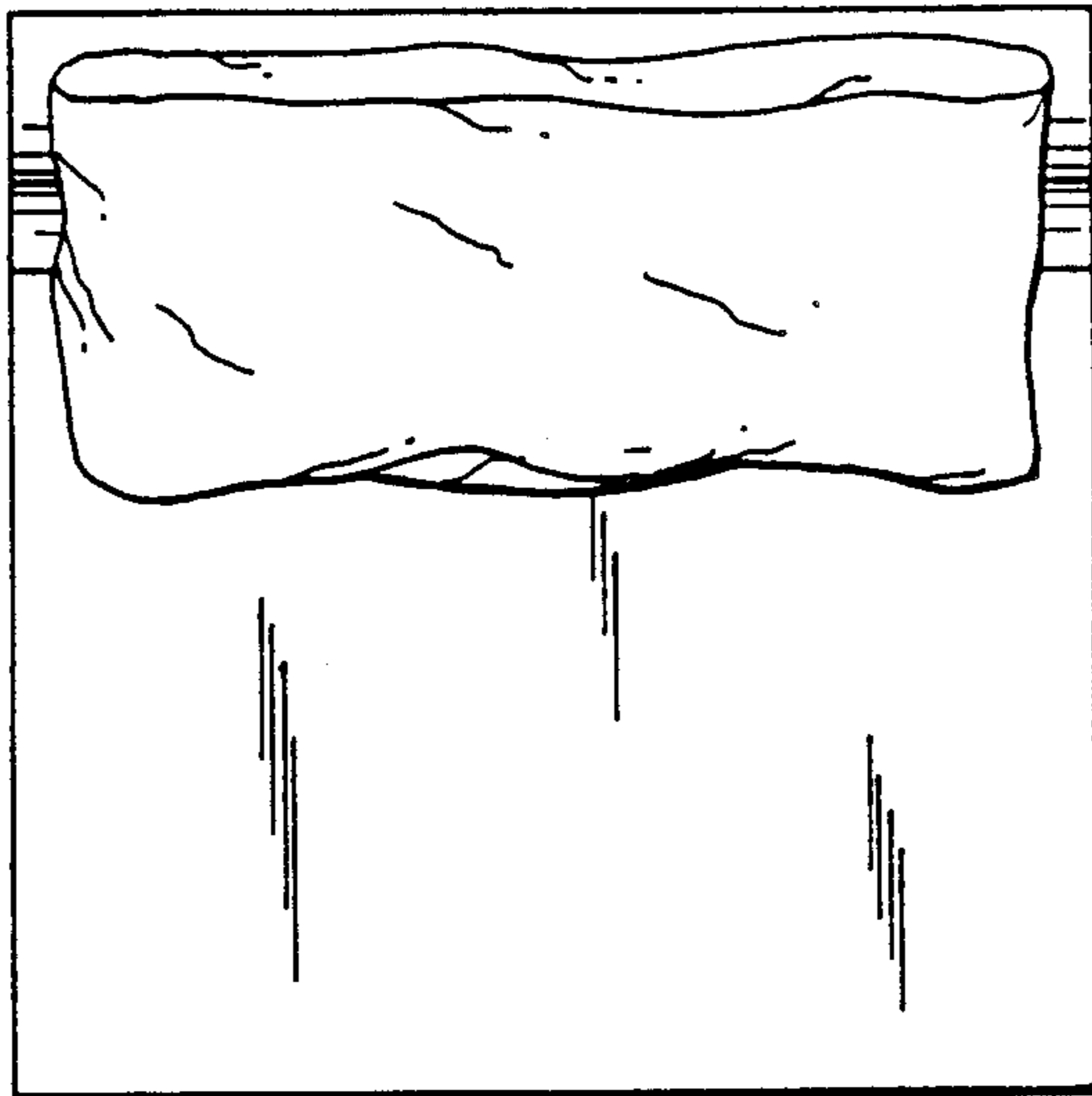

Fig. 6

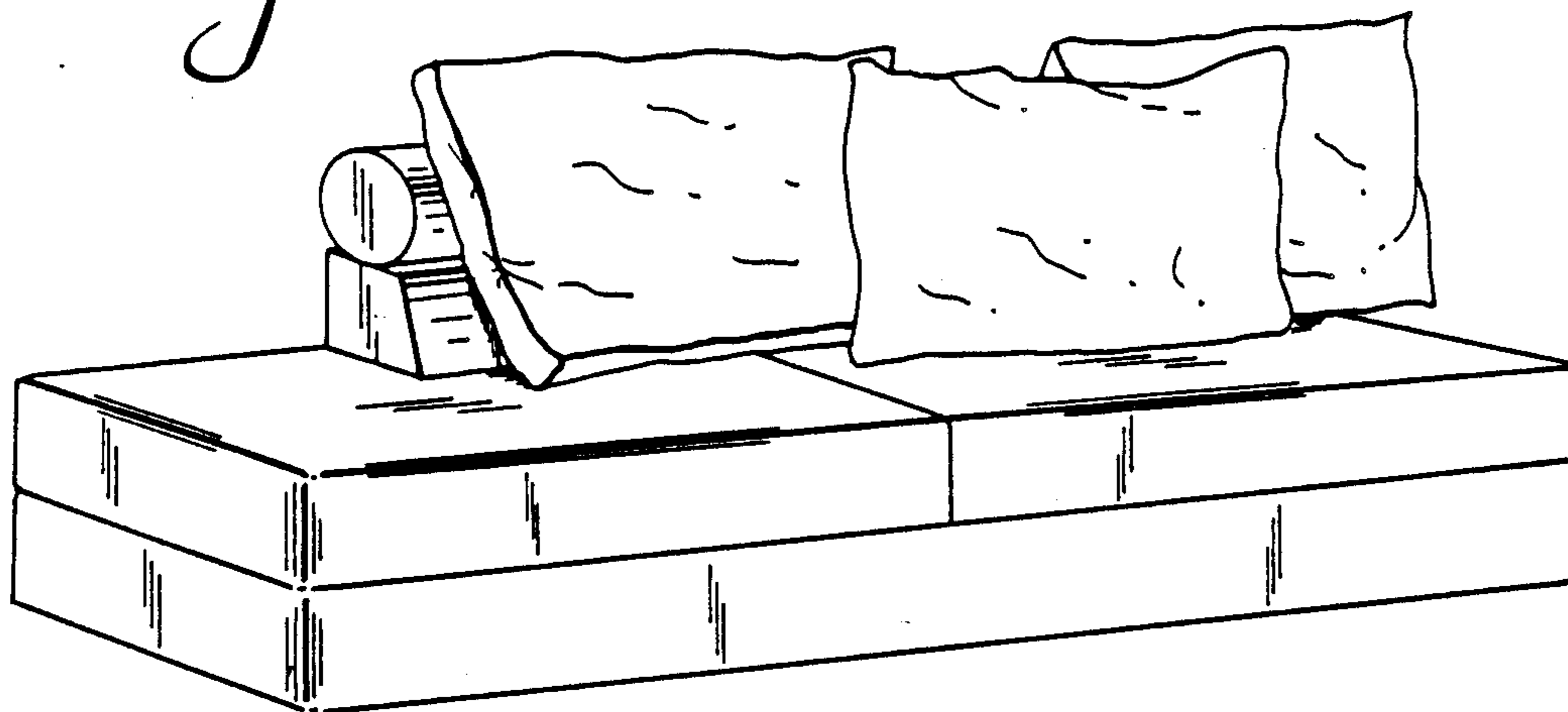

Fig. 7

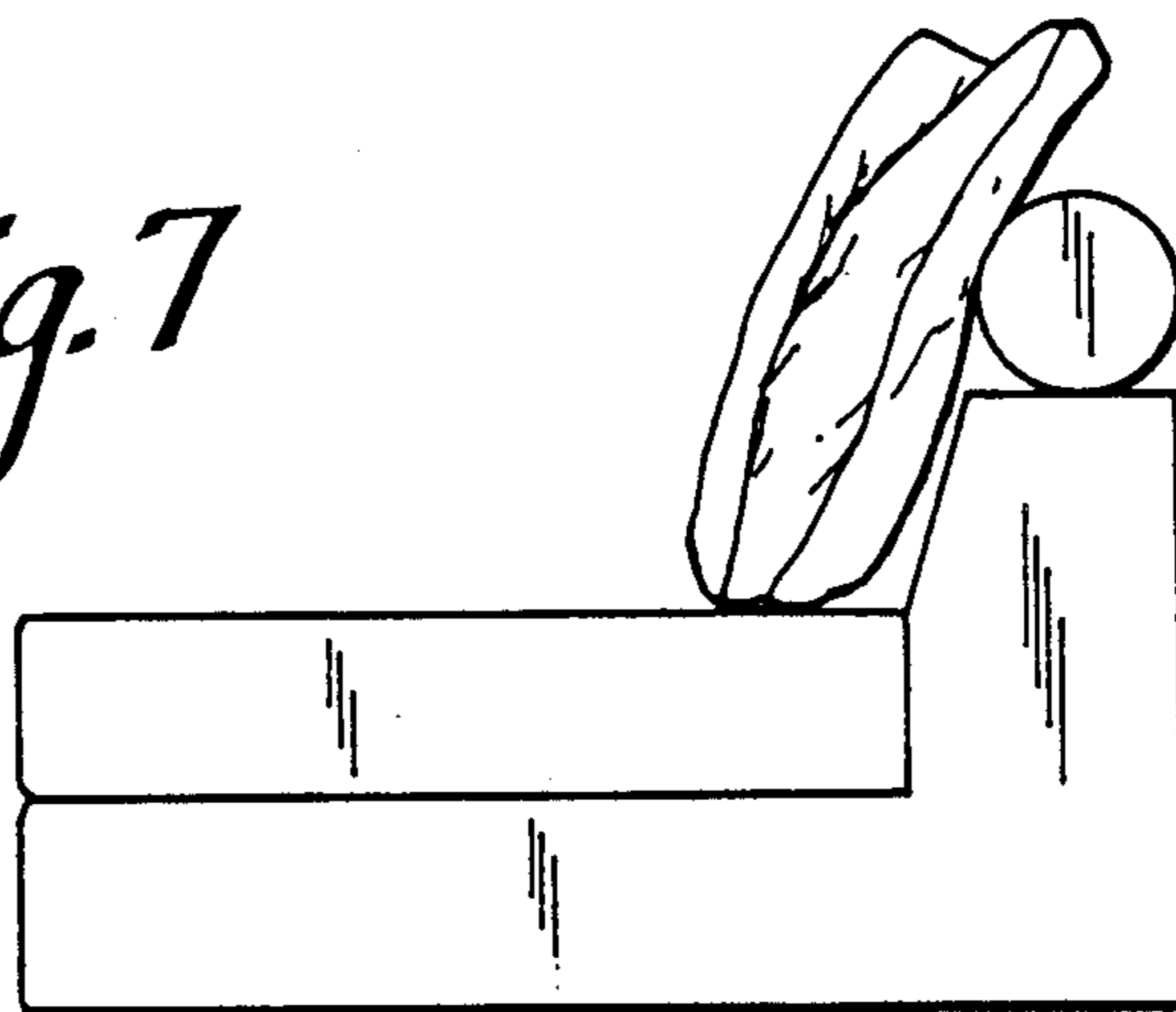
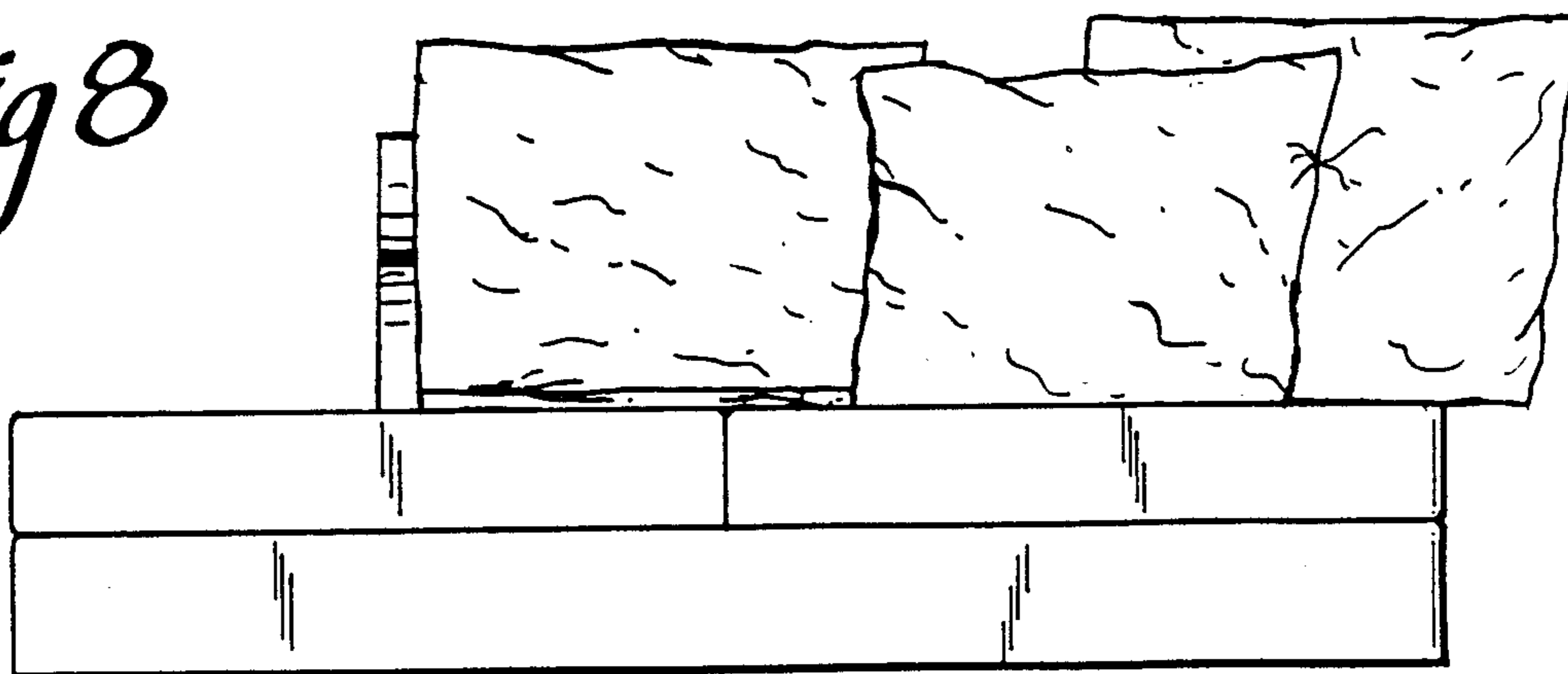

Fig. 8



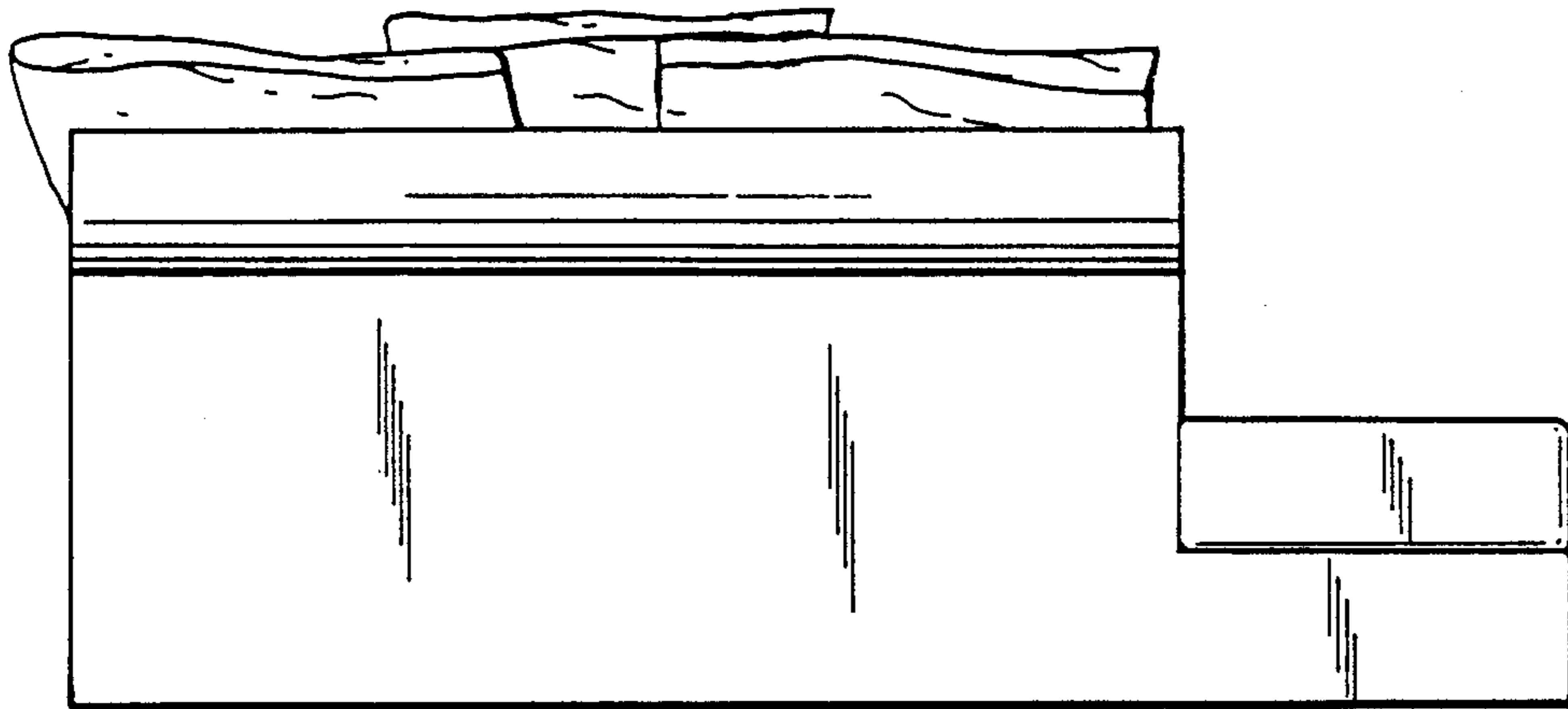

Fig. 9

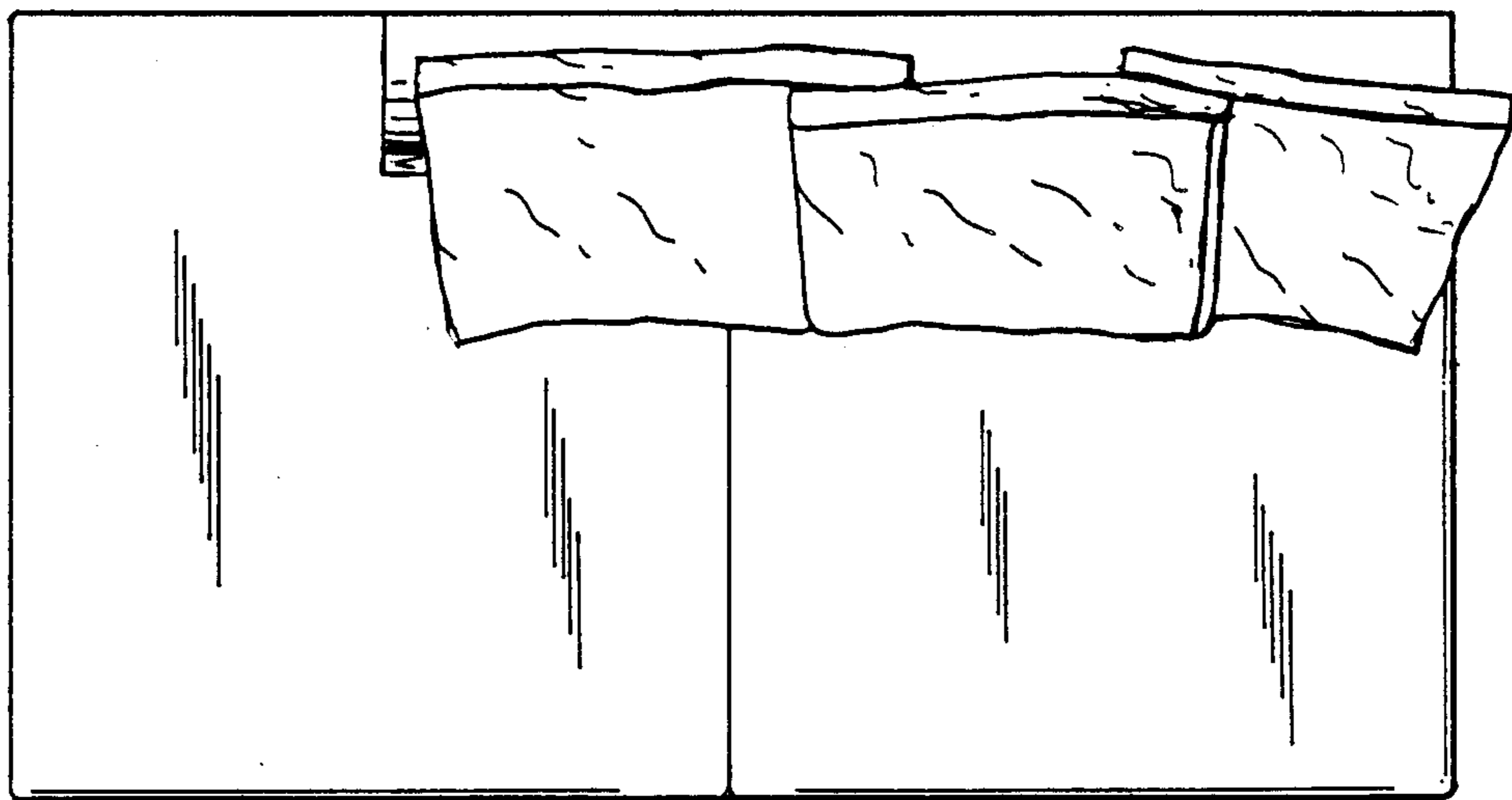

Fig. 10