

[54] **PORTABLE WATER FILTER**

[76] **Inventor: Robert S. Luzenberg, Jr., 135 First St.
East, Unit 301, Tierra Verde, Fla.
33715**

[**] **Term: 14 Years**

[21] **Appl. No.: 48,921**

[22] **Filed: May 13, 1987**

Related U.S. Application Data

[63] **Continuation-in-part of Ser. No. 936,376, Dec. 1, 1986,
Pat. No. 296,352.**

[52] **U.S. Cl. D23/209**

[58] **Field of Search D23/207-210;
210/437, 409, 449, 435, 443-448, 282, 416.3**

[56] **References Cited**

U.S. PATENT DOCUMENTS

275,978	4/1883	Barrington	210/449
D. 296,352	6/1988	Luzenberg	D23/208
494,837	4/1893	Bellamy	210/449
2,314,357	4/1940	Lehman	210/449

Primary Examiner—Susan J. Lucas

Assistant Examiner—M. H. Tung

[57] **CLAIM**

The ornamental design for a portable water filter, as shown and described.

DESCRIPTION

FIG. 1 is an isometric view of a portable water filter showing my new design, with the broken lines shown for illustrative purposes only and forming no part of my claimed design;

FIG. 2 is an isometric view showing the top thereof;

FIG. 3 is an isometric view showing the bottom thereof;

FIG. 4 is a side elevational view thereof;

FIG. 5 is a top plan view thereof; and

FIG. 6 is a bottom plan view thereof.

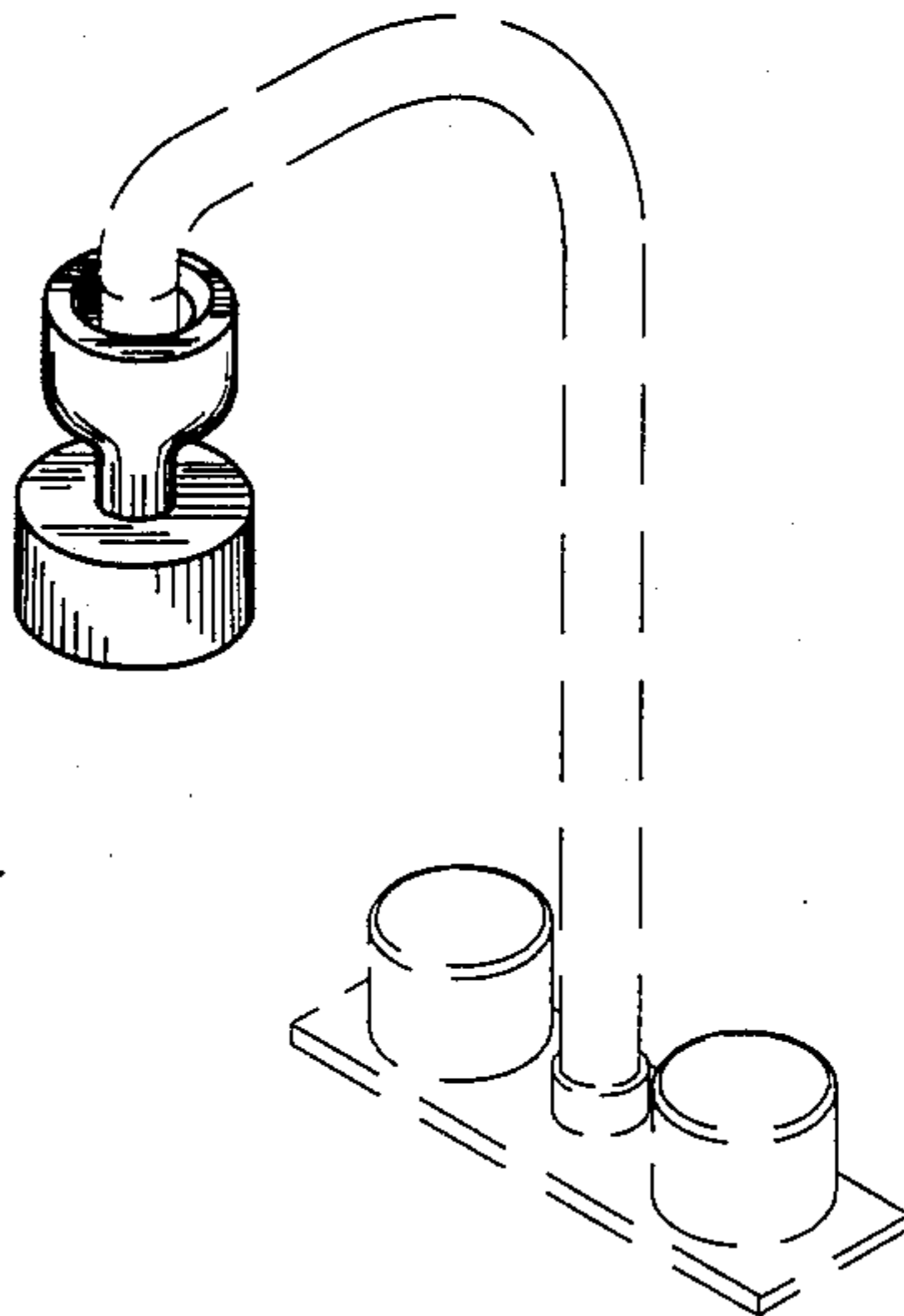

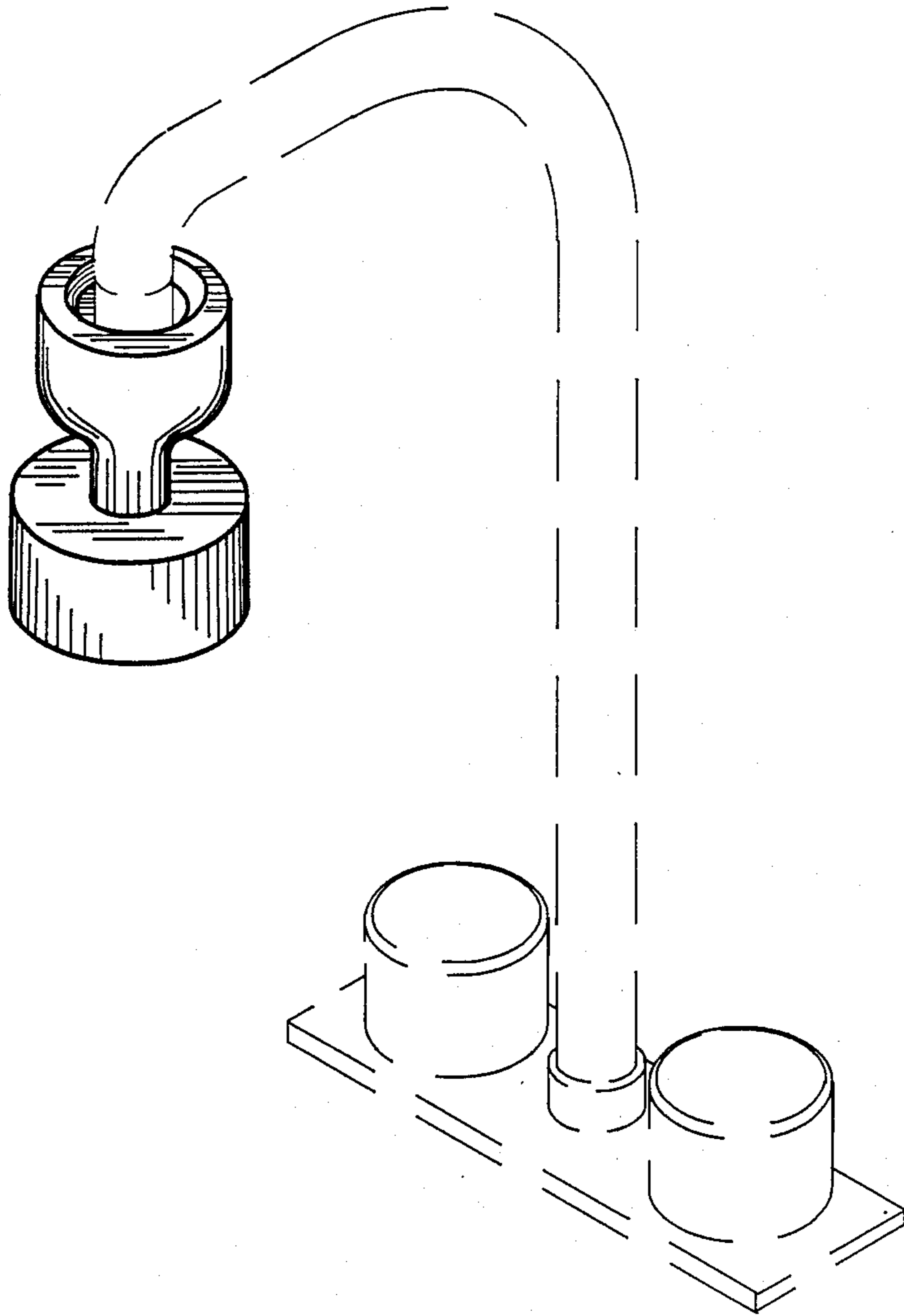

FIG. 1

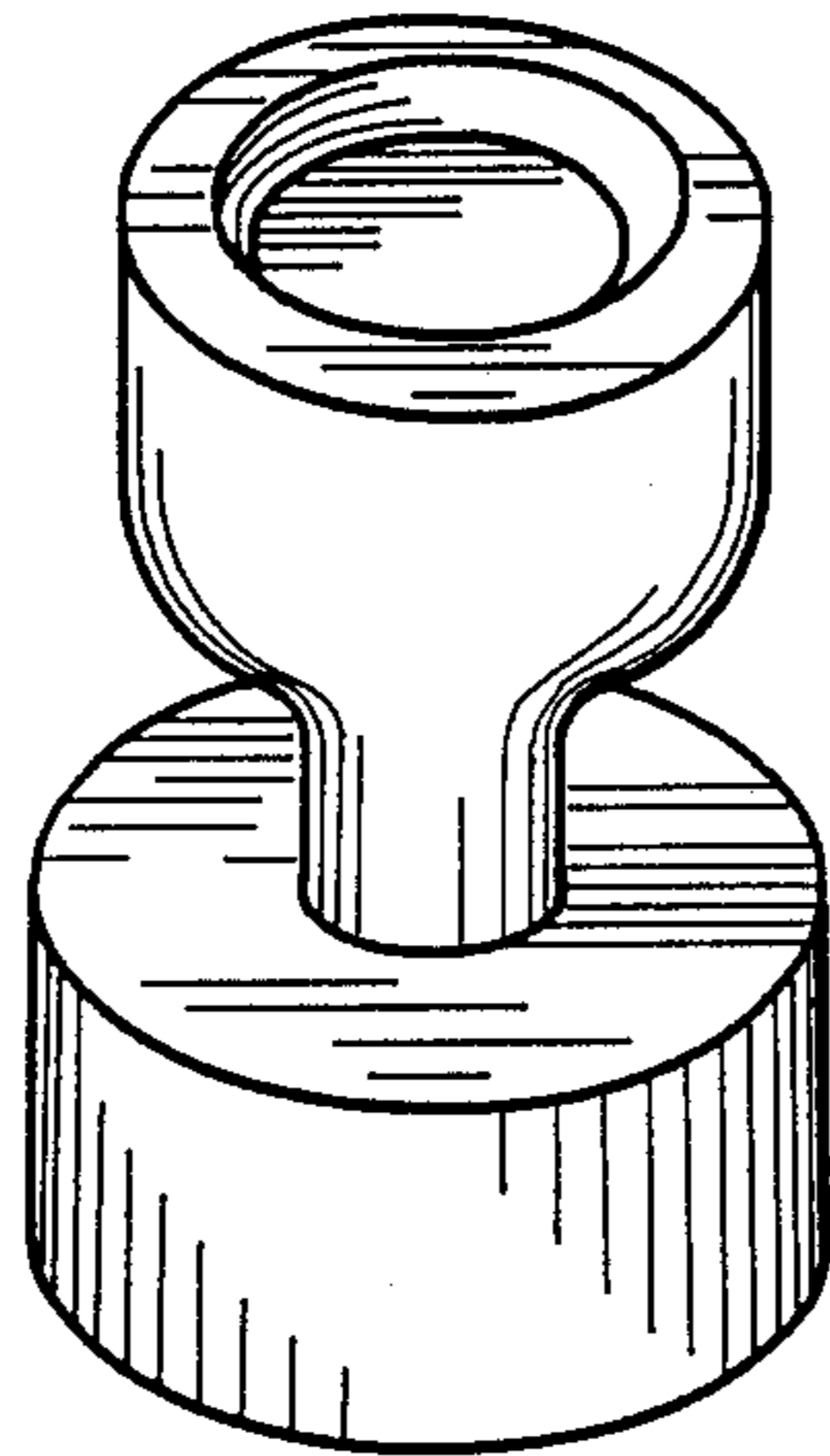

FIG. 2

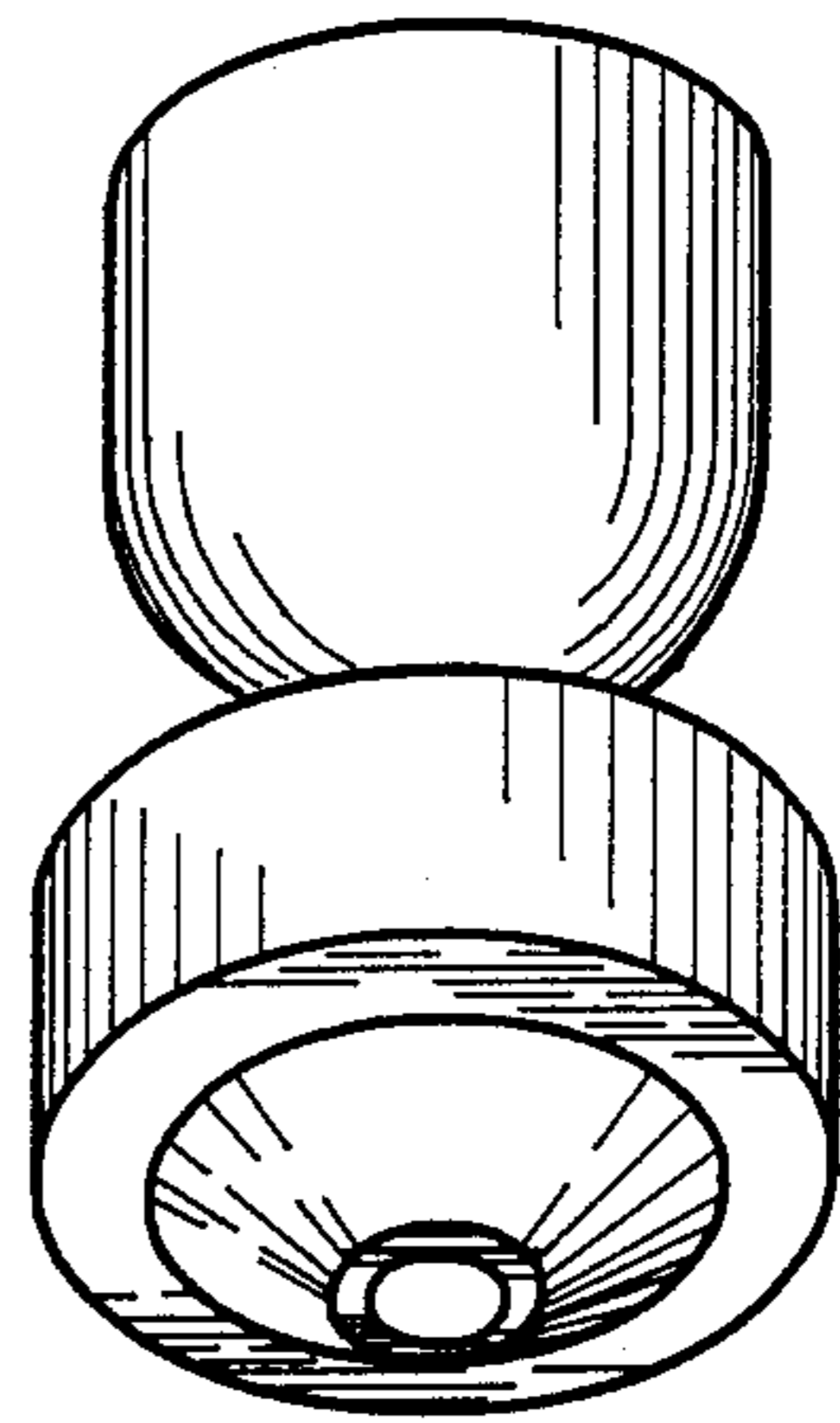

FIG. 3

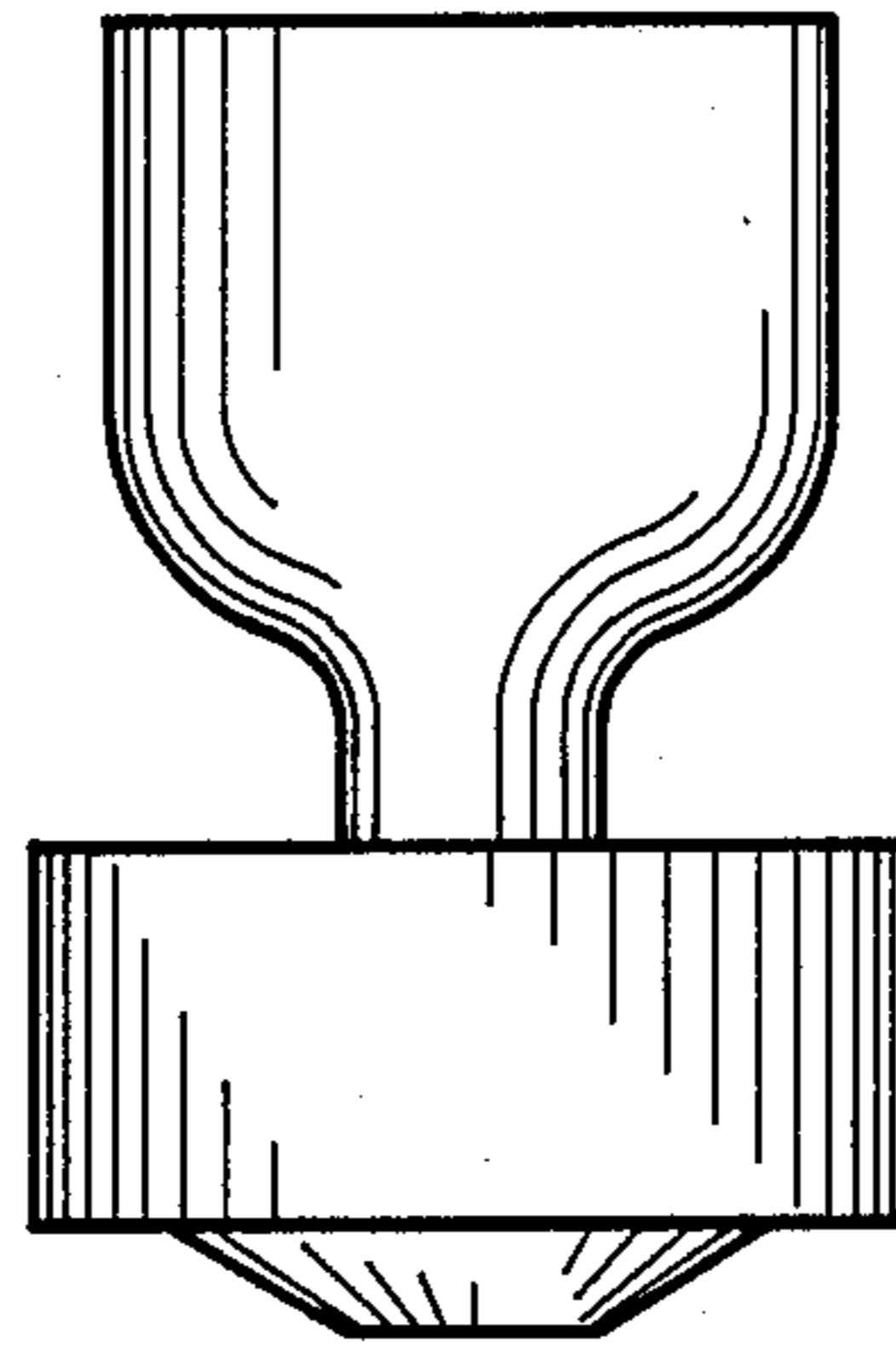

FIG. 4

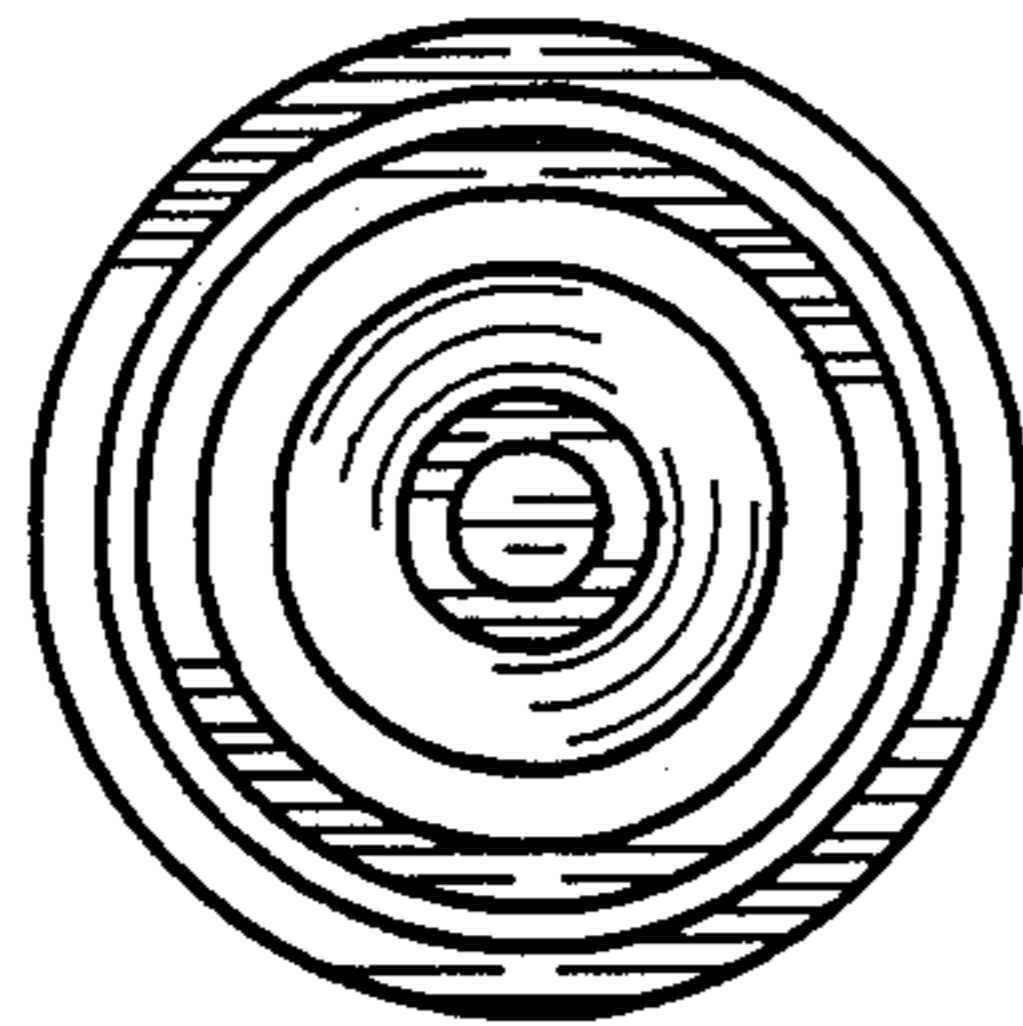

FIG. 5

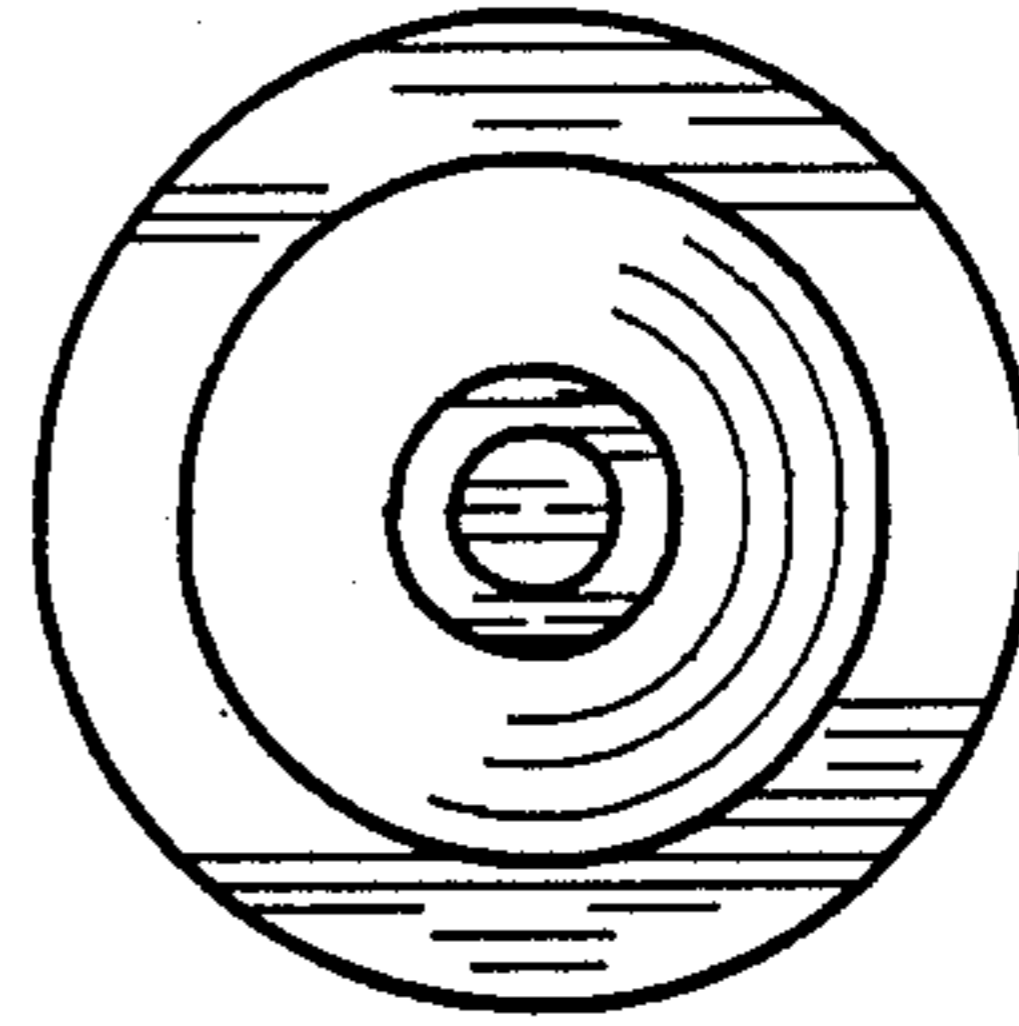

FIG. 6