

[54] TELEPHONE INDEX

[75] Inventor: Hans Halm, Herne, Fed. Rep. of Germany

[73] Assignee: Confon AG, Rheineck, Switzerland

[**] Term: 14 Years

[21] Appl. No.: 32,082

[22] Filed: Mar. 27, 1987

[30] Foreign Application Priority Data

Dec. 1, 1986 [DE] Fed. Rep. of Germany ... 8626166[U]
Mar. 20, 1987 [DE] Fed. Rep. of Germany URA 317/87

[52] U.S. Cl. D19/76; D19/95

[58] Field of Search D19/76; 40/389, 390, 40/391, 392, 393

[56] References Cited

U.S. PATENT DOCUMENTS

D. 231,953	6/1974	Beger	D19/76
D. 234,160	1/1975	Mori	D19/76
D. 249,047	8/1978	Greif	D19/76
D. 249,153	8/1978	Glaubinger et al.	D19/76
D. 254,916	5/1980	Mori	D19/76
D. 259,885	7/1981	Halm	D19/76
D. 272,636	2/1984	Sekit	D19/76
D. 277,395	1/1985	Ippen	D19/76
D. 282,179	1/1986	Yuen	D19/76
2,513,422	7/1950	Neilsen	40/389

Primary Examiner—Bruce W. Dunkins
Assistant Examiner—Martha Thompson
Attorney, Agent, or Firm—Toren, McGeady & Associates

[57] CLAIM

The ornamental design for a telephone index, as shown and described.

DESCRIPTION

FIG. 1 is a perspective view of a telephone index showing my new design in a closed condition;
FIG. 2 is a perspective view in an opened condition;
FIG. 3 is a top plan view of FIG. 1;
FIG. 4 is a front elevational view of FIG. 1;
FIG. 5 is a rear elevational view of FIG. 1;
FIG. 6 is a side elevational view of FIG. 1, the opposite side being a mirror image thereof;
FIG. 7 is a bottom plan view thereof;
FIG. 8 is a perspective view of a second embodiment of my new design in a closed condition;
FIG. 9 is a perspective view of the second embodiment in an opened condition;
FIG. 10 is a top plan view of FIG. 8;
FIG. 11 is a front elevational view of FIG. 8;
FIG. 12 is a rear elevational view of FIG. 8;
FIG. 13 is a side elevational view of FIG. 8, the opposite side being a mirror image thereof;
FIG. 14 is a bottom plan view of FIG. 8; and
FIG. 15 is an enlarged fragmentary perspective view of a key member of FIG. 8.

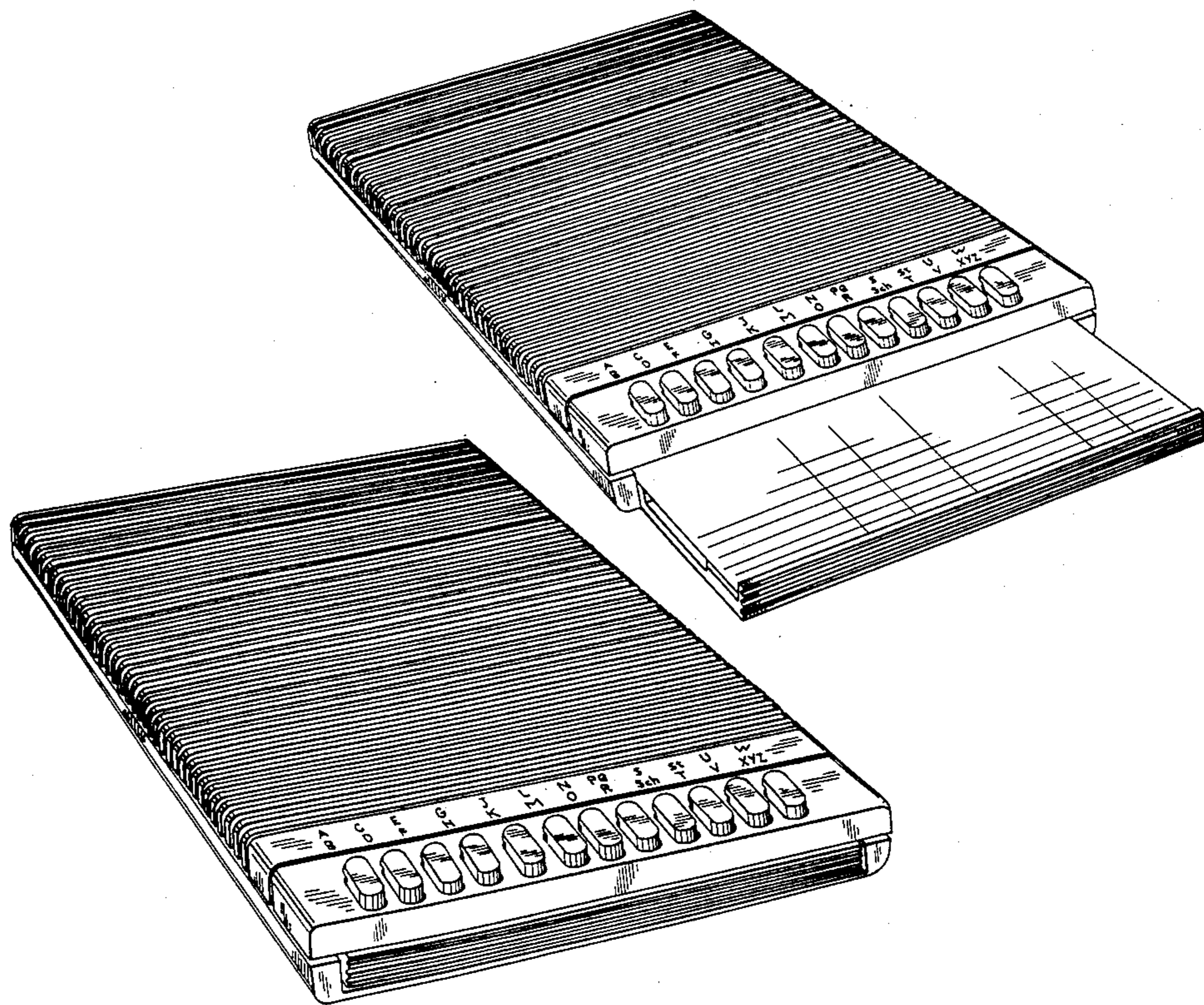

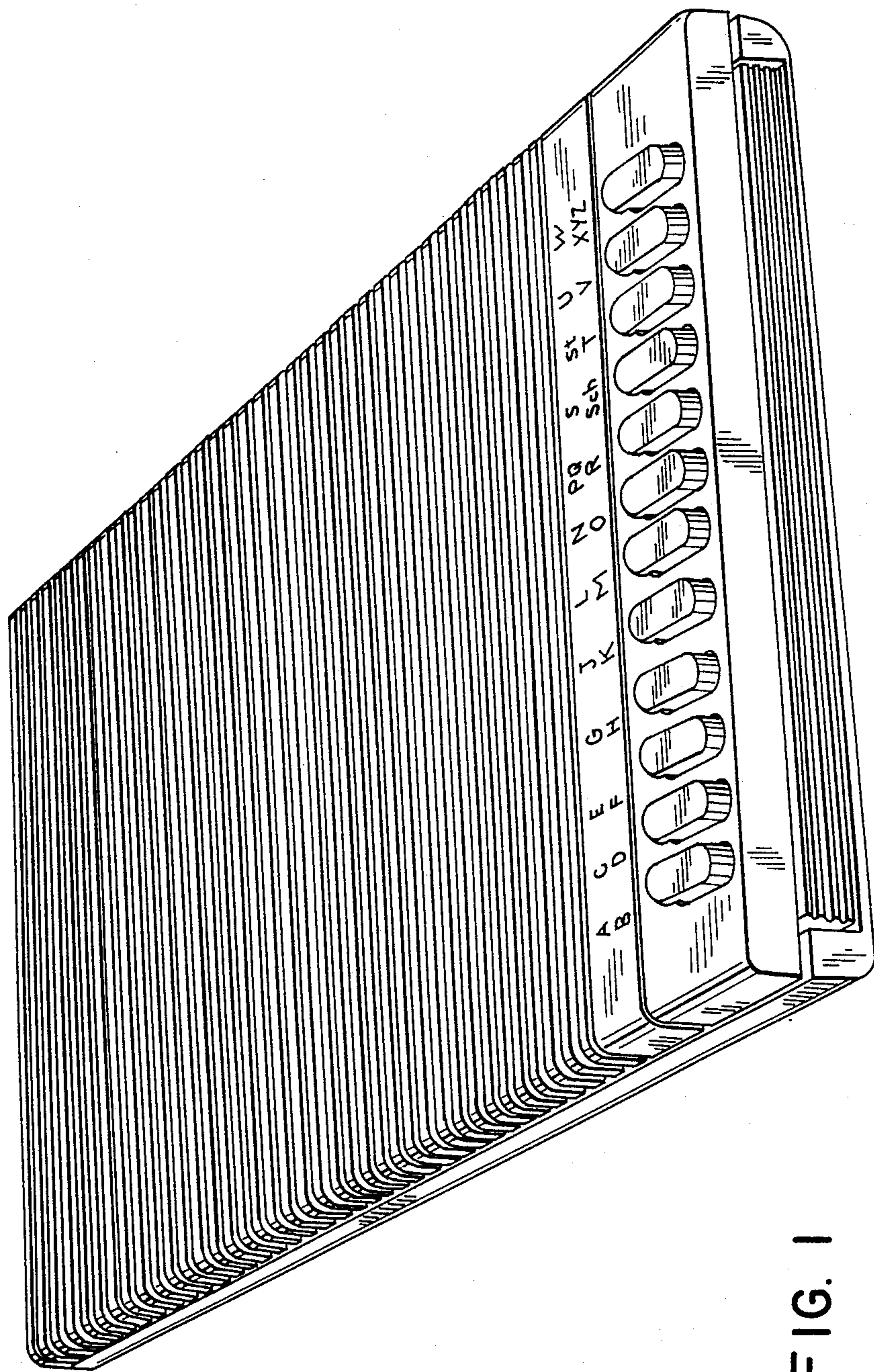
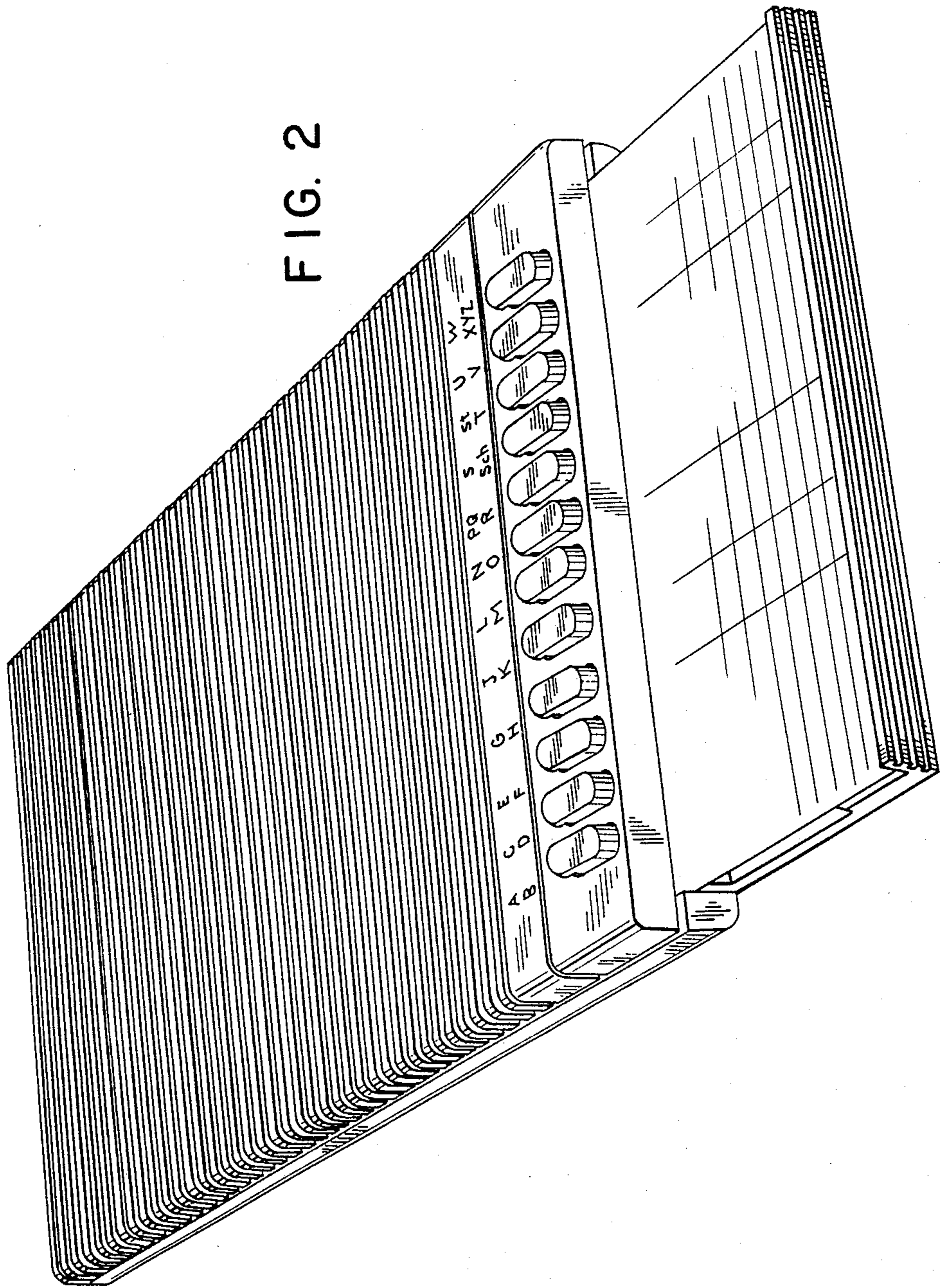

FIG. 1

FIG. 2



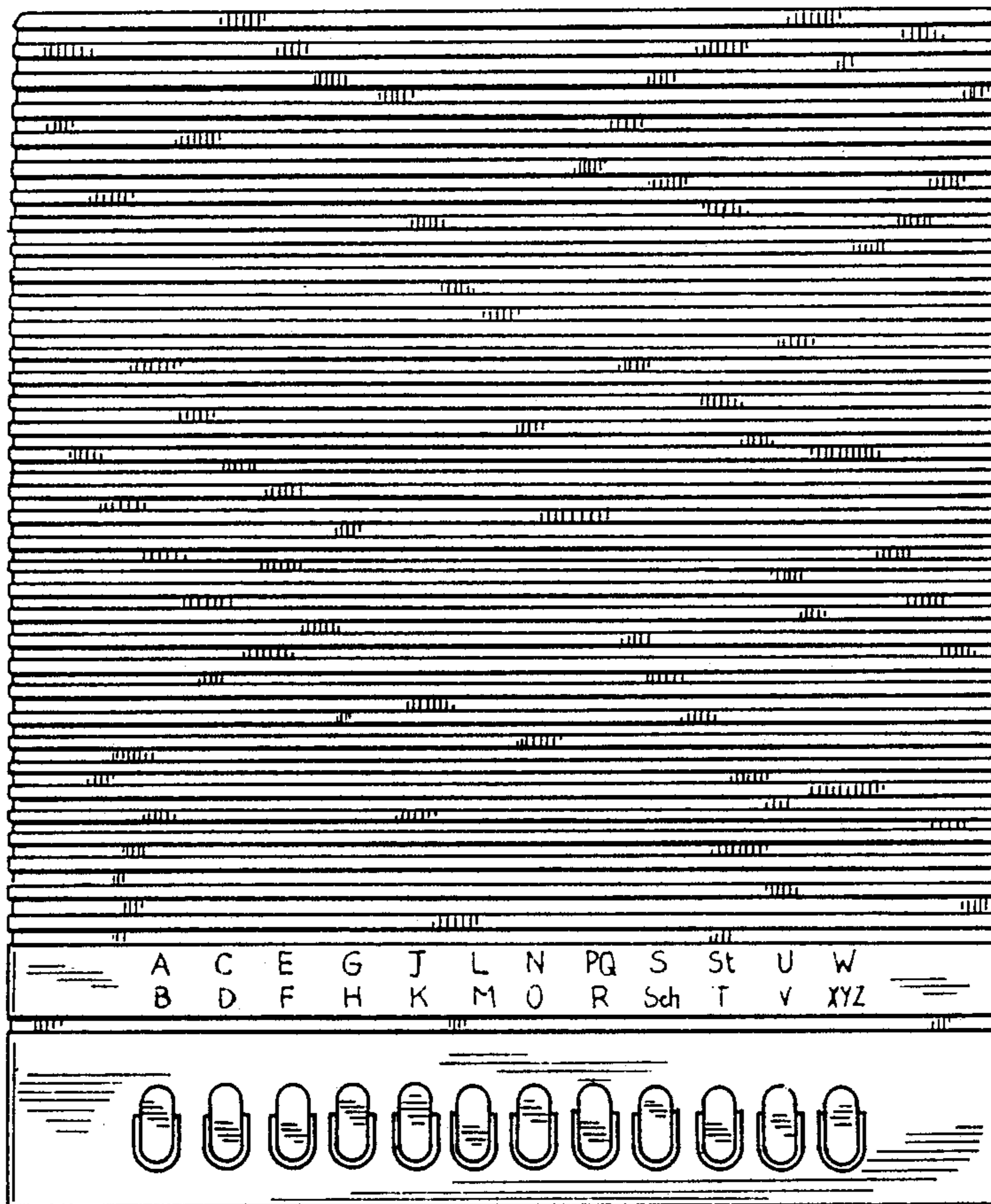

FIG. 3

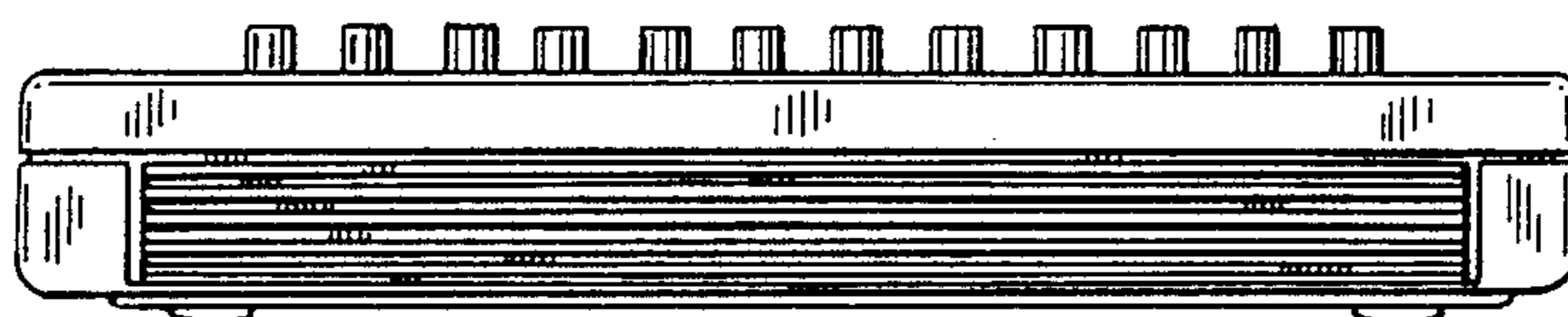

FIG. 4

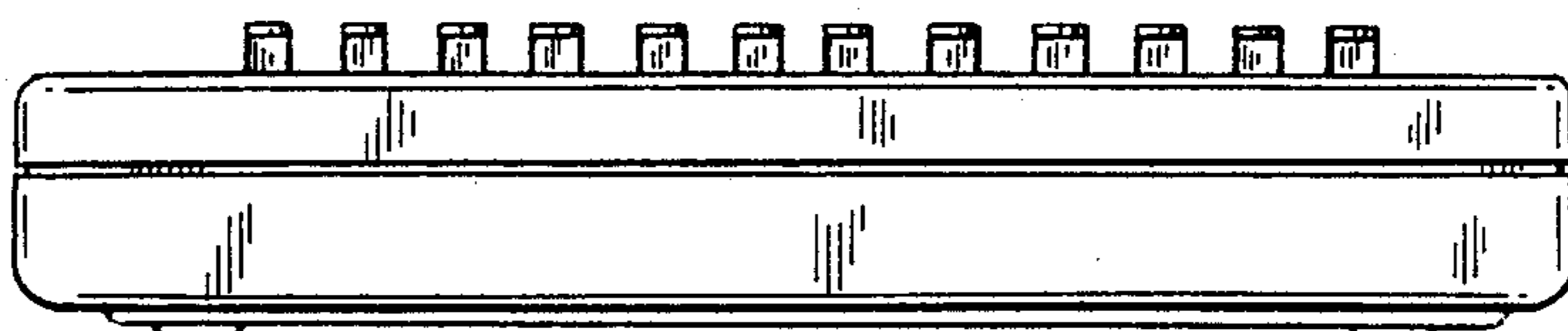

FIG. 5

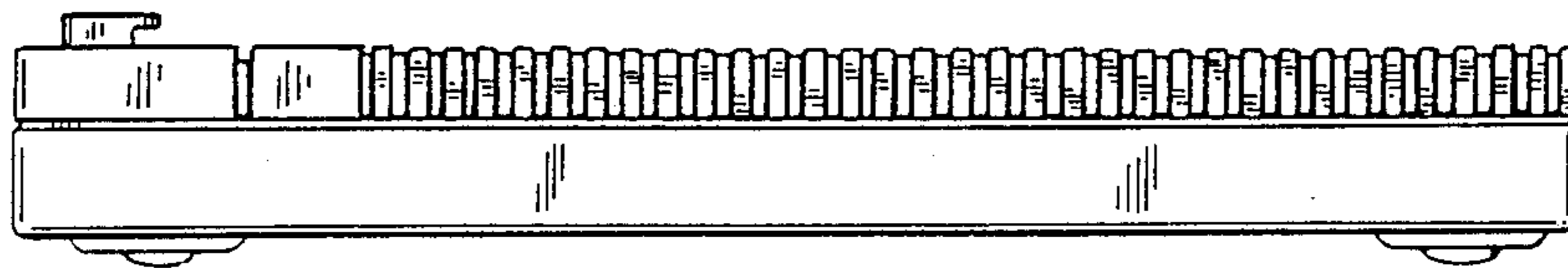

FIG. 6

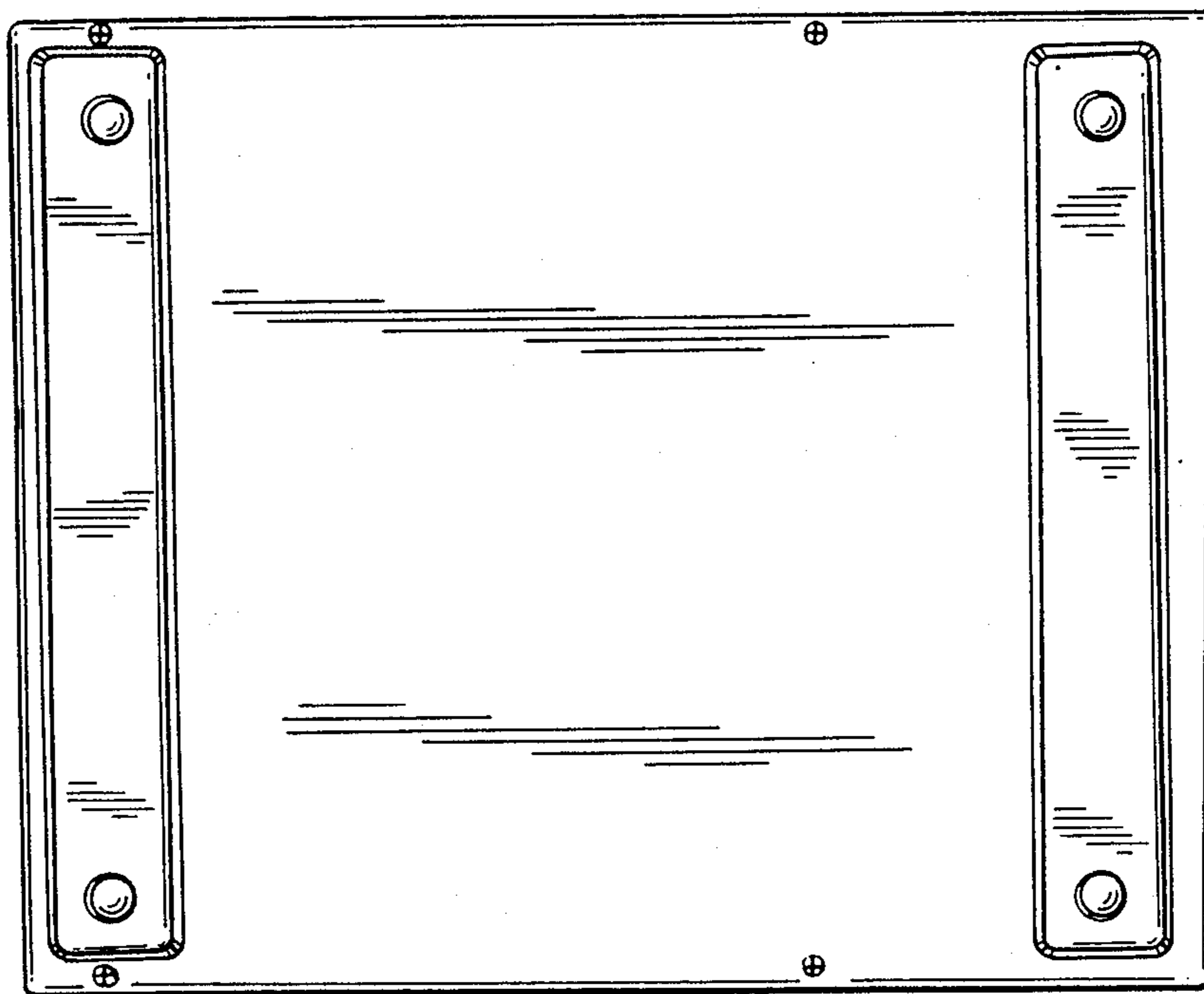

FIG. 7

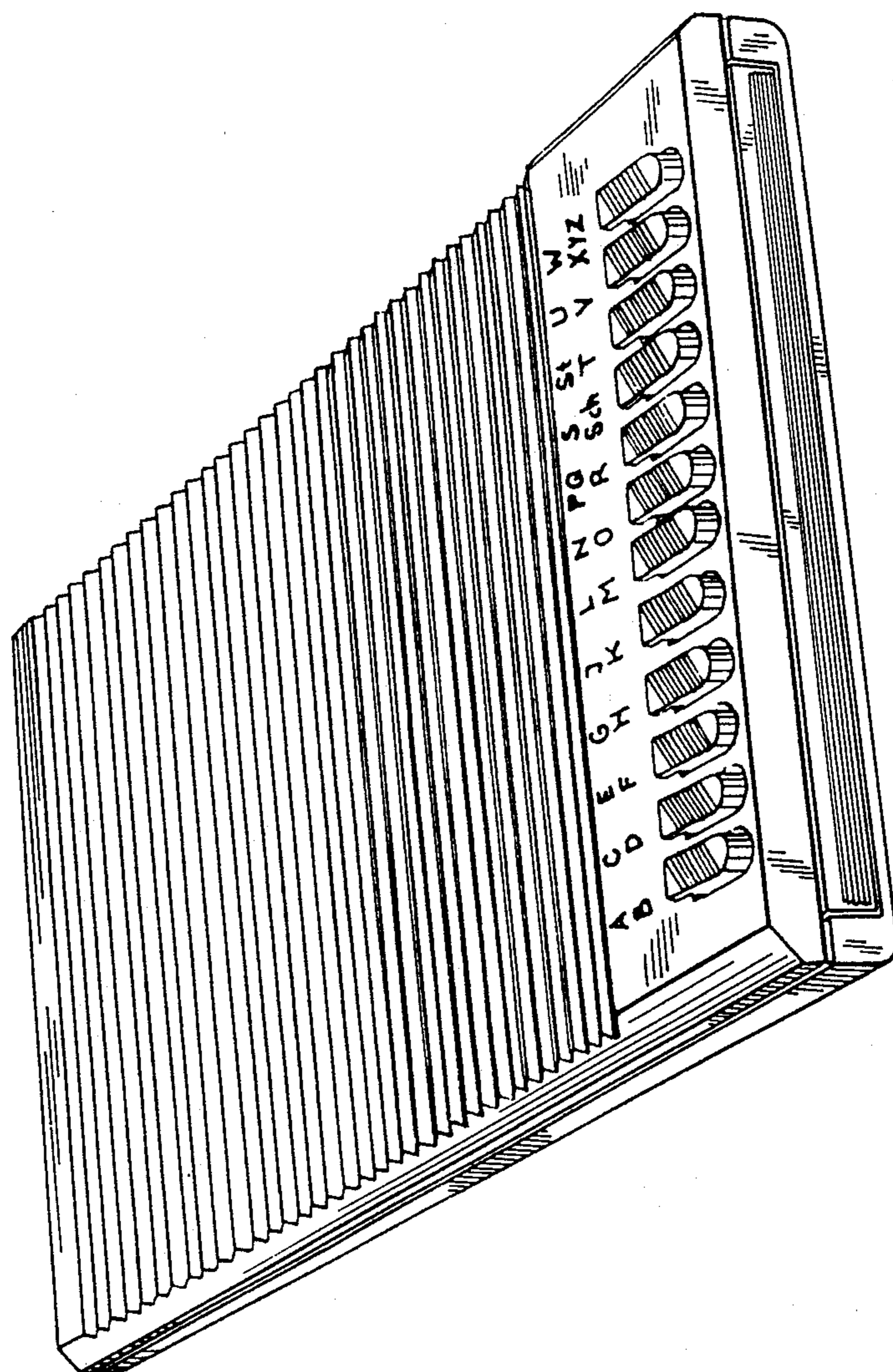

FIG. 8

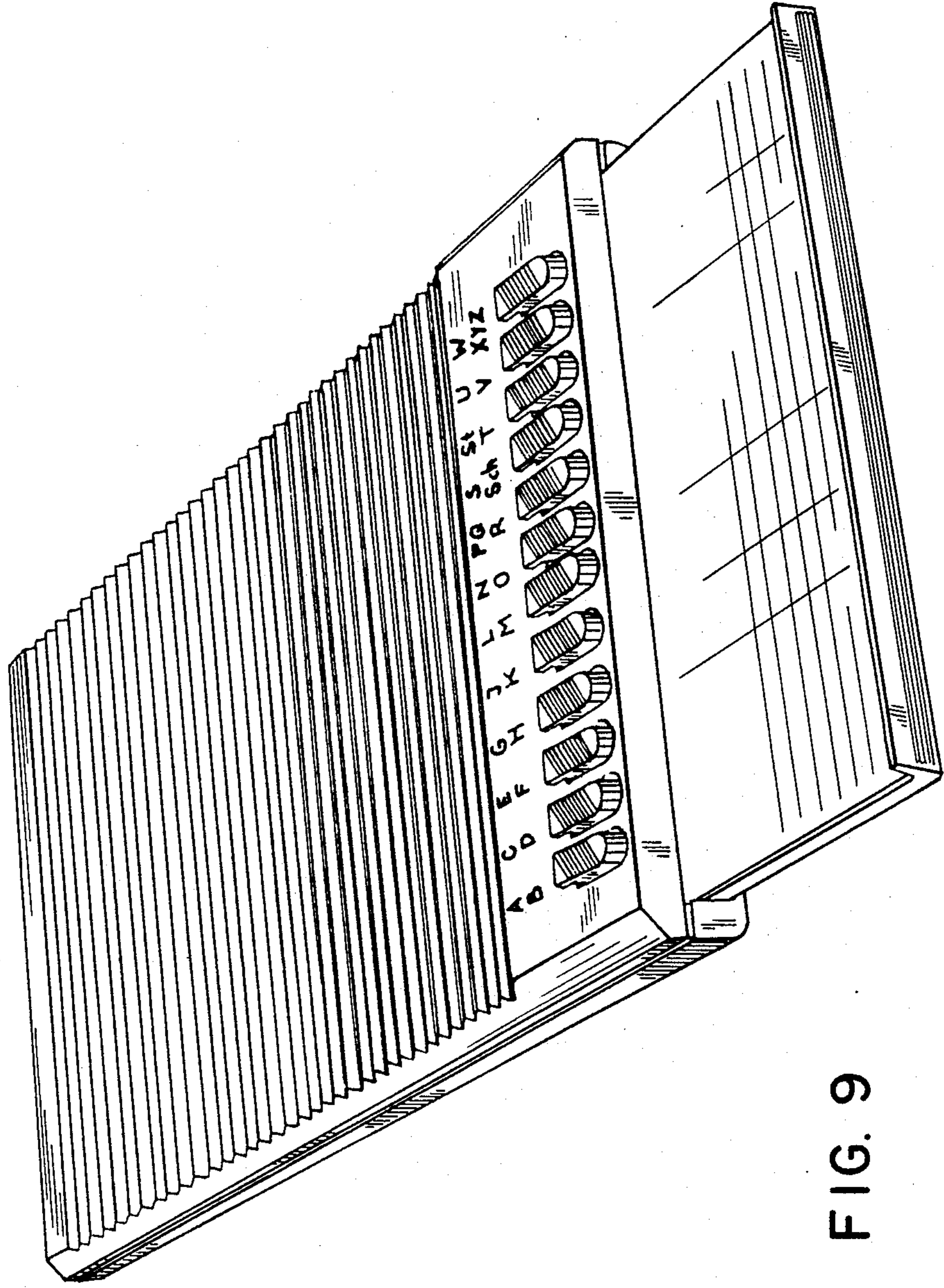

FIG. 9

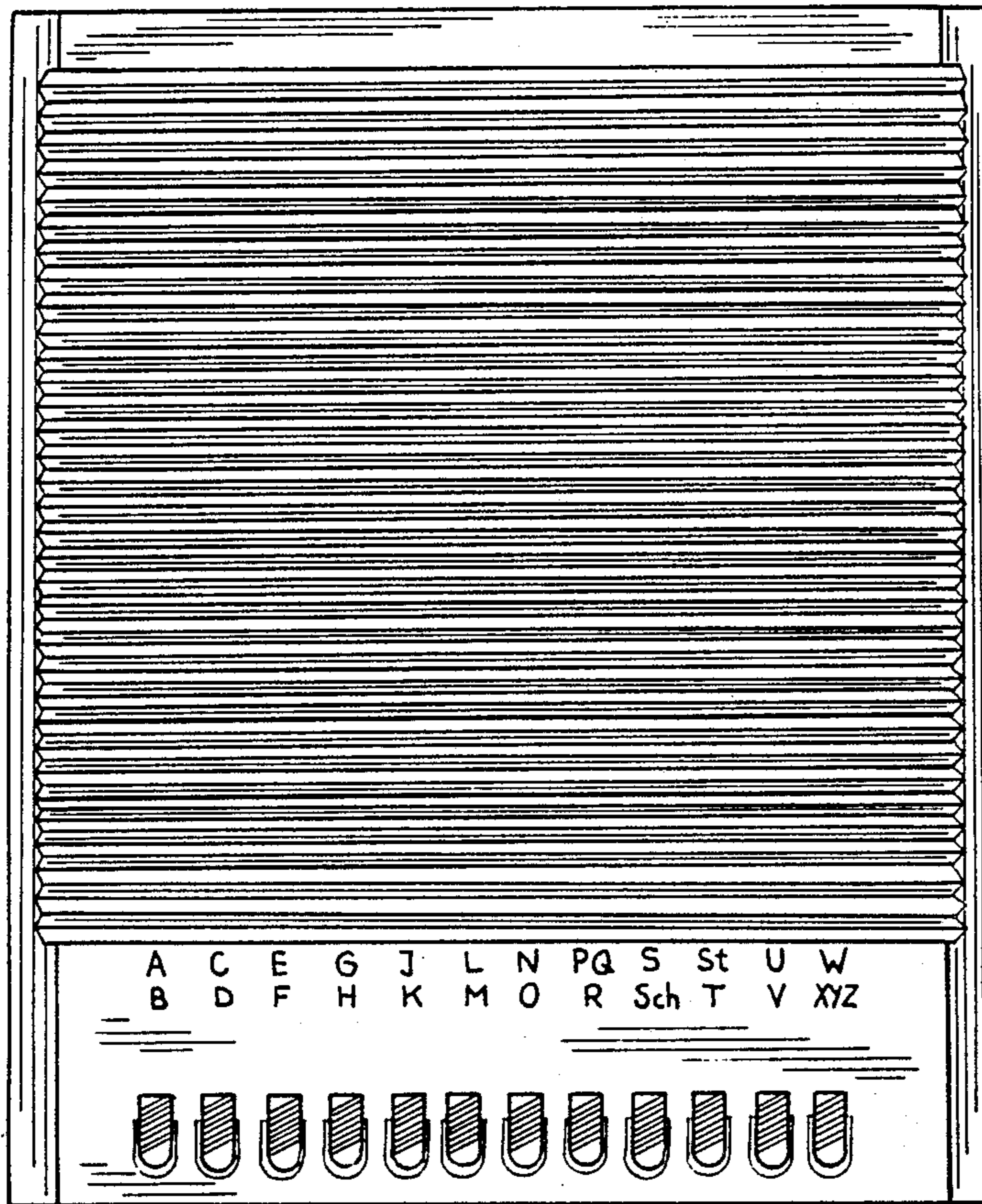

FIG. 10

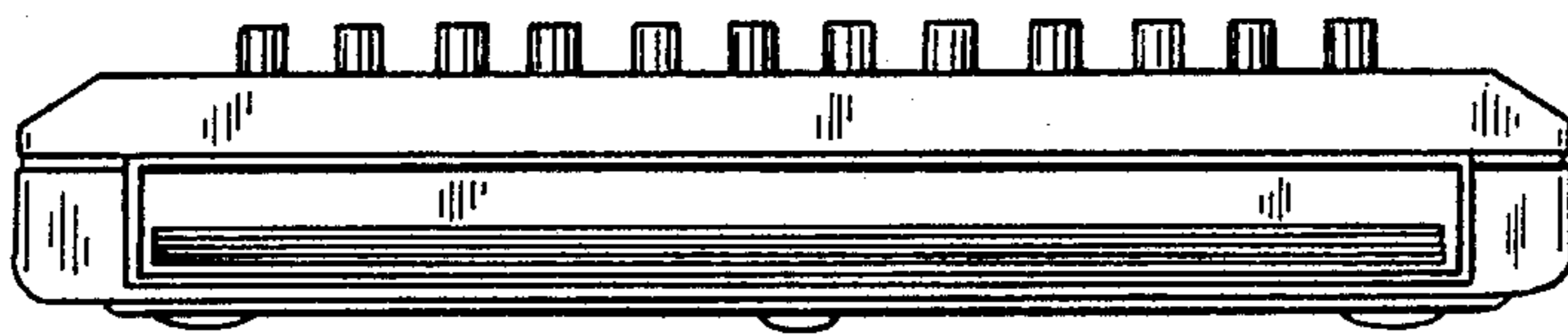

FIG. 11

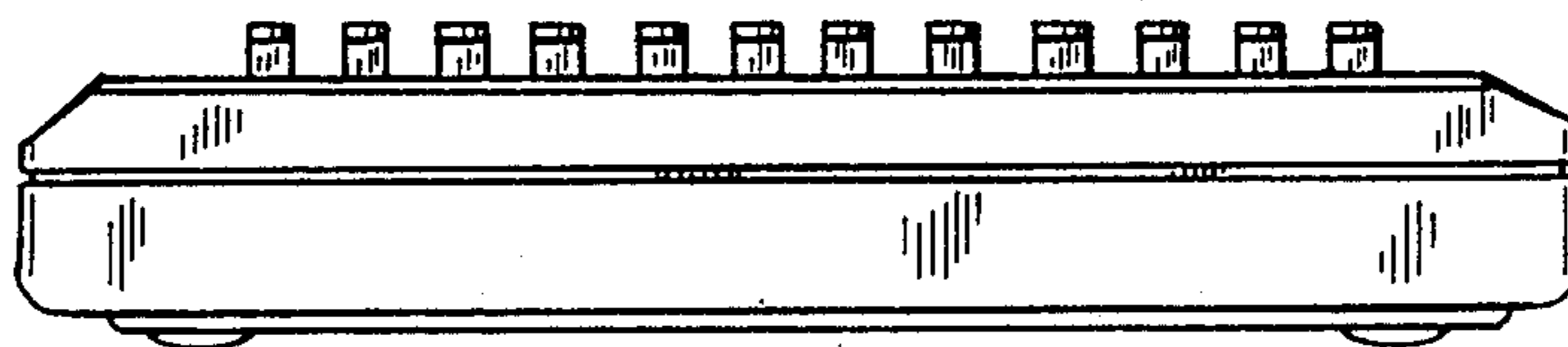

FIG. 12

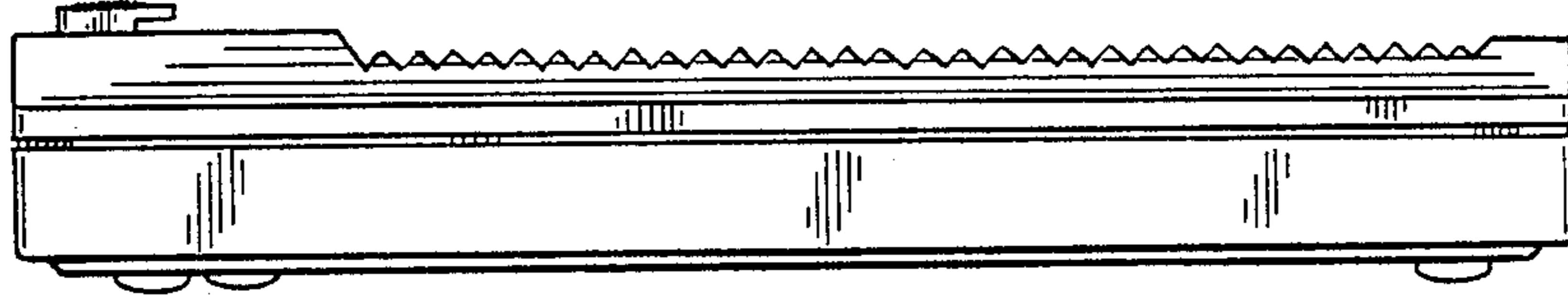

FIG. 13

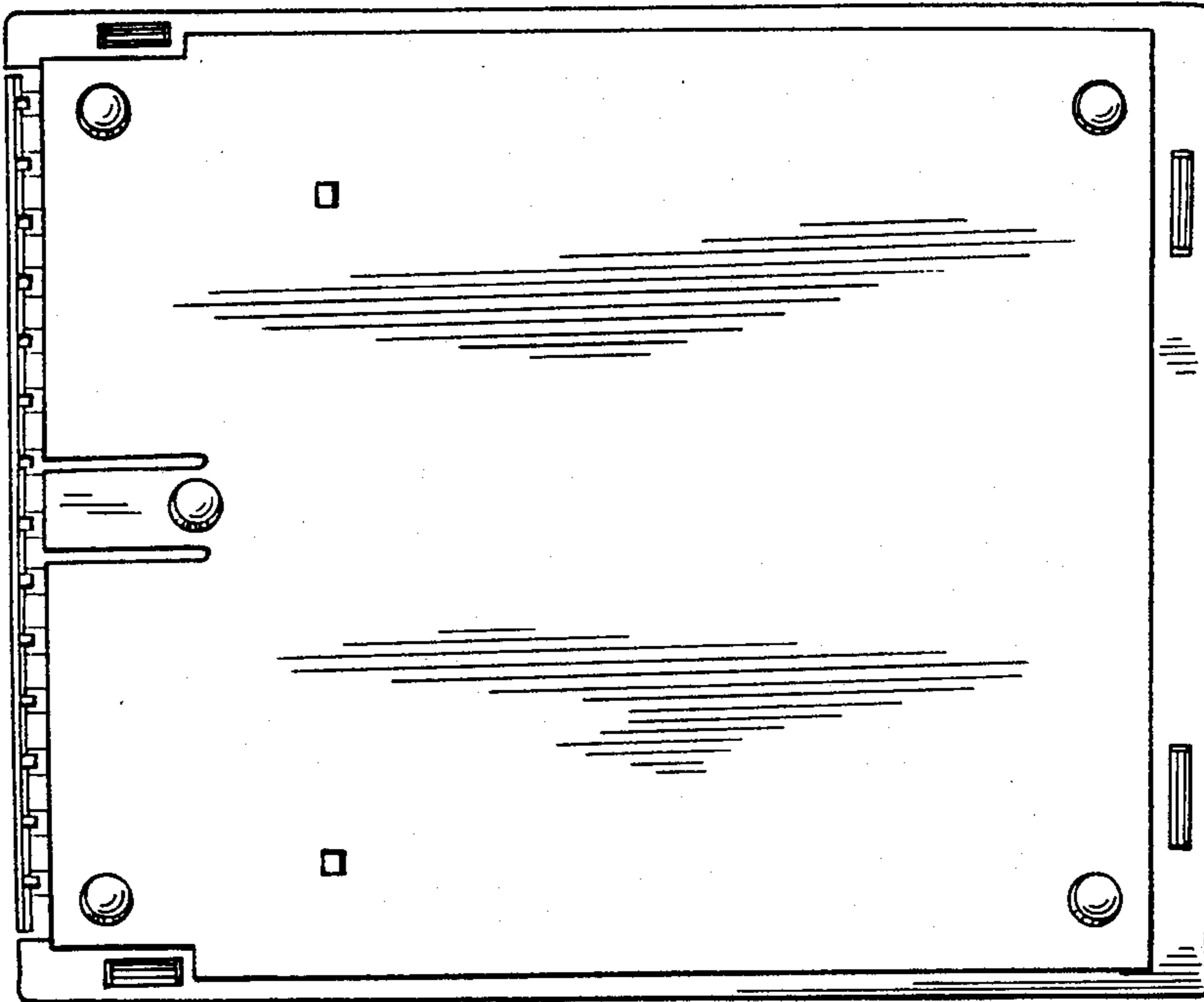

FIG. 14

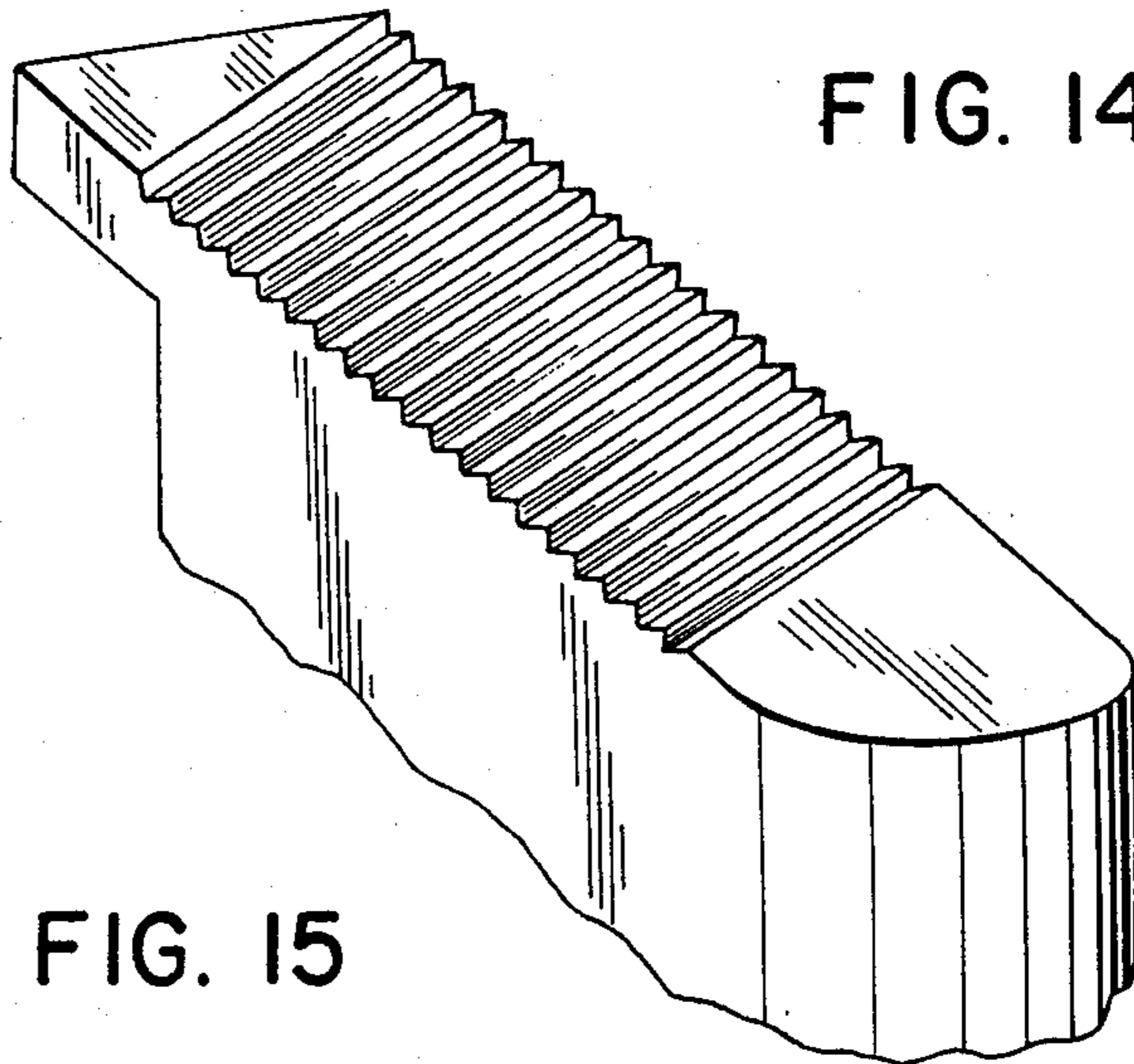

FIG. 15

UNITED STATES PATENT AND TRADEMARK OFFICE
CERTIFICATE OF CORRECTION

PATENT NO. : Des. 313,626
DATED : January 8, 1991
INVENTOR(S) : Hans Halm

It is certified that error appears in the above-identified patent and that said Letters Patent is hereby corrected as shown below: Title page
Item:

[30] Foreign Application Priority Data
Oct. 1, 1986 [DE] Fed. Rep. of Germany...8626166 [U]

Signed and Sealed this
Eighteenth Day of August, 1992

Attest:

DOUGLAS B. COMER

Attesting Officer

Acting Commissioner of Patents and Trademarks