

[54] **BOTTLE**
 [75] **Inventor: Theodore L. Beaver, Roselle, Ill.**
 [73] **Assignee: The Clorox Company, Oakland, Calif.**
 [*] **Notice: The portion of the term of this patent subsequent to Jan. 1, 2005 has been disclaimed.**
 [**] **Term: 14 Years**
 [21] **Appl. No.: 110,384**
 [22] **Filed: Oct. 19, 1987**
 [52] **U.S. Cl. D9/376**
 [58] **Field of Search D9/376, 378, 375; 215/1 R, 1 C, 100 A**

279,453 7/1985 Beechuk et al. D9/376
 280,488 9/1985 Lane et al. D9/376
 D. 289,611 5/1987 Seelig D9/376
 D. 291,965 9/1987 Best D9/376
 D. 302,246 7/1989 Ross D9/376
 D. 305,407 1/1990 Gonda D9/376
 4,269,722 5/1981 Joshi et al. .

FOREIGN PATENT DOCUMENTS

MR27138 2/1987 Fed. Rep. of Germany .

OTHER PUBLICATIONS

Packaging Technology, Feb., 1985, pp. 1, 8, 12.

Primary Examiner—Melvin B. Feifer
Assistant Examiner—Lucy Lieberman
Attorney, Agent, or Firm—Joel J. Hayashida; Michael J. Mazza; Stephen M. Westbrook

[56] **References Cited**
U.S. PATENT DOCUMENTS

D. 197,581 2/1964 Trombly et al. .
 D. 209,929 1/1968 Plummer D9/378
 210,113 2/1968 Gantz et al. .
 216,583 2/1970 Coghill .
 D. 218,219 8/1970 Hills .
 218,801 9/1979 Hills .
 220,609 5/1971 Dickins .
 223,601 5/1972 Johnson .
 223,807 6/1972 Thomson .
 D. 224,201 7/1972 Beaver .
 D. 231,647 5/1974 Morino D9/376
 232,419 8/1974 Luedtke .
 247,347 2/1978 Klingaman .
 252,795 9/1979 Campbell .
 257,952 1/1981 Torongo, Jr. D9/376
 260,857 9/1981 Pardo D9/376
 269,949 8/1983 Stoy D9/376
 277,733 2/1985 Aldrich et al. D9/376

[57] **CLAIM**

The ornamental design for a bottle, as shown and described.

DESCRIPTION

FIG. 1 is a front elevational view of a bottle embodying my new design;
 FIG. 2 is a side elevational view looking from the right of FIG. 1, the opposite side being a mirror image thereof;
 FIG. 3 is a rear elevational view thereof;
 FIG. 4 is a top plan view thereof;
 FIG. 5 is a sectional view taken along line 5—5 of FIG. 2.
 FIG. 6 is a bottom plan view thereof; and
 FIG. 7 is a rear elevational view of the bottle shown with the handle portion thereof partially in section taken along lines 7—7 of FIG. 2.

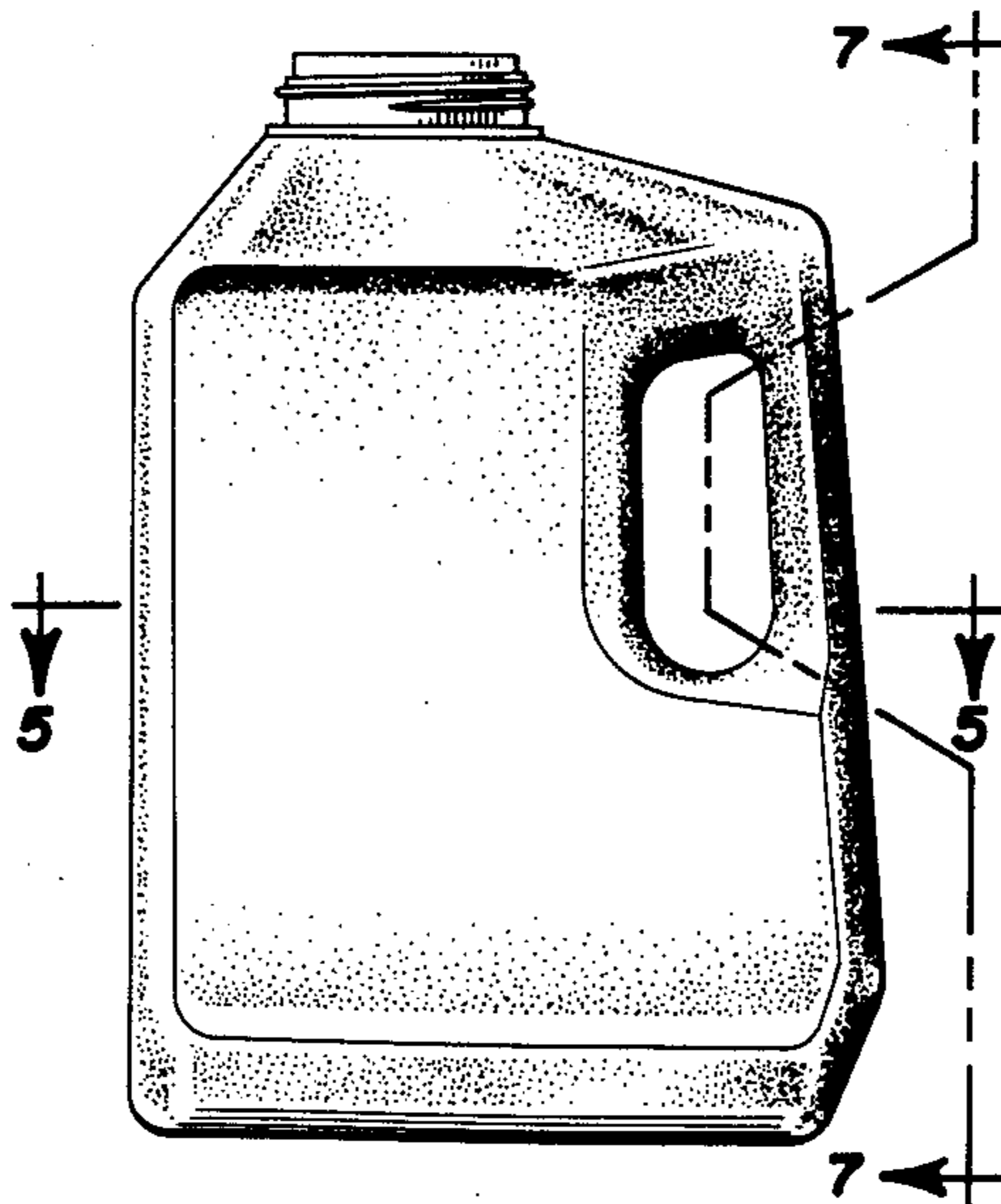

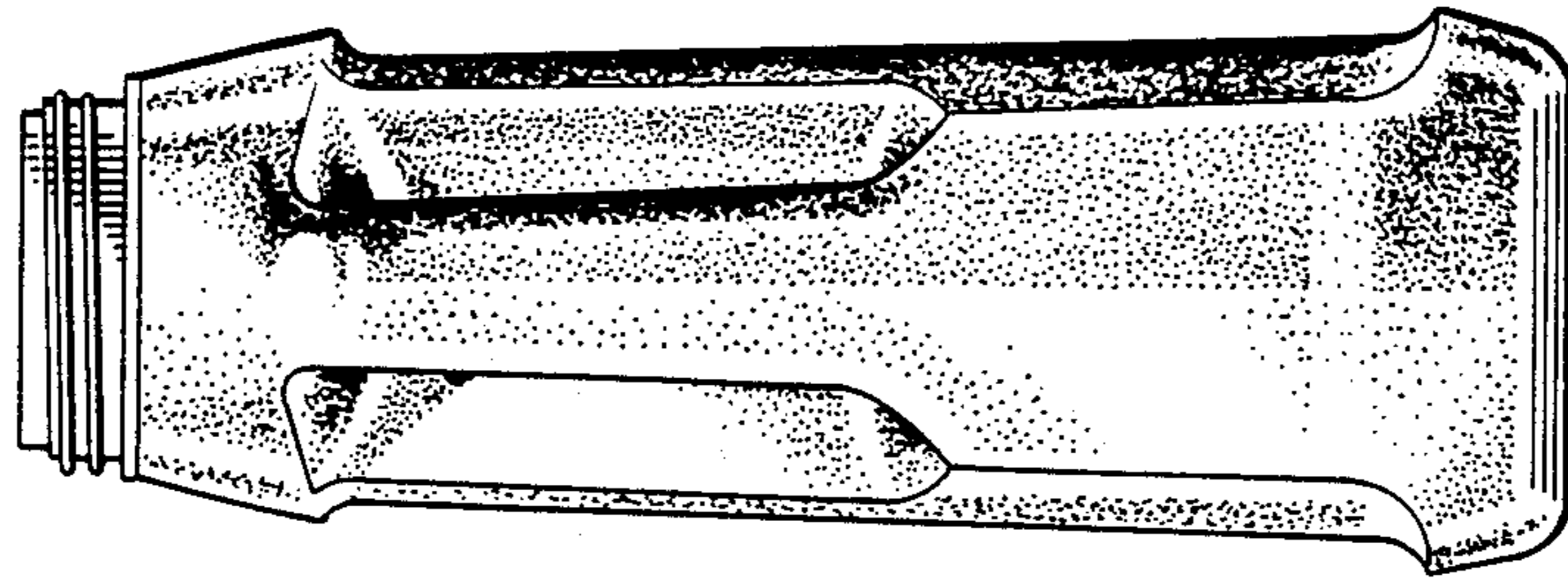

FIGURE 3

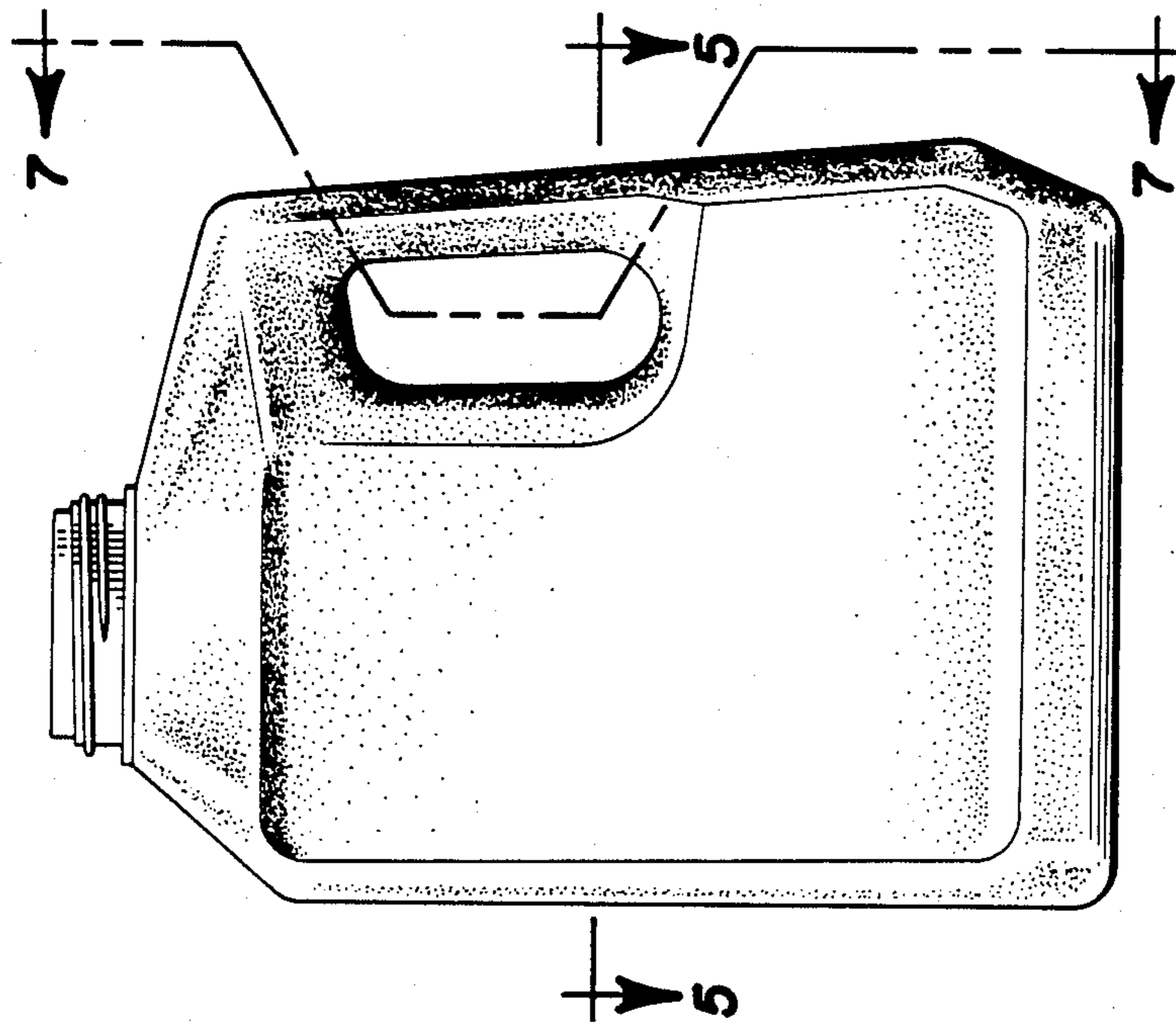

FIGURE 2

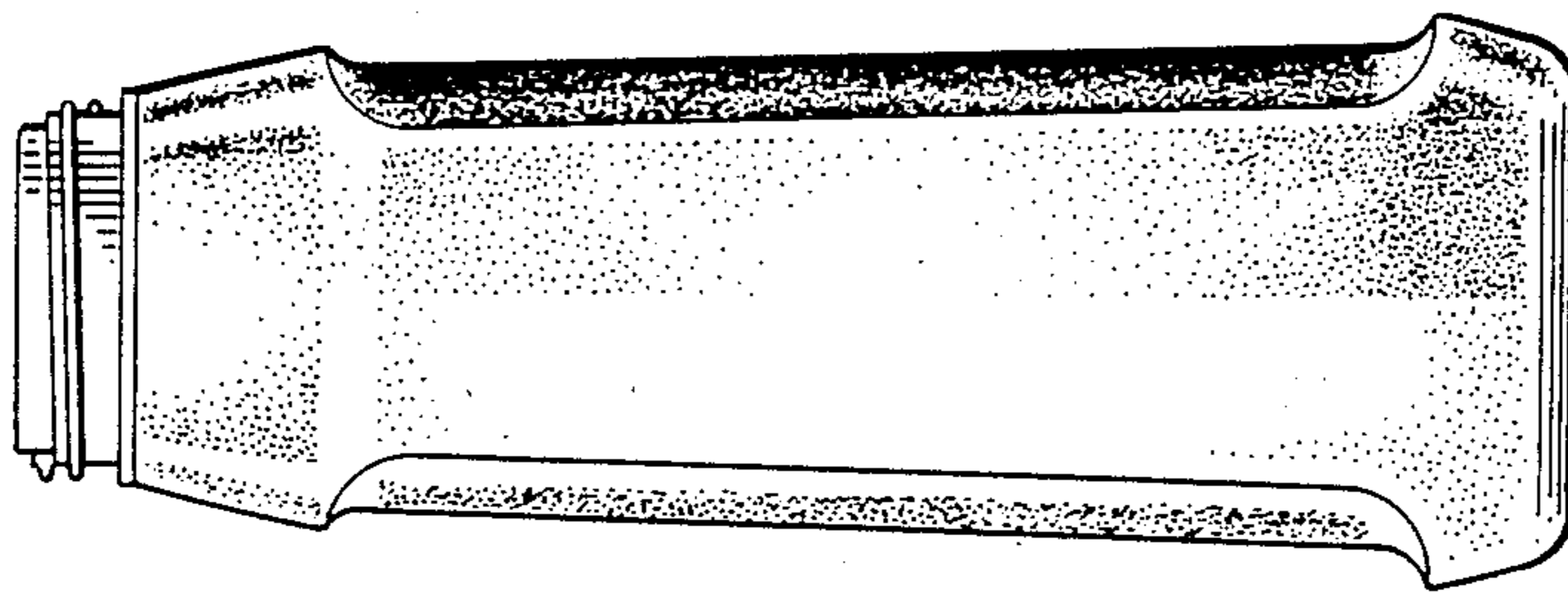

FIGURE 1

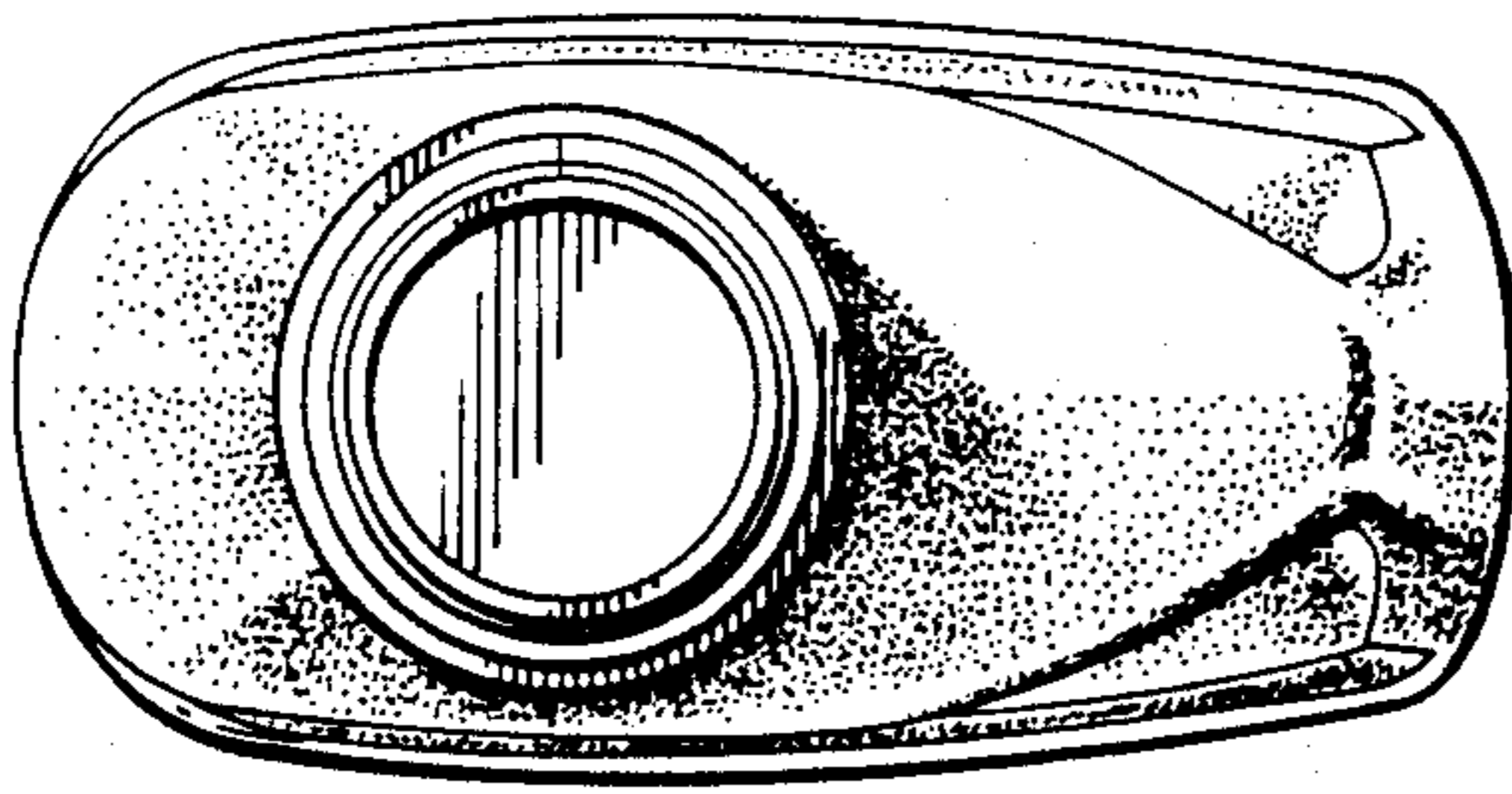

FIGURE 4

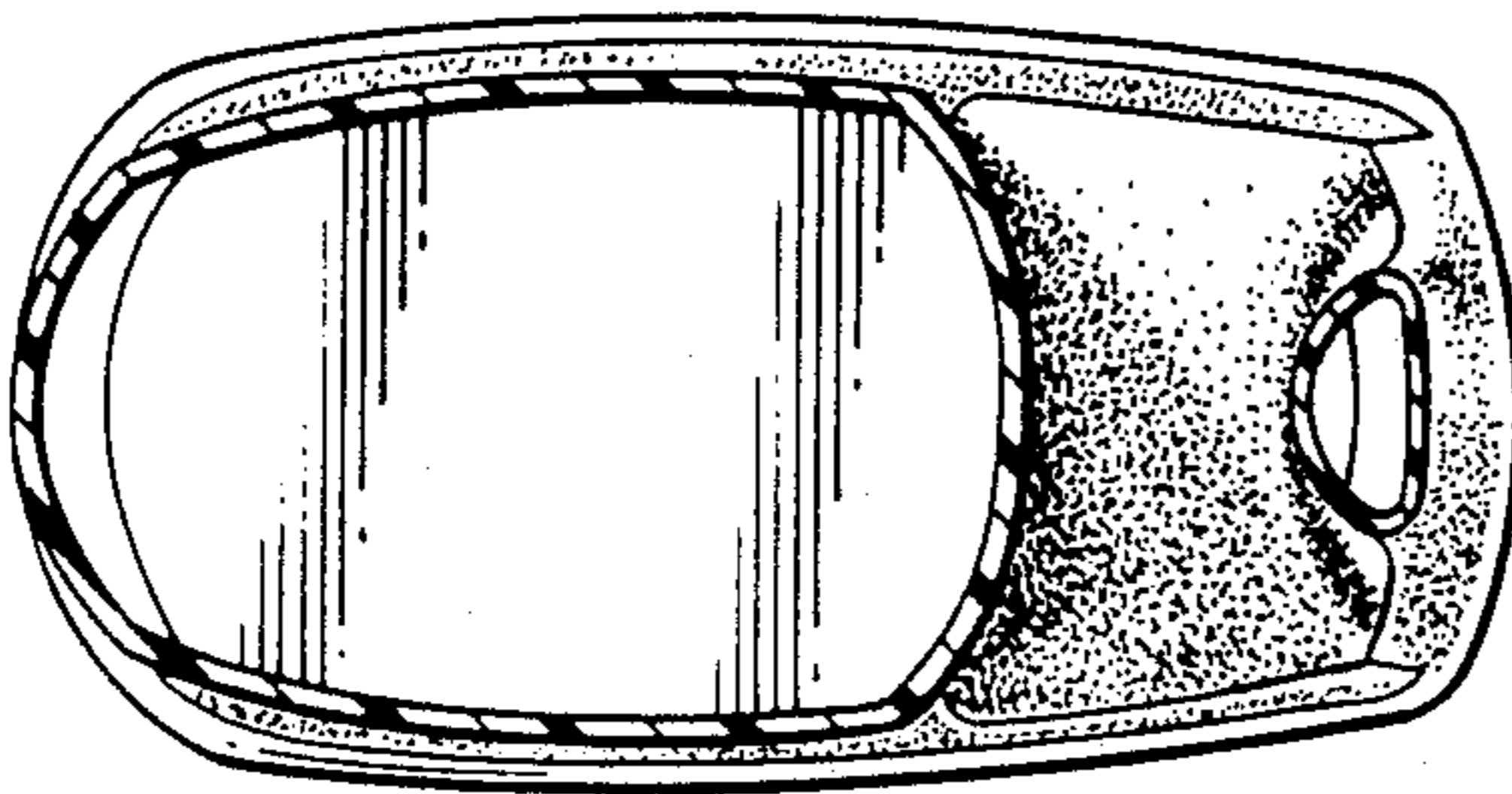

FIGURE 5

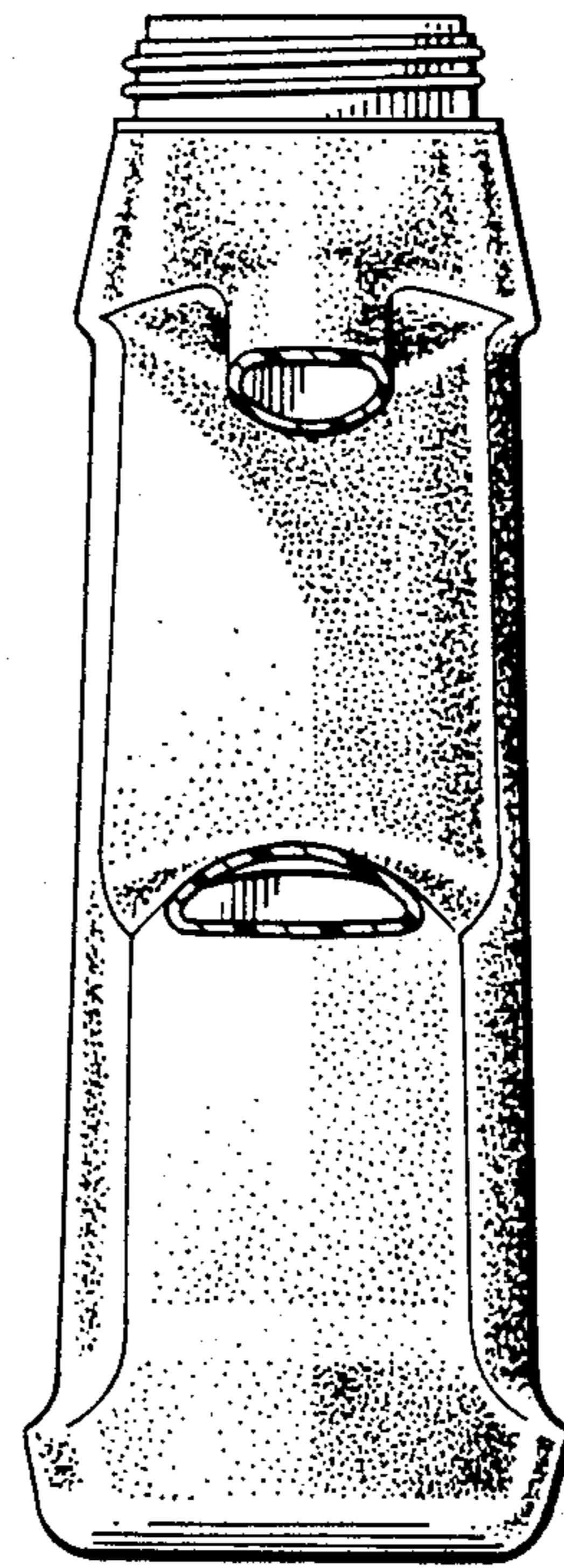

FIGURE 7

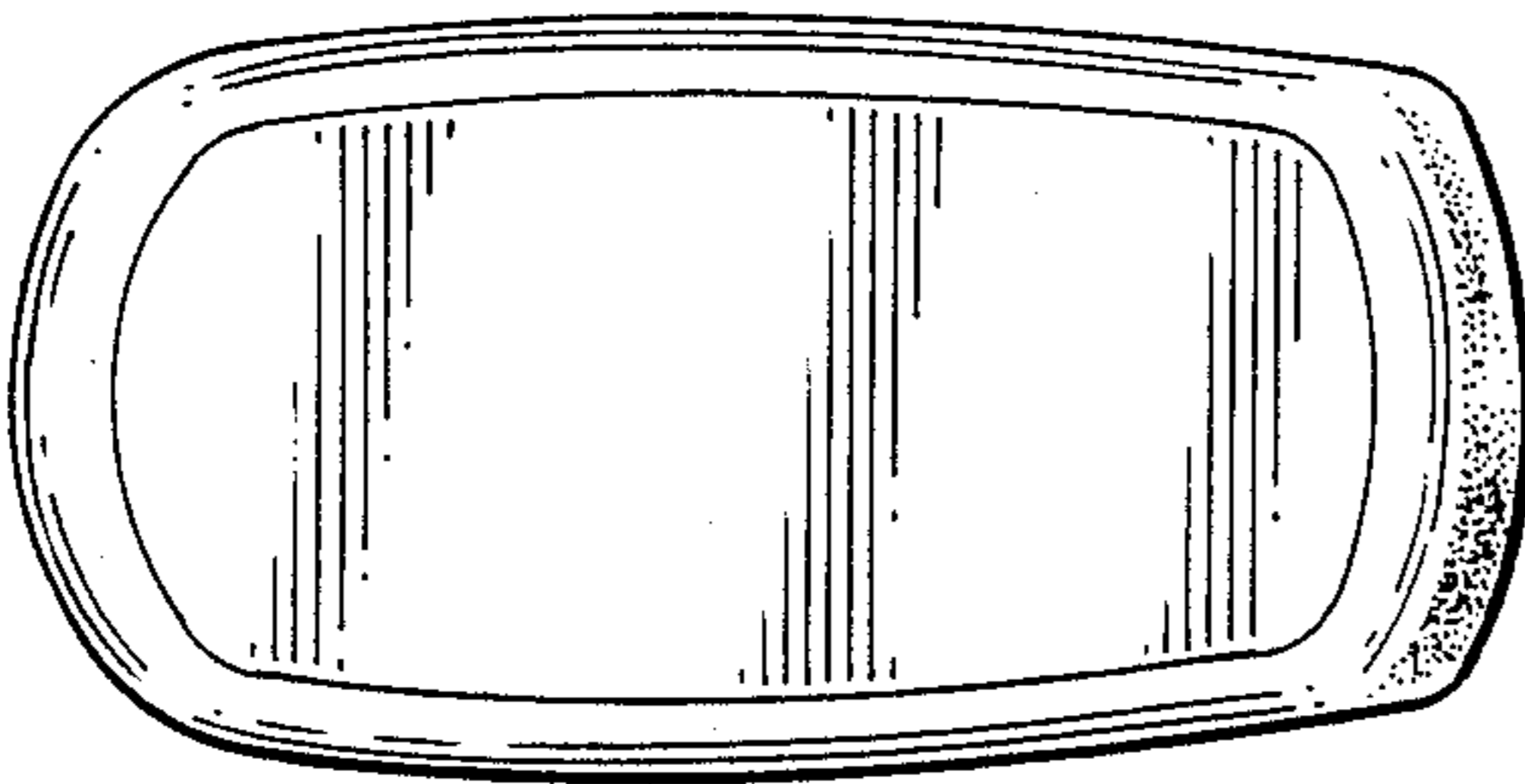

FIGURE 6