

[54] HEATER

[76] Inventor: Hans U. Schade, Uhlandstrasse 2, 7914 Pfuhl 2, Fed. Rep. of Germany

[\*\*] Term: 14 Years

[21] Appl. No.: 276,428

[22] Filed: Nov. 23, 1988

[30] Foreign Application Priority Data

May 25, 1988 [DE] Fed. Rep. of Germany ... MRVII456

[52] U.S. Cl. .... D23/332

[58] Field of Search ..... 219/339, 342, 359, 366, 219/367, 368, 369, 344, 348; D23/332, 370, 337, 335

[56] References Cited

U.S. PATENT DOCUMENTS

D. 102,667 1/1937 MacDonald ..... D23/370  
3,059,090 10/1962 Waters ..... 219/368

Primary Examiner—James M. Gandy

Assistant Examiner—Lisa Lichtenstein  
Attorney, Agent, or Firm—Collard, Roe & Galgano

[57] CLAIM

The ornamental design for a heater, as shown.

DESCRIPTION

FIG. 1 is a front elevational view of a heater embodying my new design;  
FIG. 2 is a left side elevational view thereof;  
FIG. 3 is a top plan view thereof;  
FIG. 4 is a rear elevational view thereof;  
FIG. 5 is a right side elevational view thereof;  
FIG. 6 is a bottom plan view thereof;  
FIG. 7 is a front elevational view thereof with the lower control drawer in open position;  
FIG. 8 is a top plan view thereof;  
FIG. 9 is a right side elevational view thereof;  
FIG. 10 is a left side elevational view thereof;  
FIG. 11 is a bottom plan view thereof; and  
FIG. 12 is an enlarged front perspective view thereof with the front louvers in open position and the heater tilted backwards on its base.

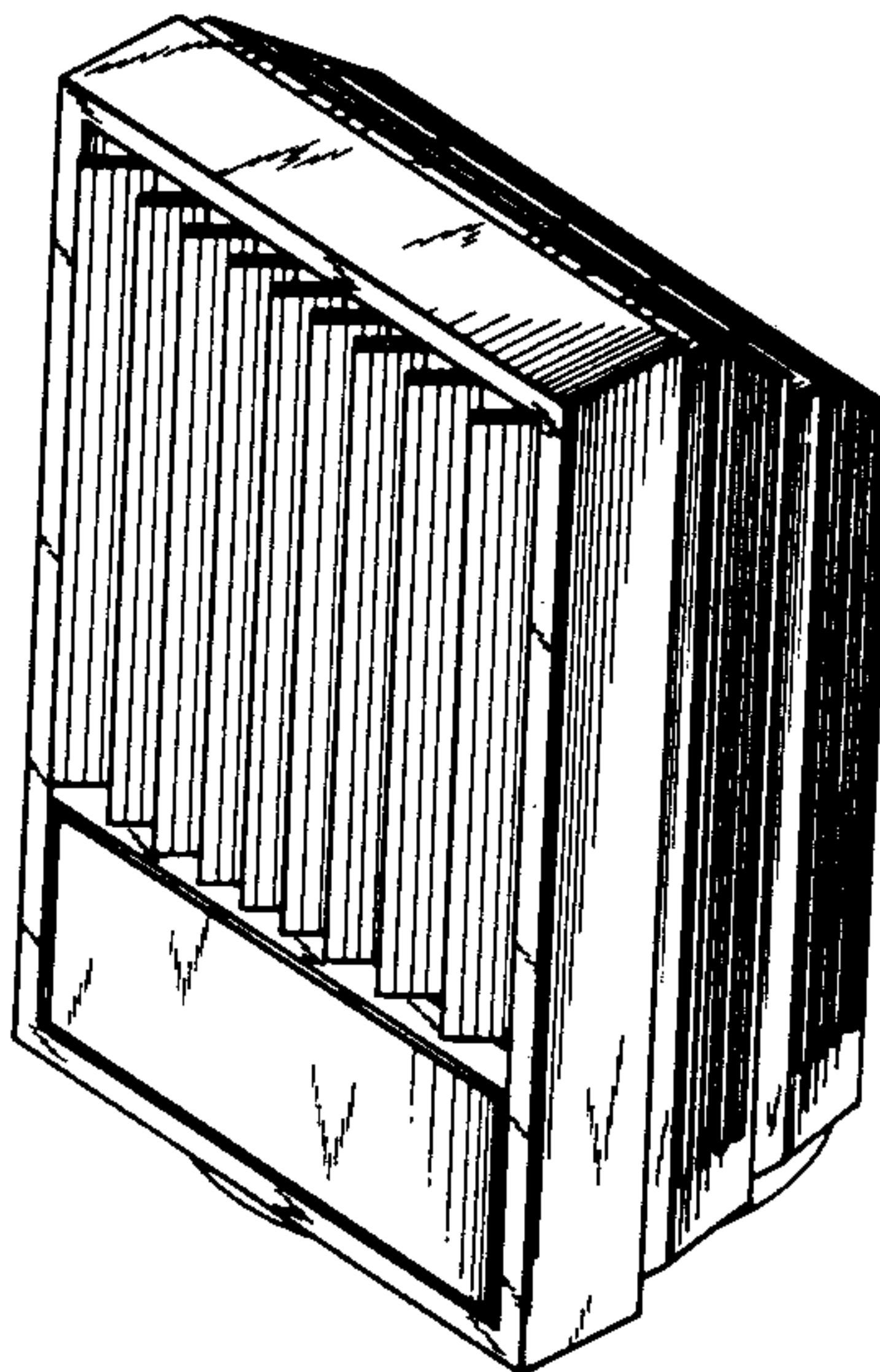

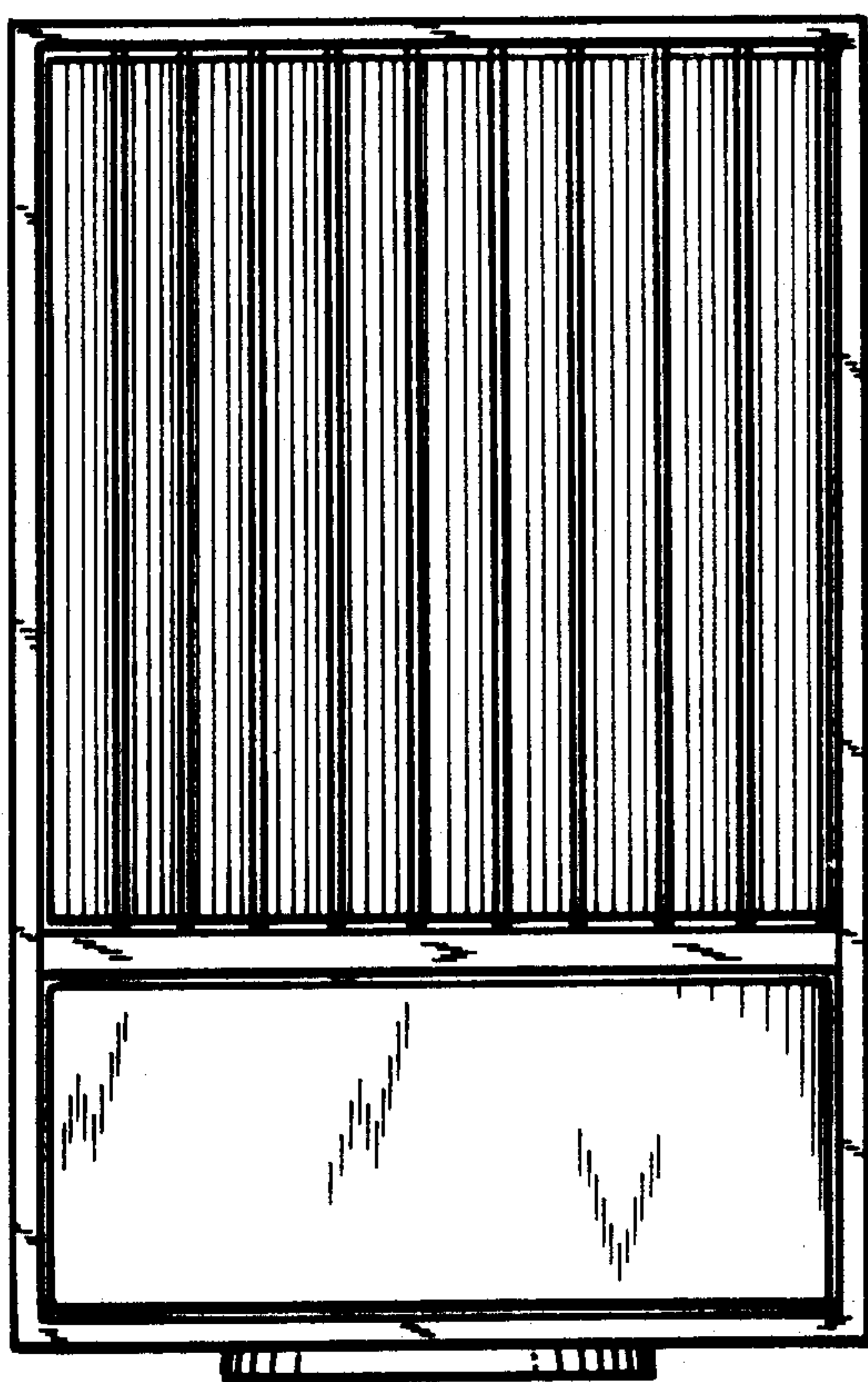

FIG. 1

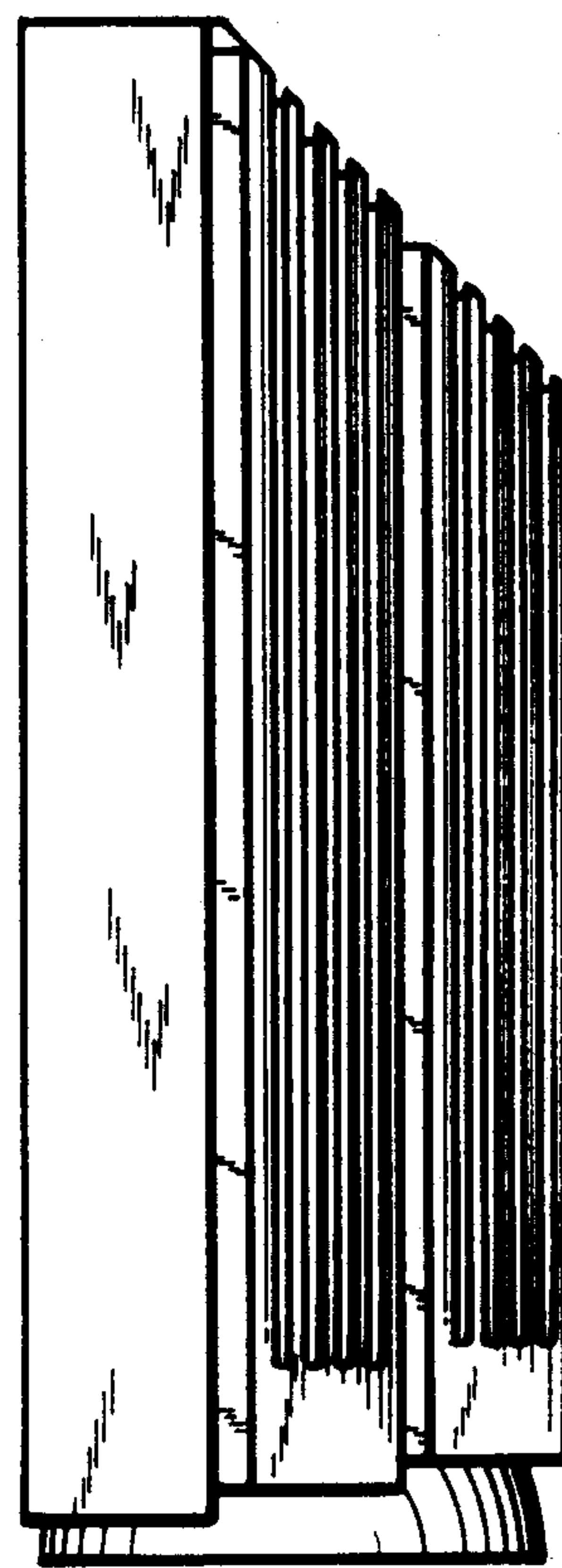

FIG. 2

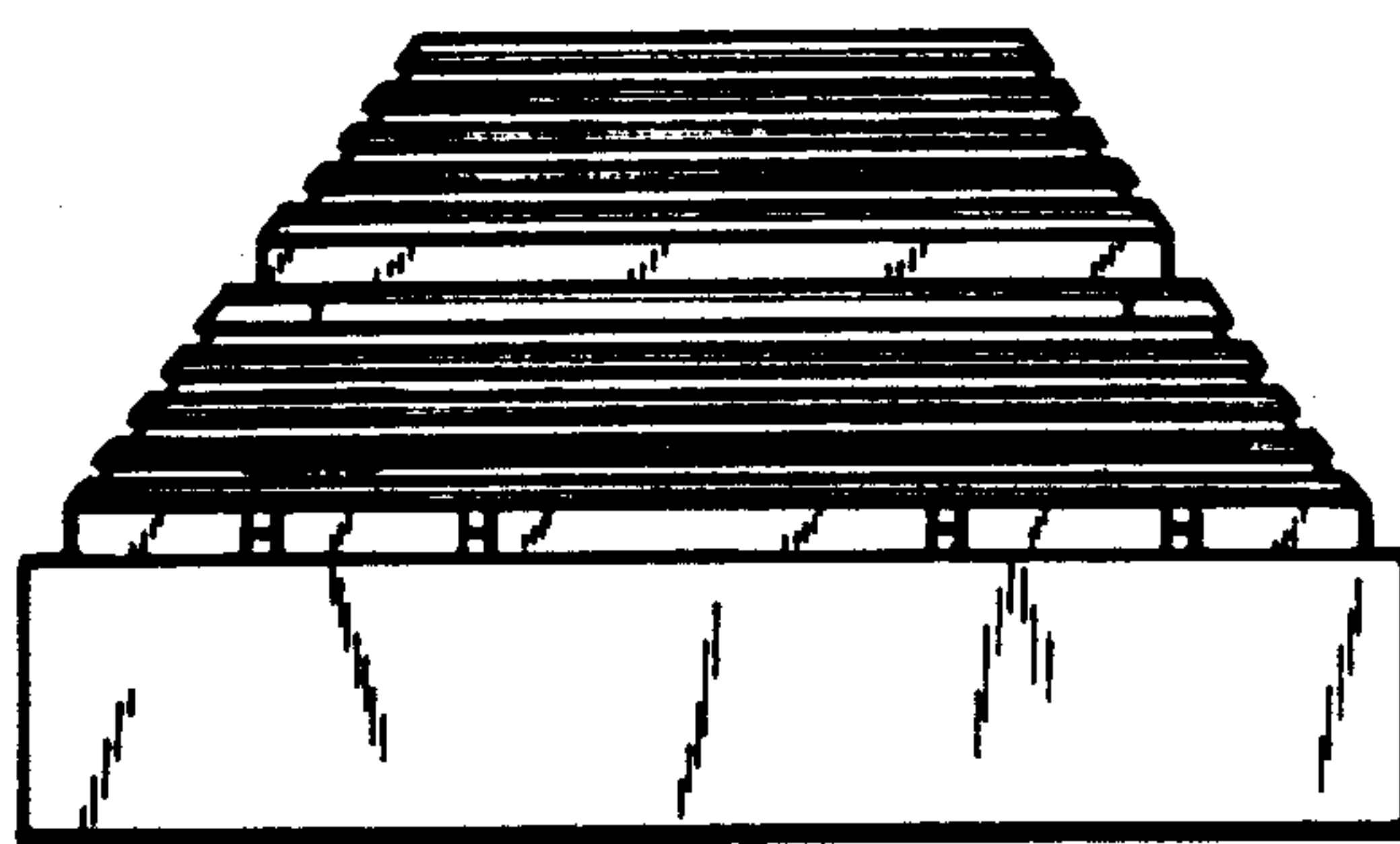

FIG. 3

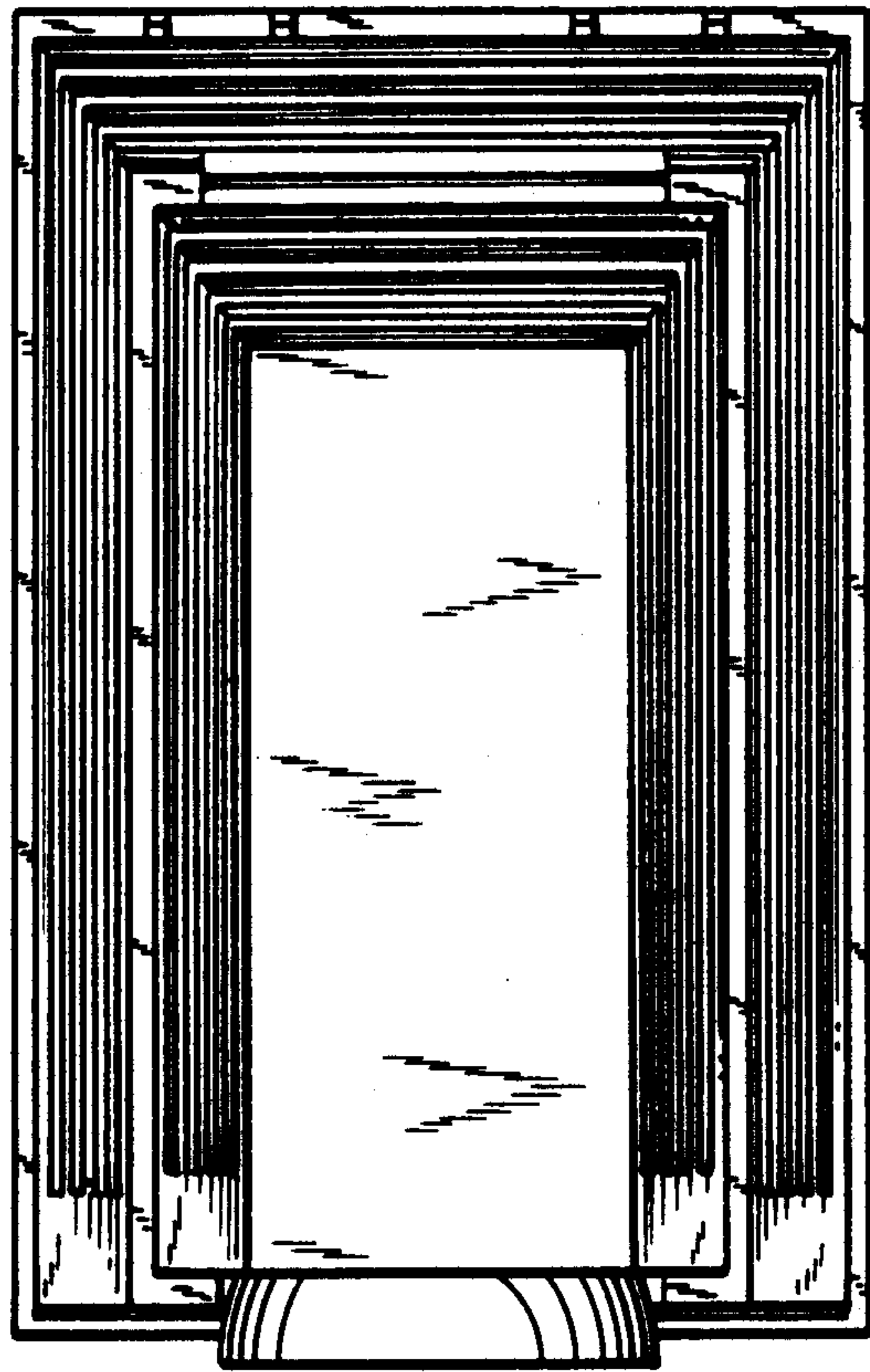

FIG. 4

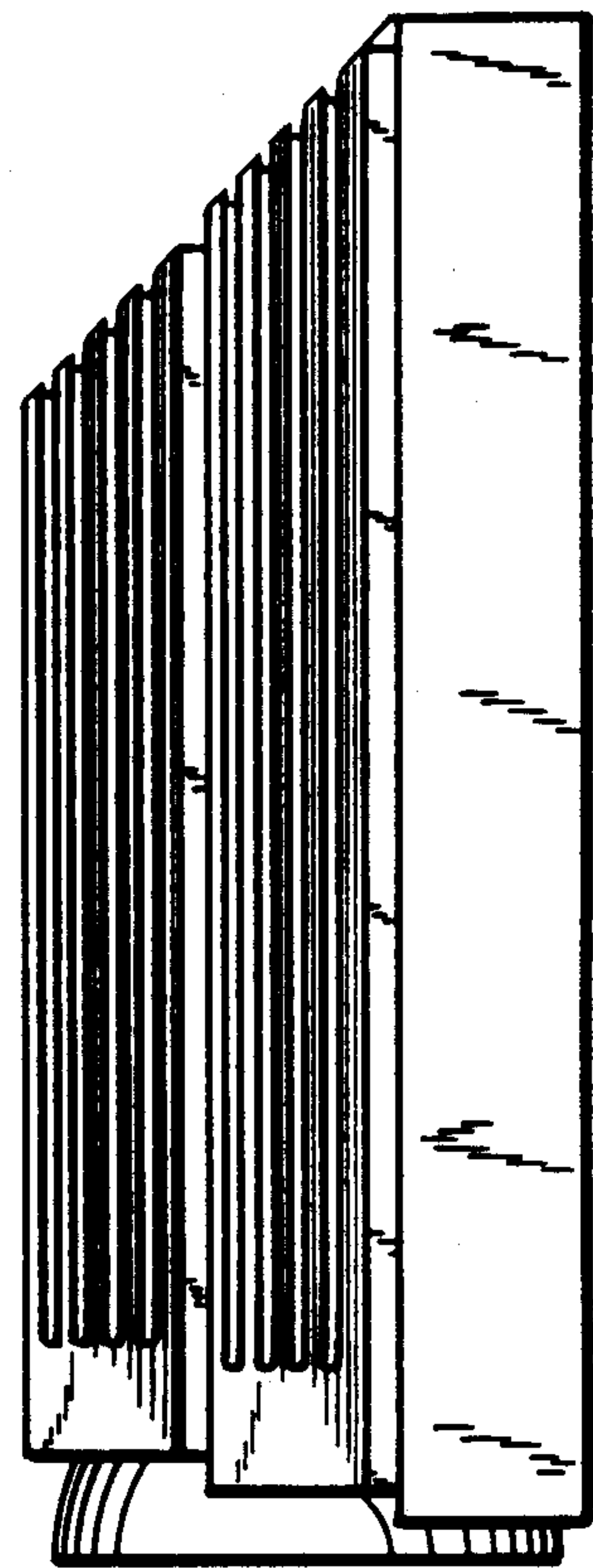

FIG. 5

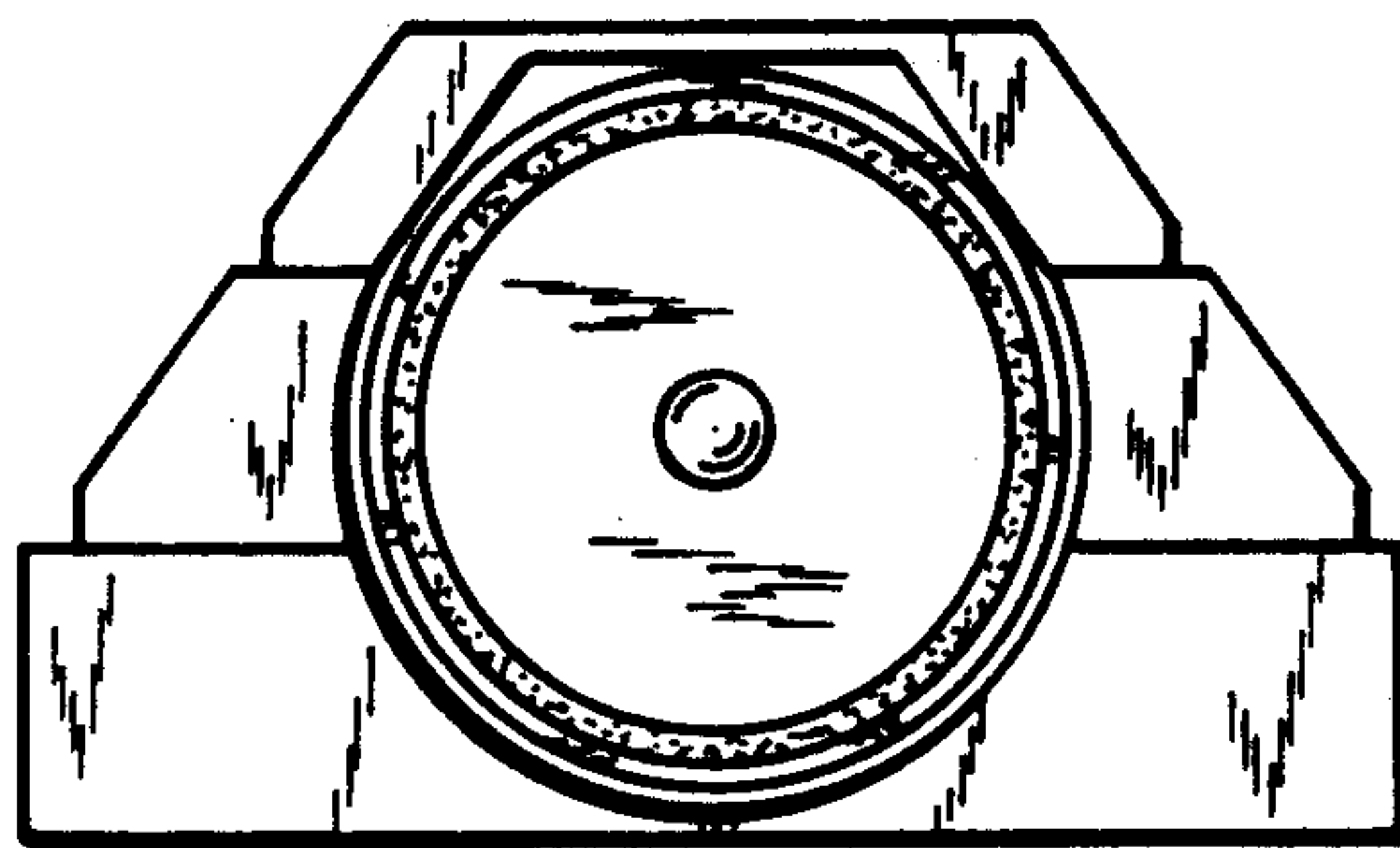

FIG. 6

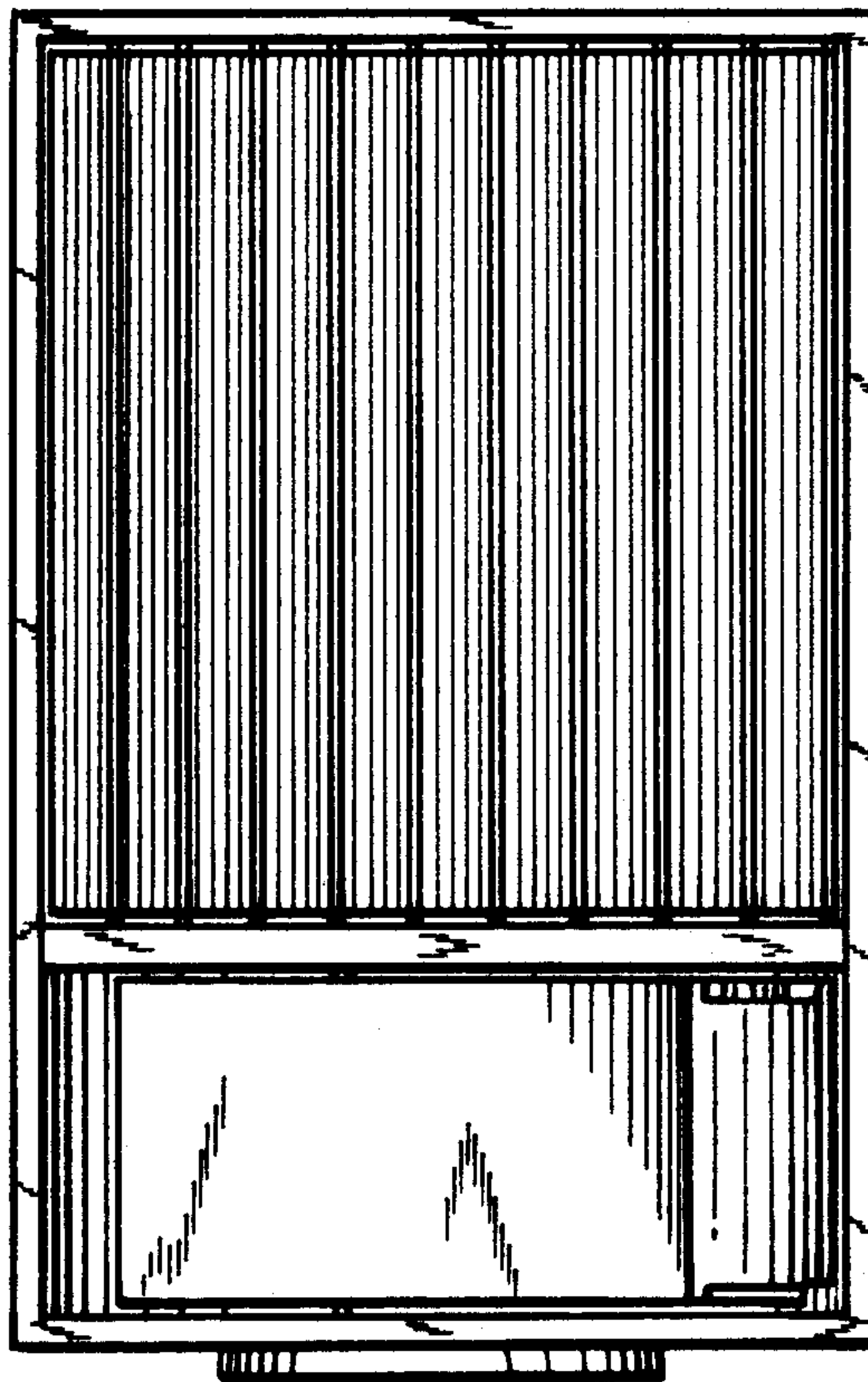

FIG. 7

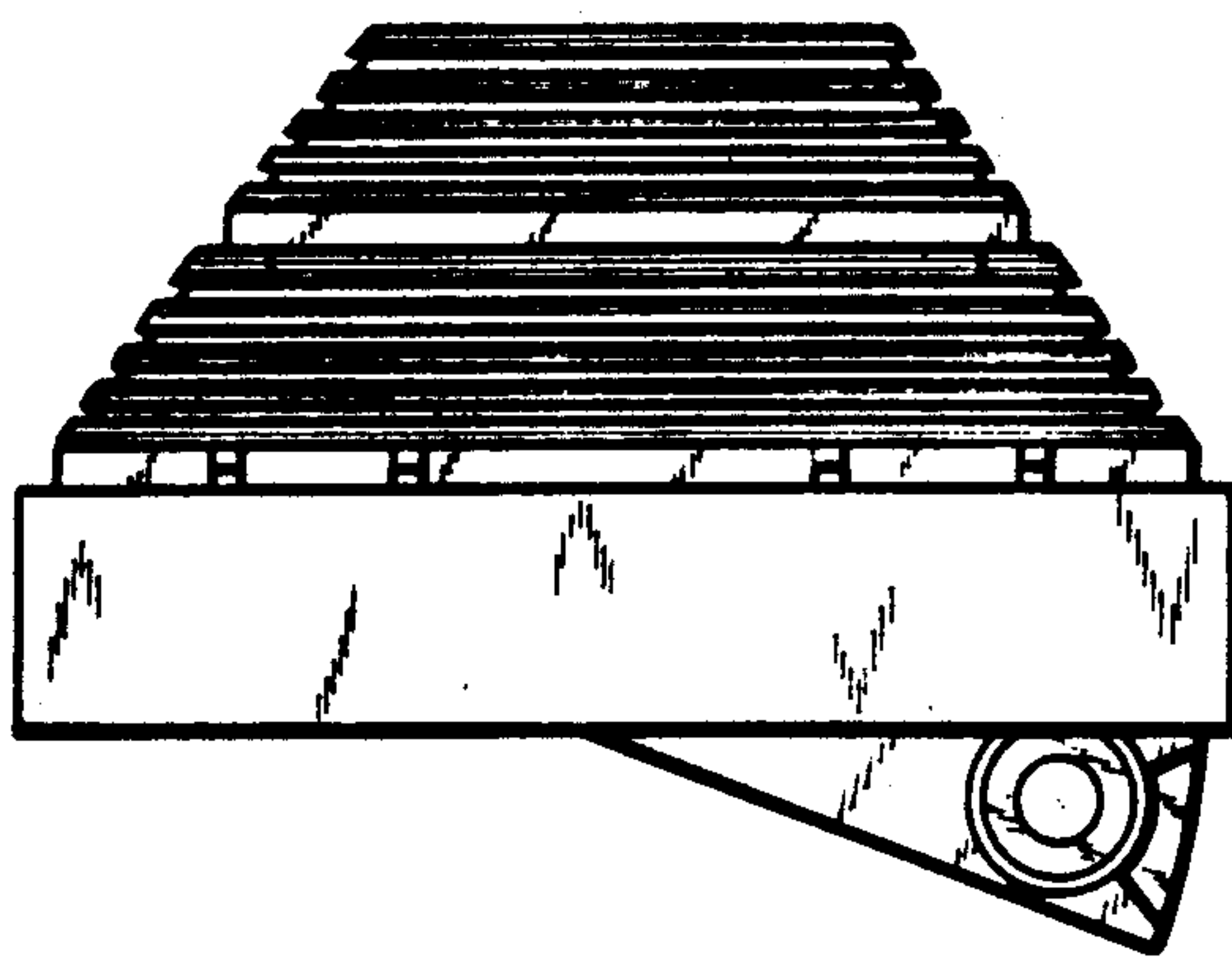

FIG. 8

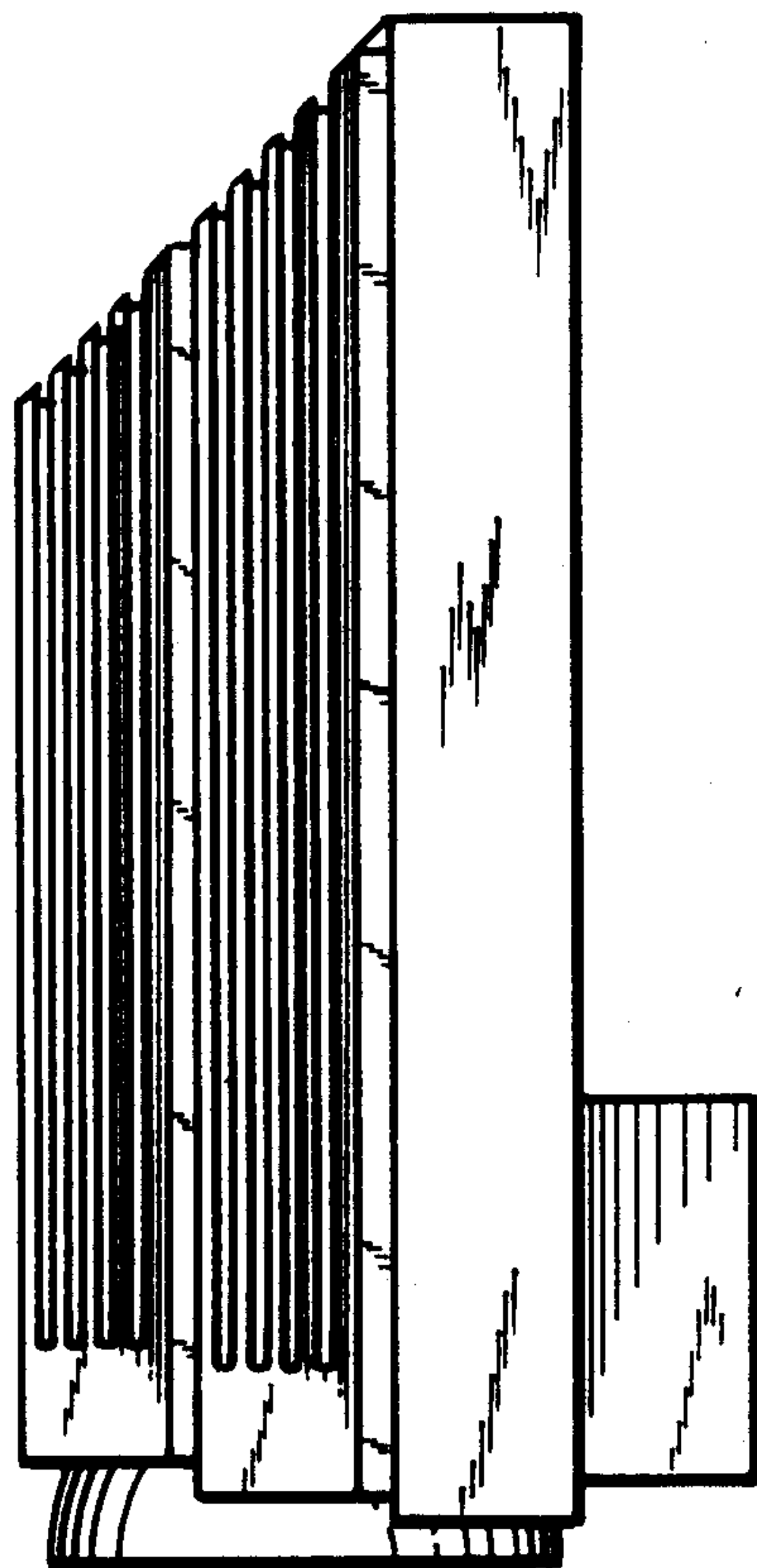

FIG. 9

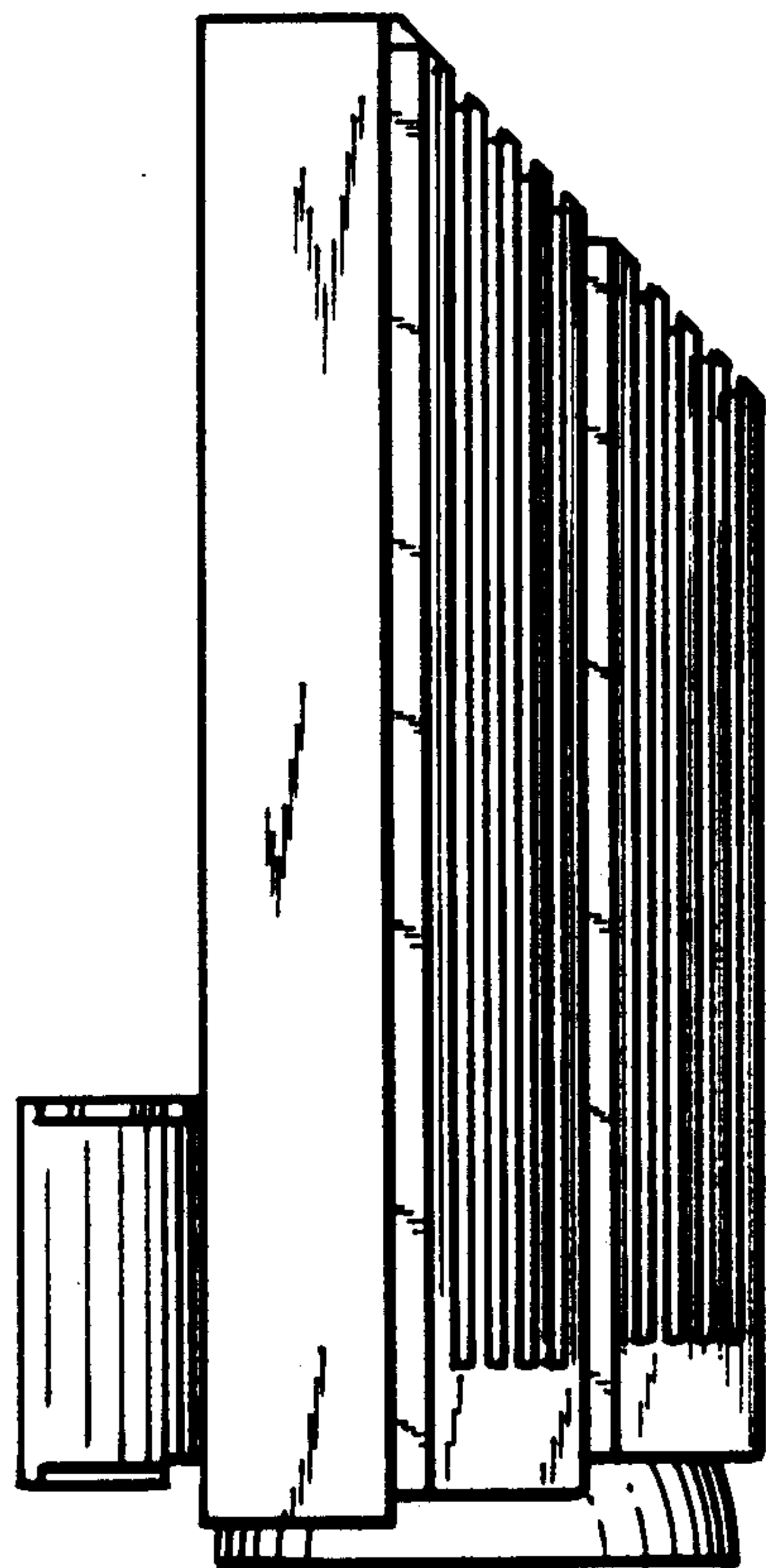

FIG. 10

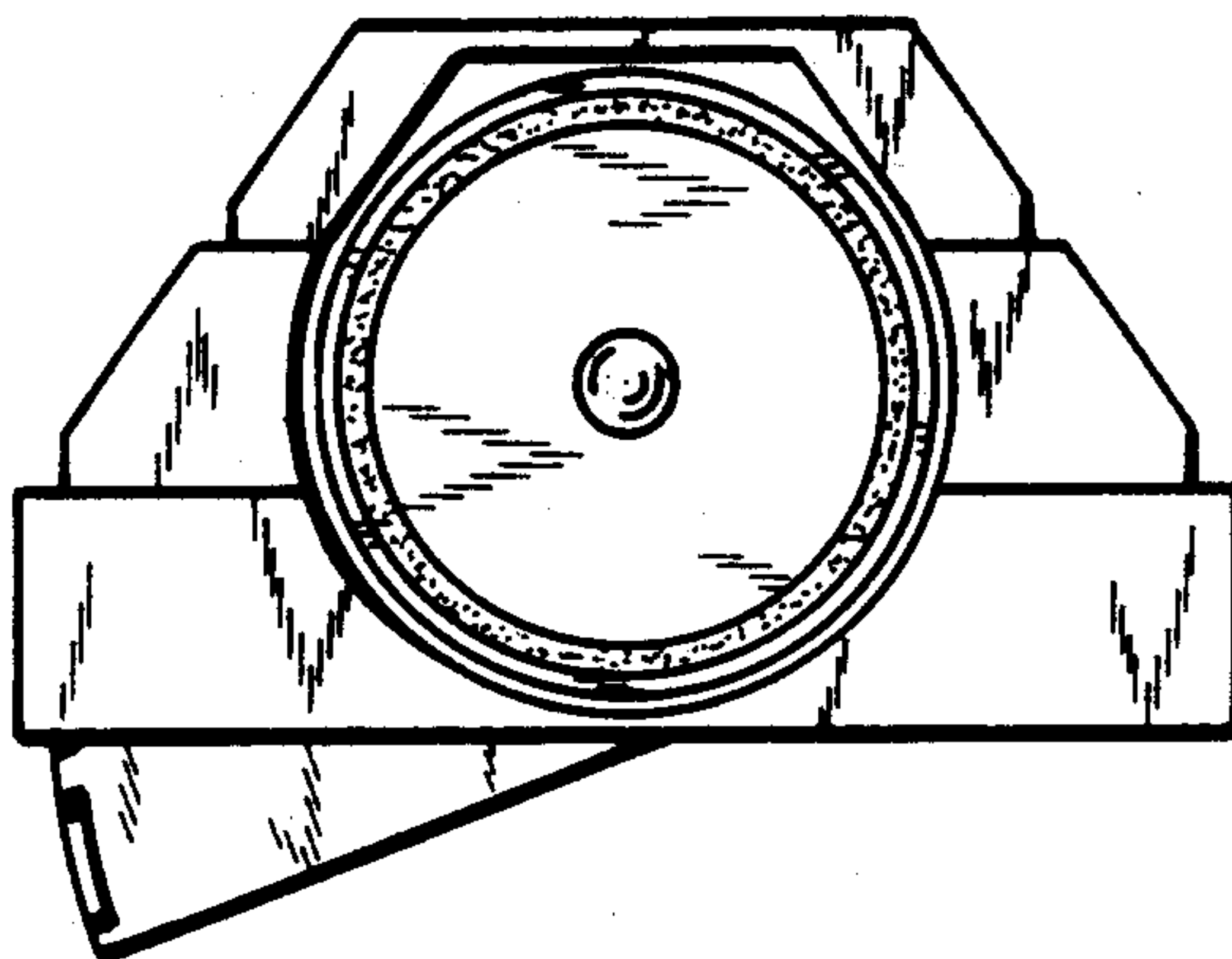

FIG. 11



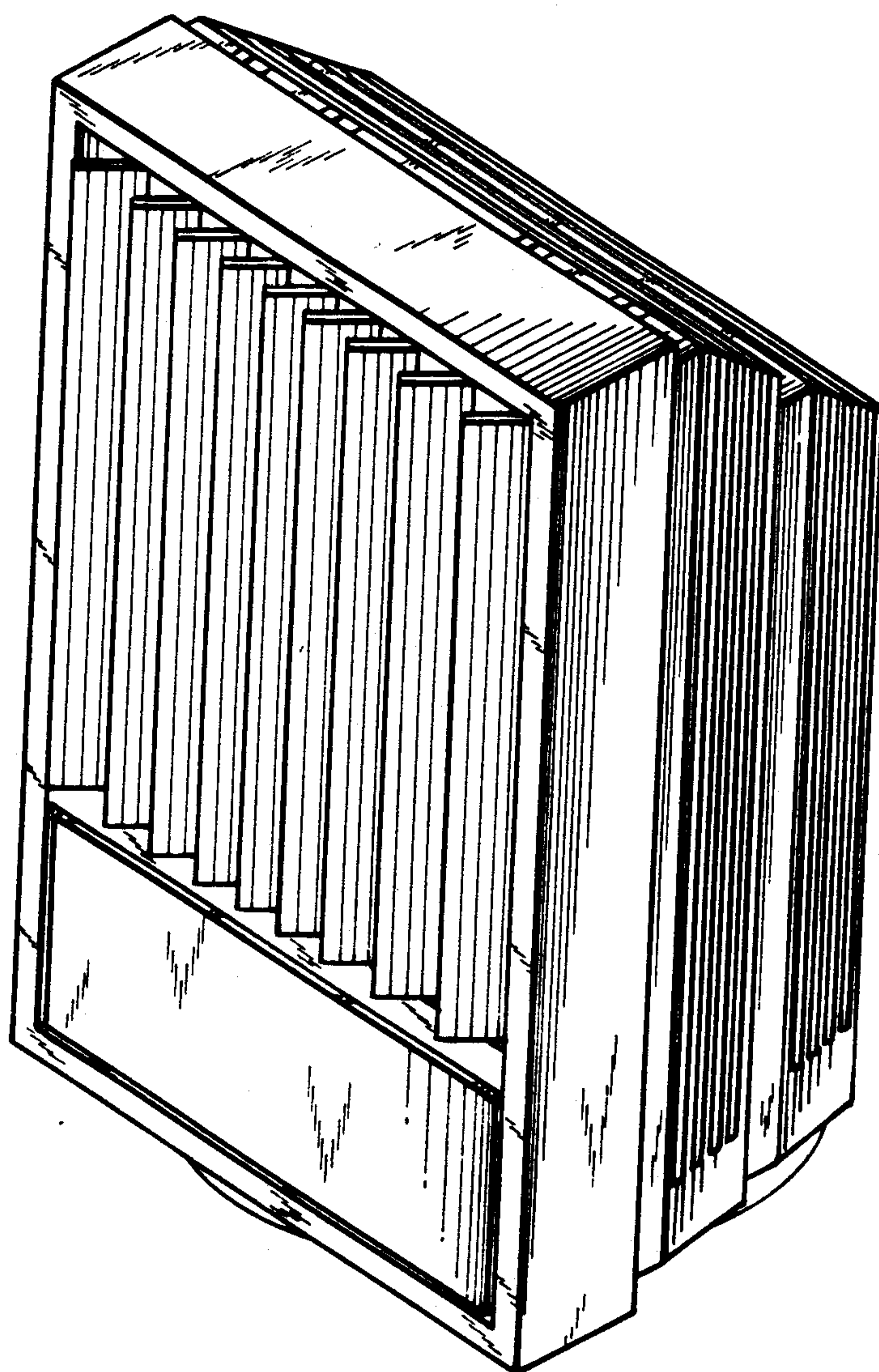

FIG.12