

[54] BOOK END

[75] Inventors: **Kent W. Murphy**, Wooster; **Charles W. Craft, Jr.**, Apple Creek; **Bob Mervar**, Columbus, all of Ohio

[73] Assignee: **Rubbermaid Incorporated**, Wooster, Ohio

[\*\*] Term: **14 Years**

[21] Appl. No.: **251,867**

[22] Filed: **Oct. 3, 1988**

[52] U.S. Cl. .... **D19/34.1**

[58] Field of Search ..... **D19/34.1; D25/119, 129, D25/123, 125; D8/354, 366, 381; 248/300; 81/45, 51; 211/42, 43**

[56] **References Cited**

**U.S. PATENT DOCUMENTS**

D. 247,078 1/1978 Grusin ..... D19/34.1  
643,773 2/1900 Metcalf ..... 248/300 X

**OTHER PUBLICATIONS**

Catalog Page, W. T. Rogers Co., 1401 W. Badger Road, P.O. Box 4327, Madison, Wis. 53711.

Catalog Page, Eldon Office Products, 1130 East 230th St., Carson, Calif. 90745.

Page 17, Placewares Mail Order Dept., 351 Congress St., Boston, Mass. 02210.

Sell Sheet, Plast-Teknife, Box 4123, S-422.04, Hisings Backa, Sweden.

*Primary Examiner*—Wallace R. Burke

*Assistant Examiner*—Pamela J. Schmidt

*Attorney, Agent, or Firm*—Richard B. O'Planick

[57] **CLAIM**

The ornamental design for a bookend, as shown and described.

**DESCRIPTION**

FIG. 1 is a rear perspective view, showing the back and left side, of a bookend embodying our new design.

FIG. 2 is a top plan view thereof.

FIG. 3 is a bottom plan view thereof.

FIG. 4 is a front elevational view thereof; the right side view being a mirror image.

FIG. 5 is a left side elevational view thereof, shown partially in perspective;

FIG. 6 is a cross-sectional view thereof, taken along line 6—6 of FIG. 5;

FIG. 7 is a rear end elevational view thereof; and

FIG. 8 is a front end elevational view thereof.

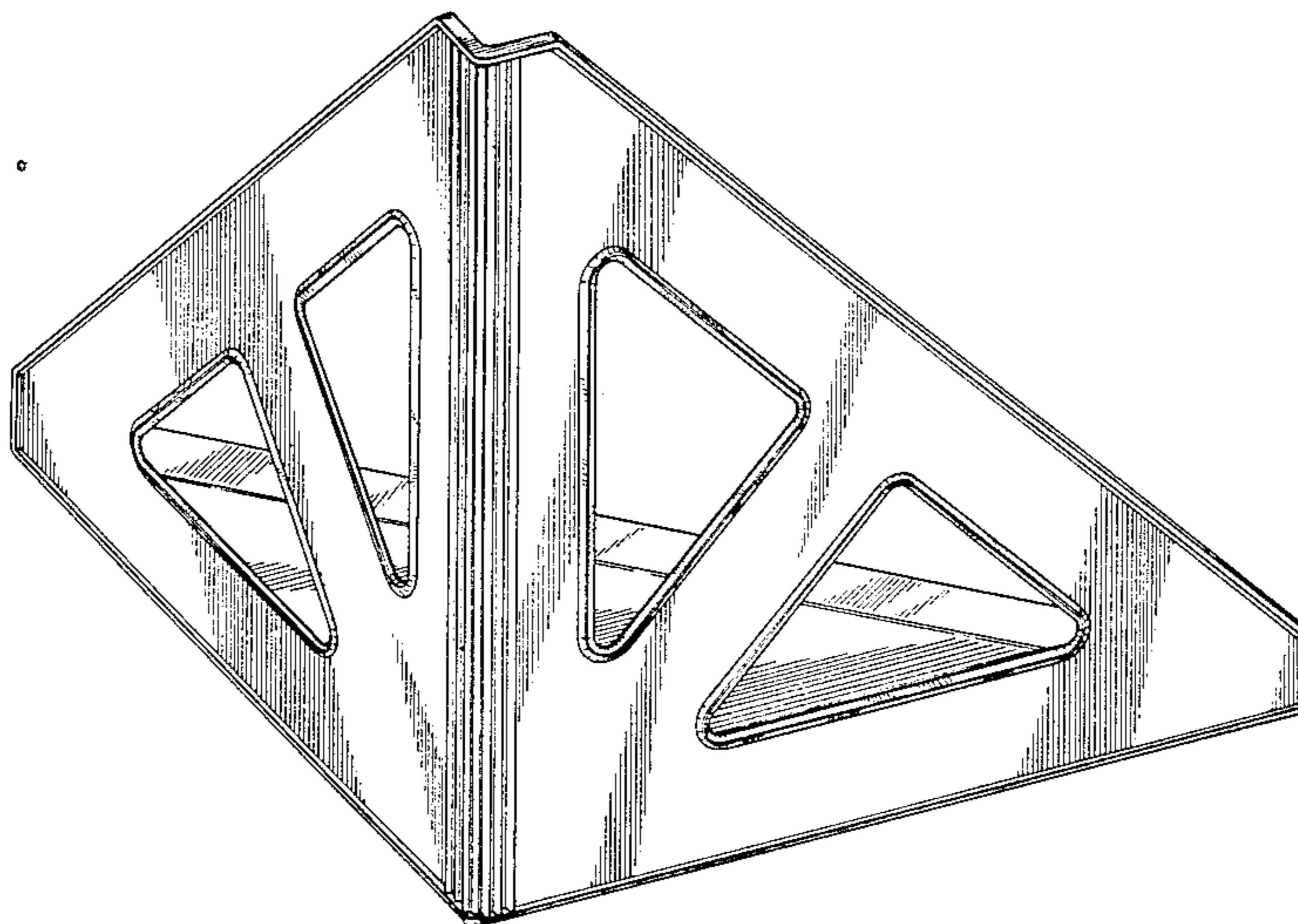

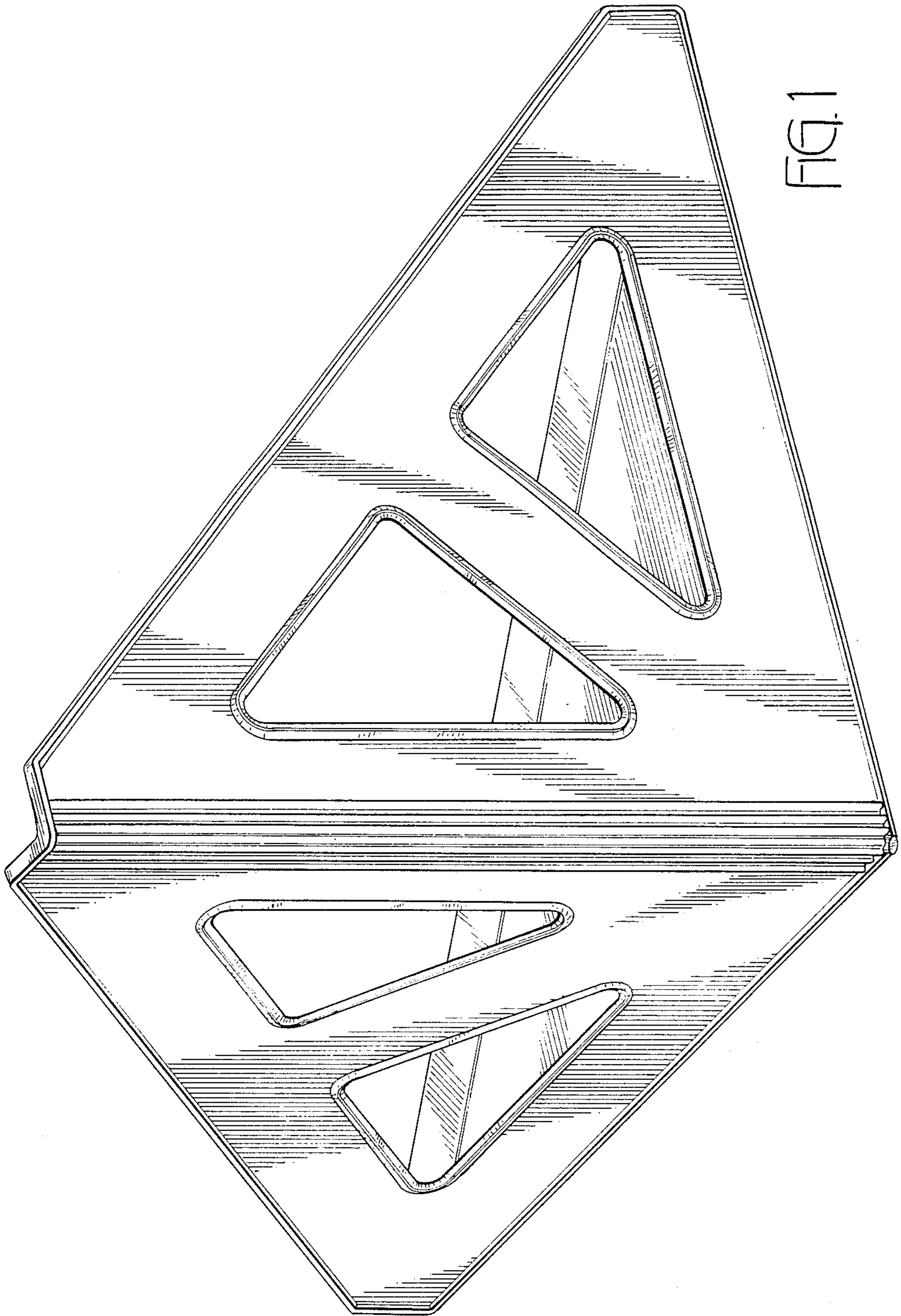

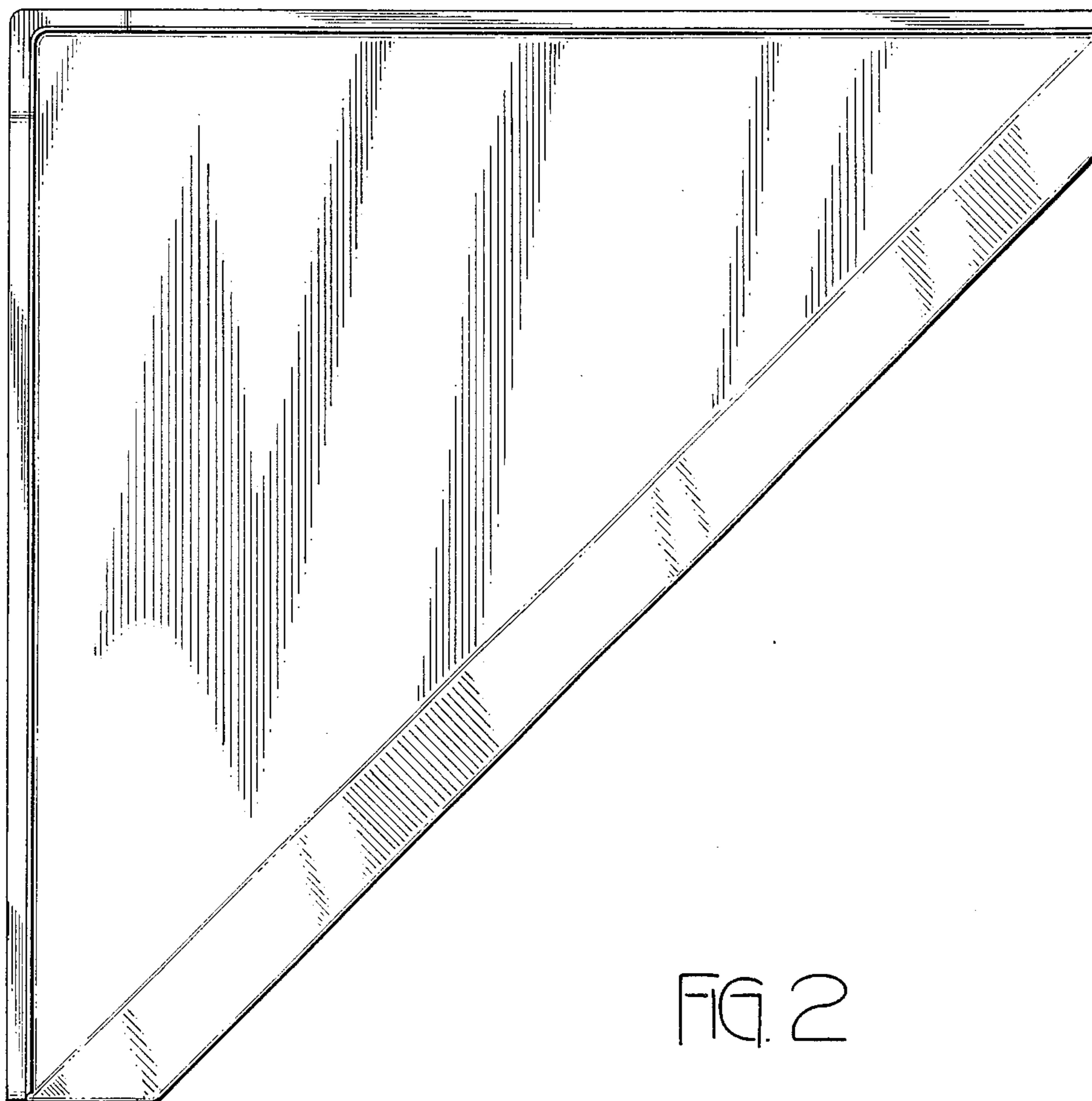

FIG. 2

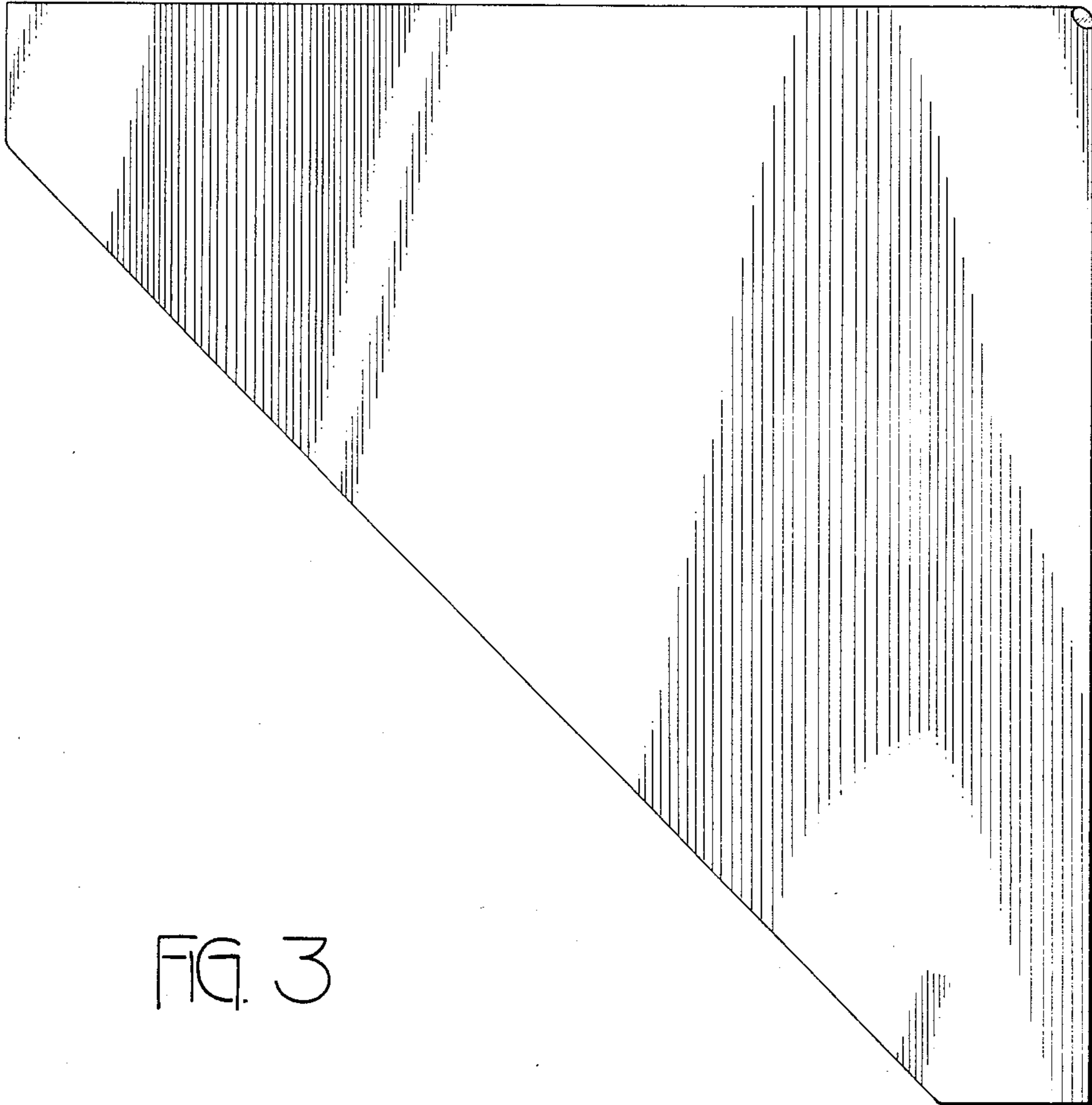

FIG. 3

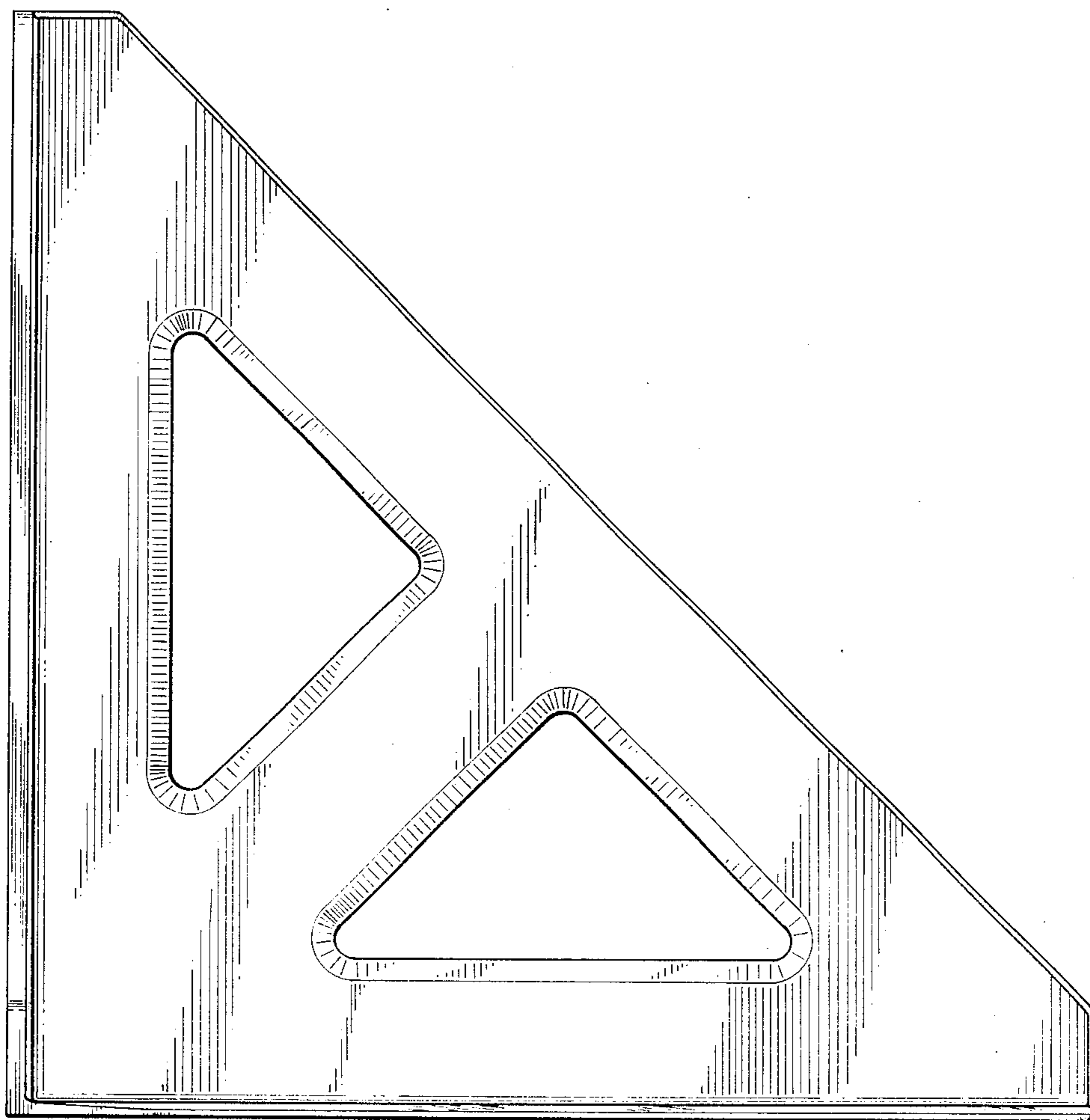

FIG. 4

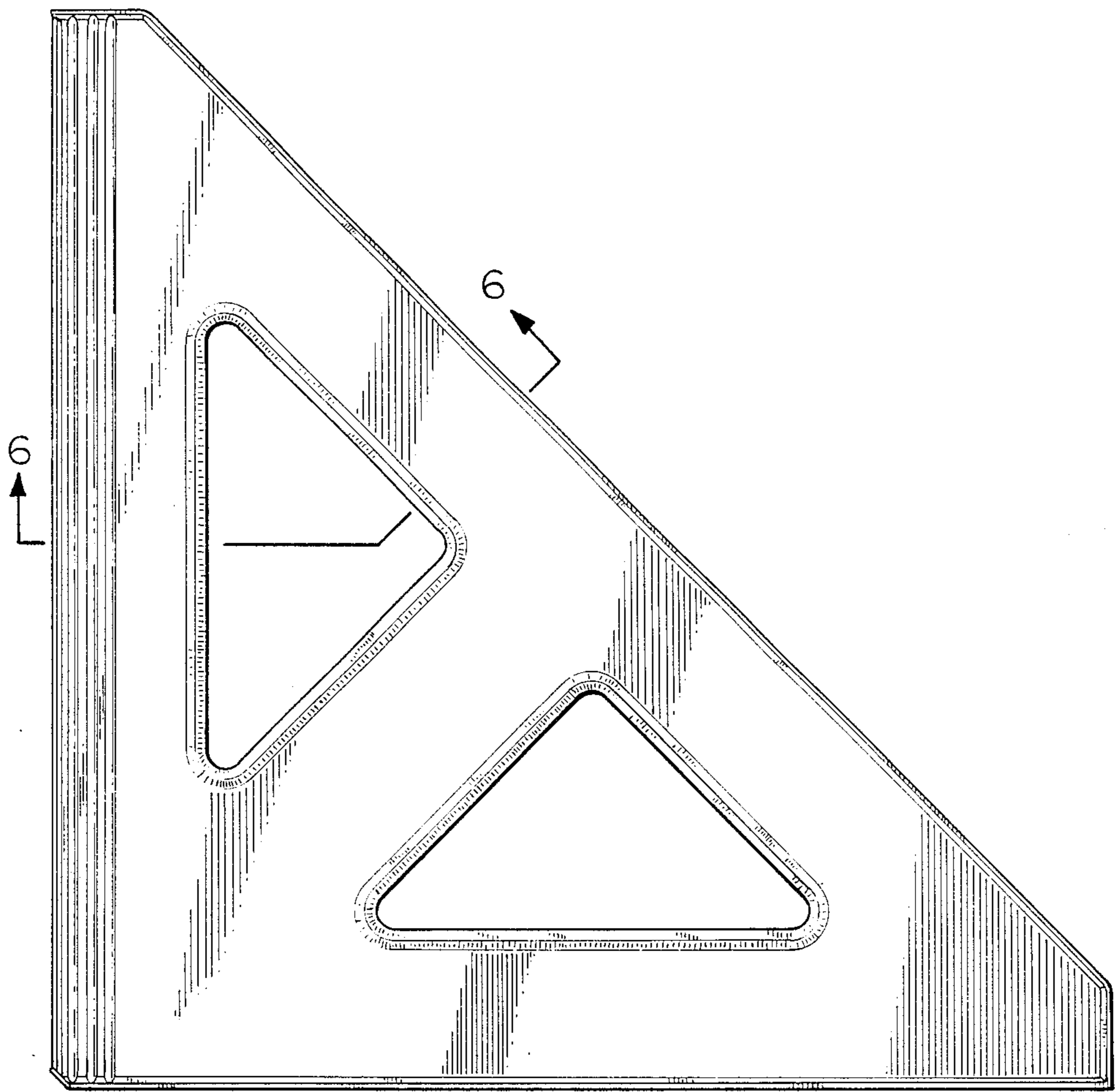

FIG. 5

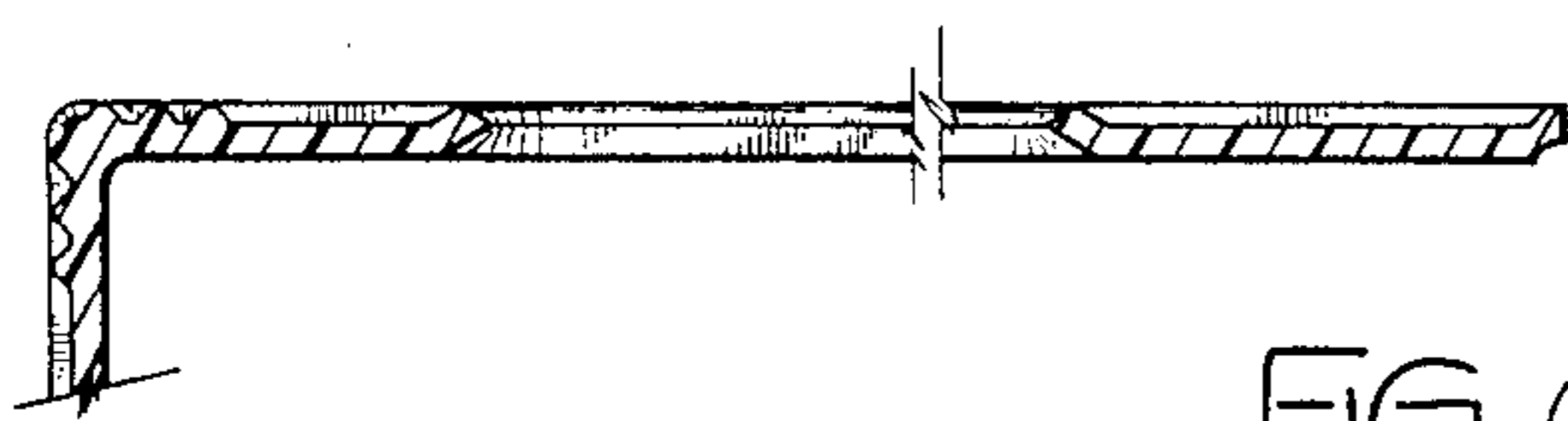

FIG. 6

FIG. 7

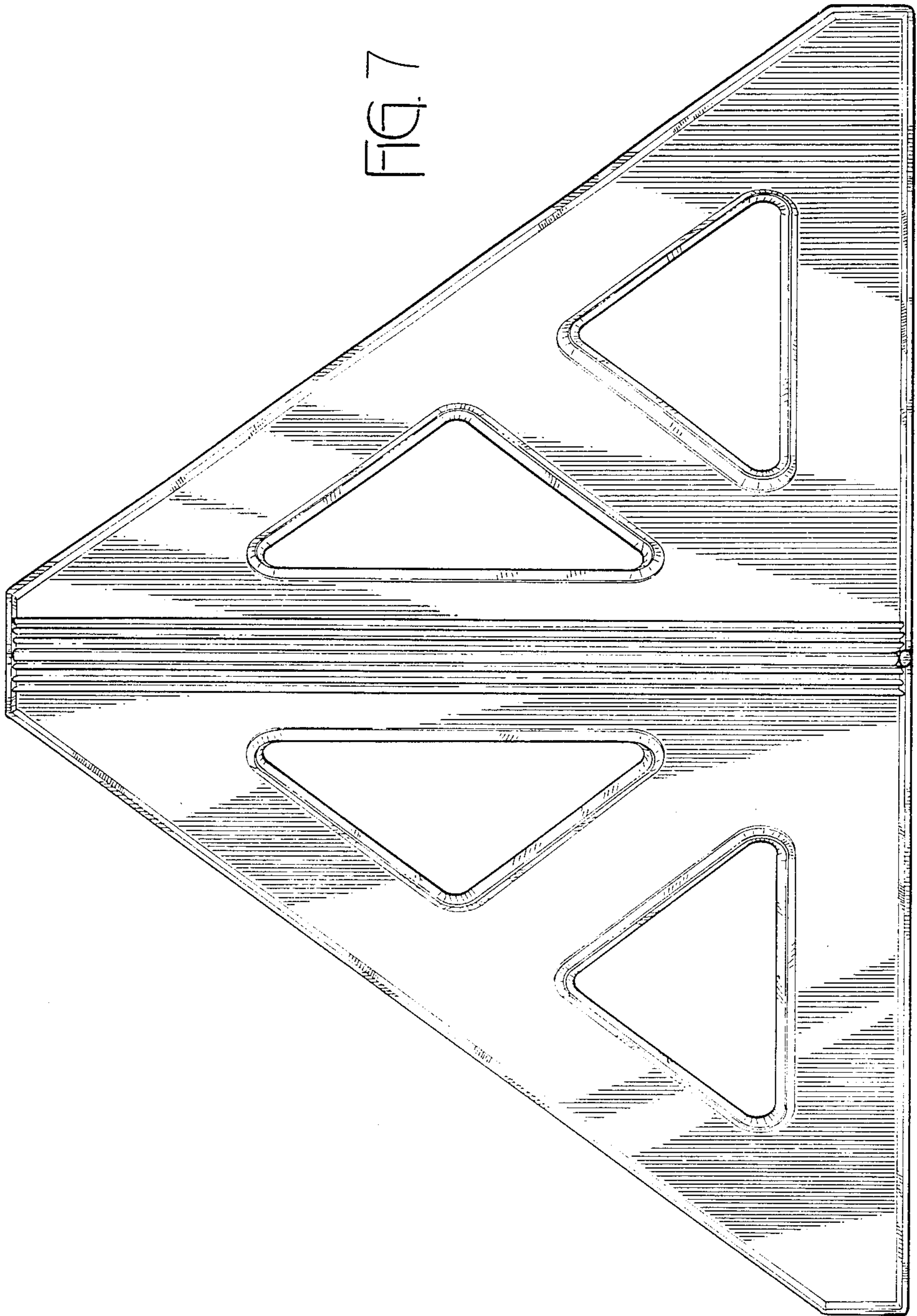

FIG. 8

