

[54] PUTTER HEAD

3,408,074 10/1968 Antonious .
4,693,478 9/1987 Long .

[75] Inventors: Donald A. Anderson, Huntington Beach, Calif.; Donald J. C. Sun, No. 6 Lane, 262 Chien Fong Road, Kang Shan Kaohsiung, Taiwan, 820

OTHER PUBLICATIONS

Golf World, Aug. 1, 1986, p. 13, middle right, Pinnacle Putter.

[73] Assignee: Donald J. C. Sun, Kan San Kaohsiung, Taiwan; a part interest

Primary Examiner—Melvin B. Feifer
Attorney, Agent, or Firm—William W. Haefliger

[**] Term: 14 Years

[57] CLAIM

[21] Appl. No.: 182,067

The ornamental design for a putter head, as shown and described.

[22] Filed: Apr. 14, 1988

[52] U.S. Cl. D21/219

DESCRIPTION

[58] Field of Search D21/214-220;
273/167-175, 163 R, 164

FIG. 1 is a front elevational view of the putter head showing my new design;

[56] References Cited

U.S. PATENT DOCUMENTS

- D. 256,262 8/1980 Benson .
- D. 275,981 10/1984 Duclos D21/219
- 2,517,245 8/1950 Scott .
- 3,333,854 8/1967 White .

FIG. 2 is a rear elevational view of the FIG. 1 putter head;

FIG. 3 is a bottom plan view of the FIG. 1 putter head;

FIG. 4 is a top plan view of the FIG. 1 putter head;

FIG. 5 is a left end view of the FIG. 1 putter head;

FIG. 6 is a right end view of the FIG. 1 putter head; and

FIG. 7 is a section on lines 7-7 of FIG. 2.

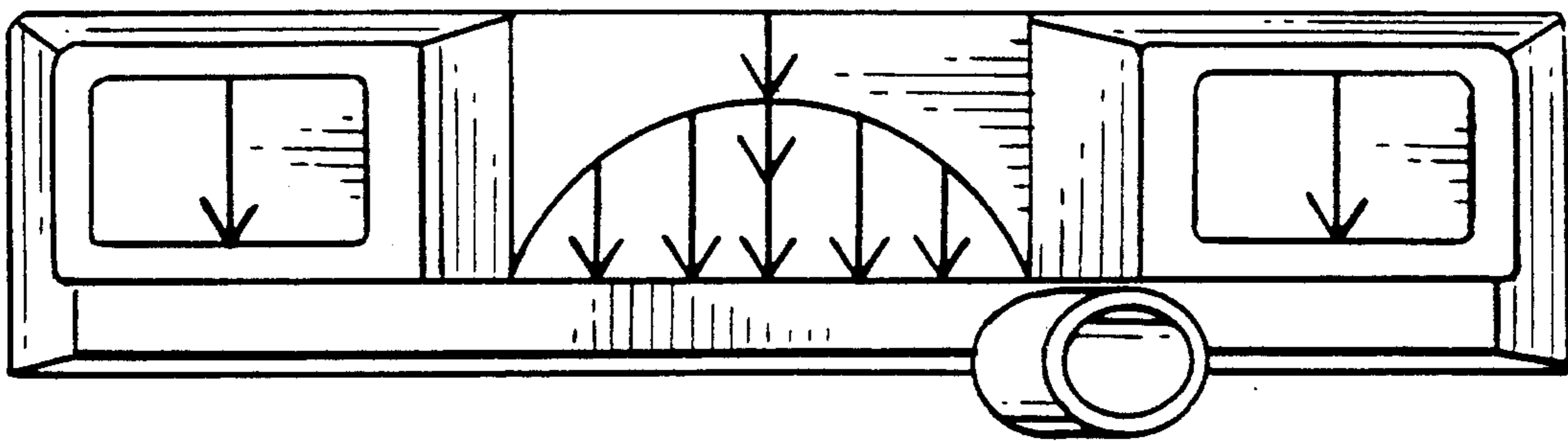

FIG. 1.

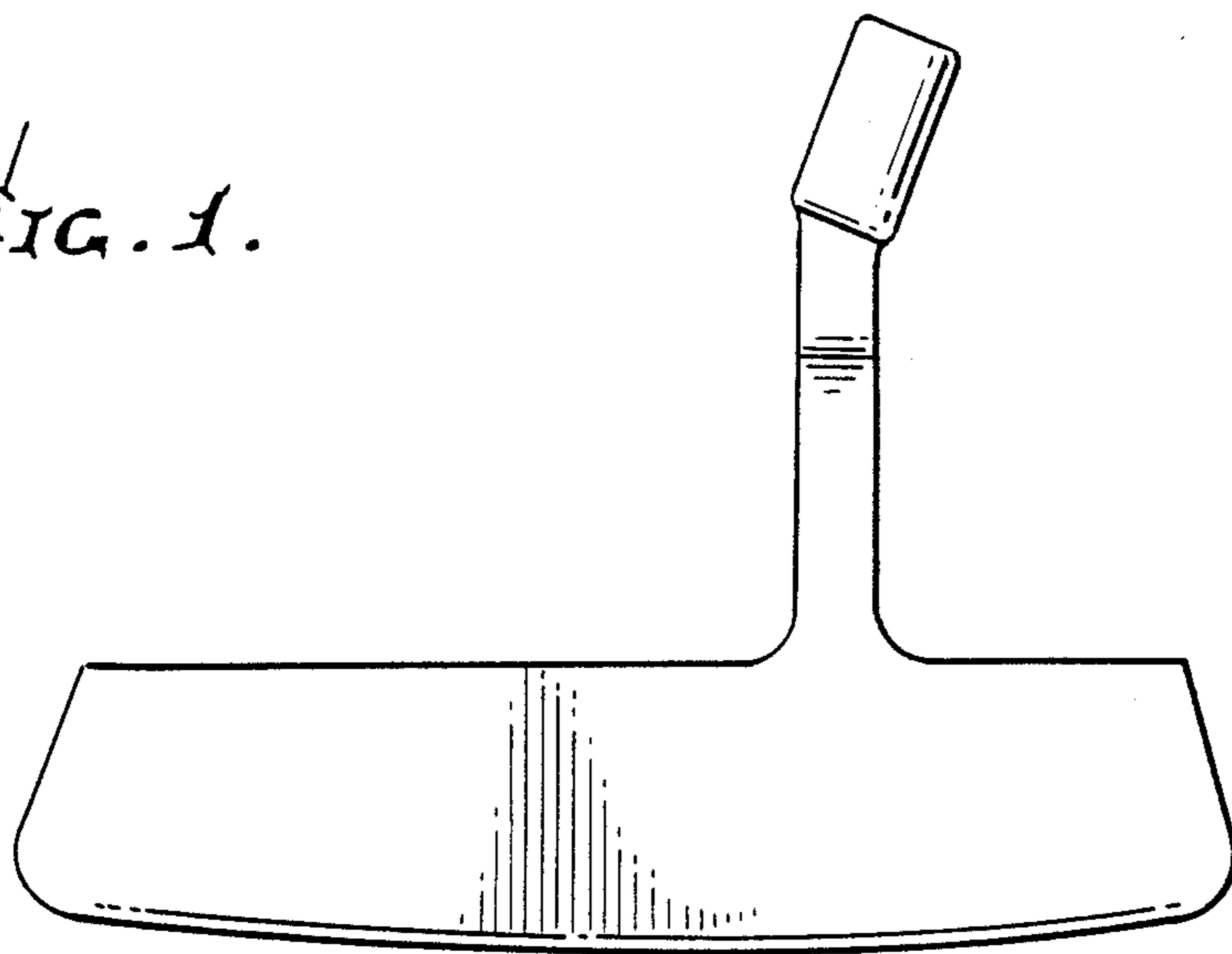

FIG. 2.

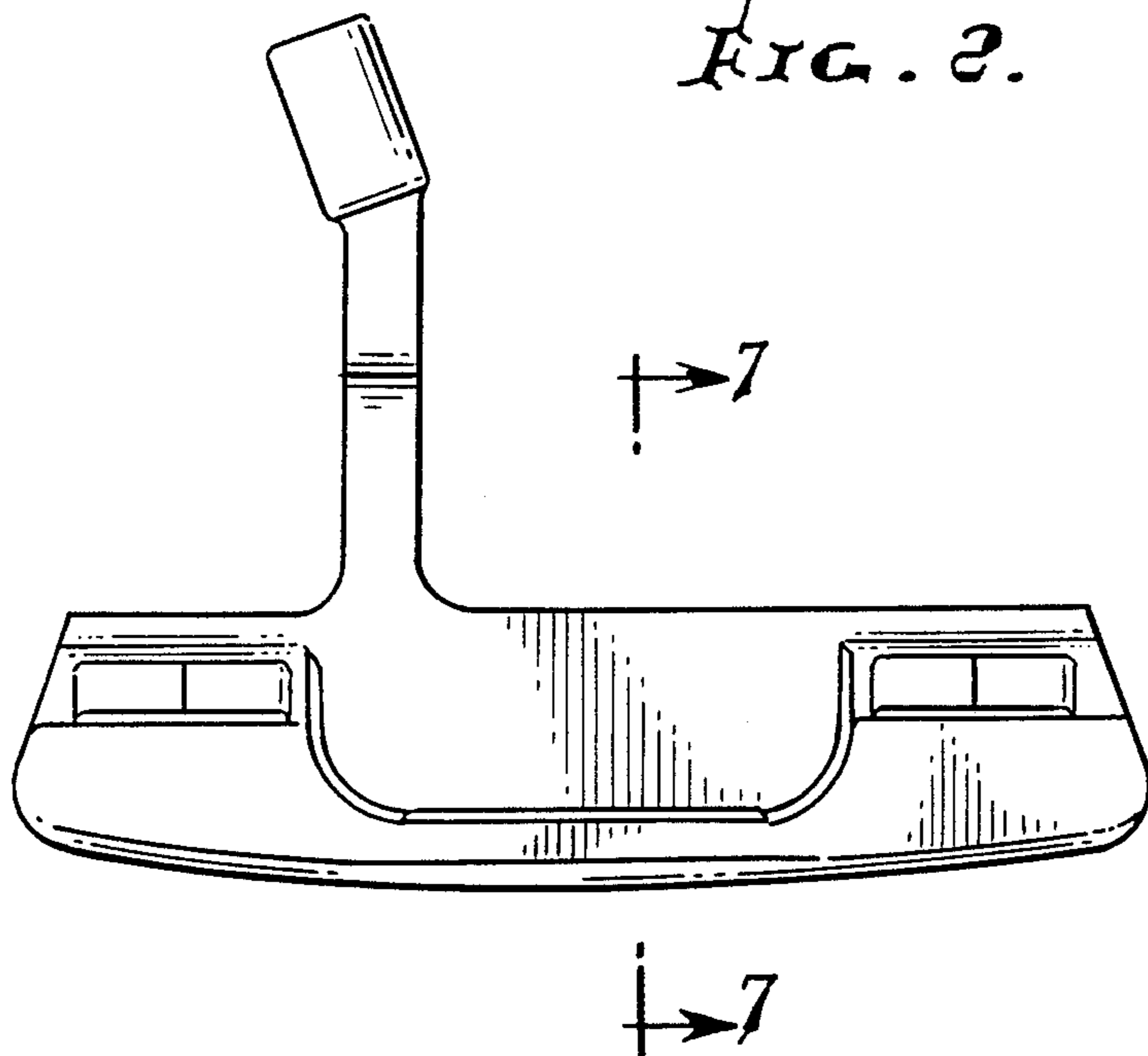

FIG. 3.

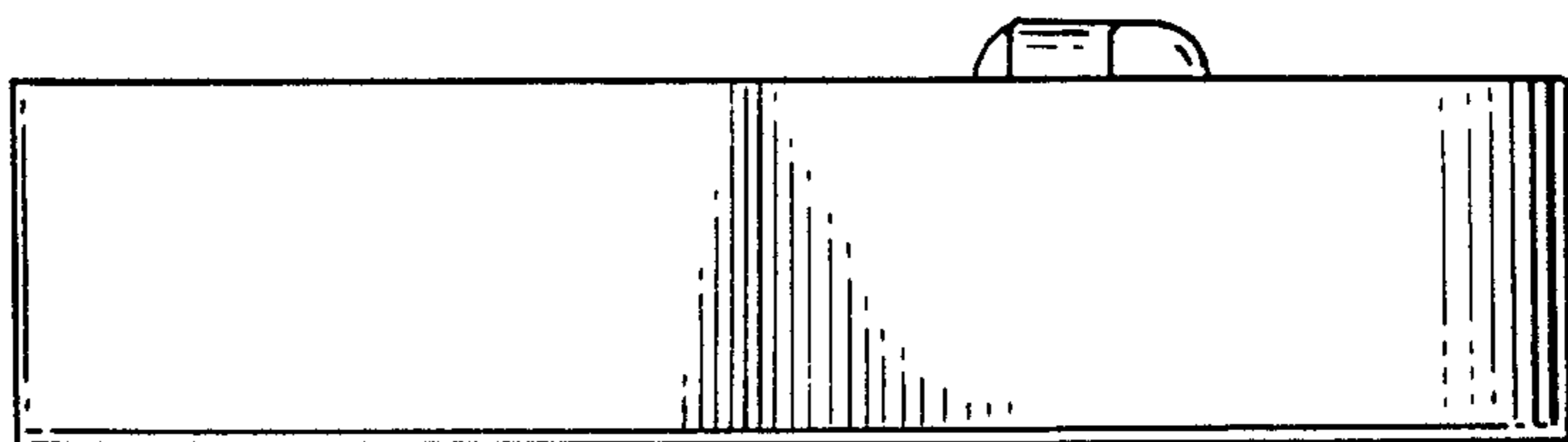

FIG. 4.

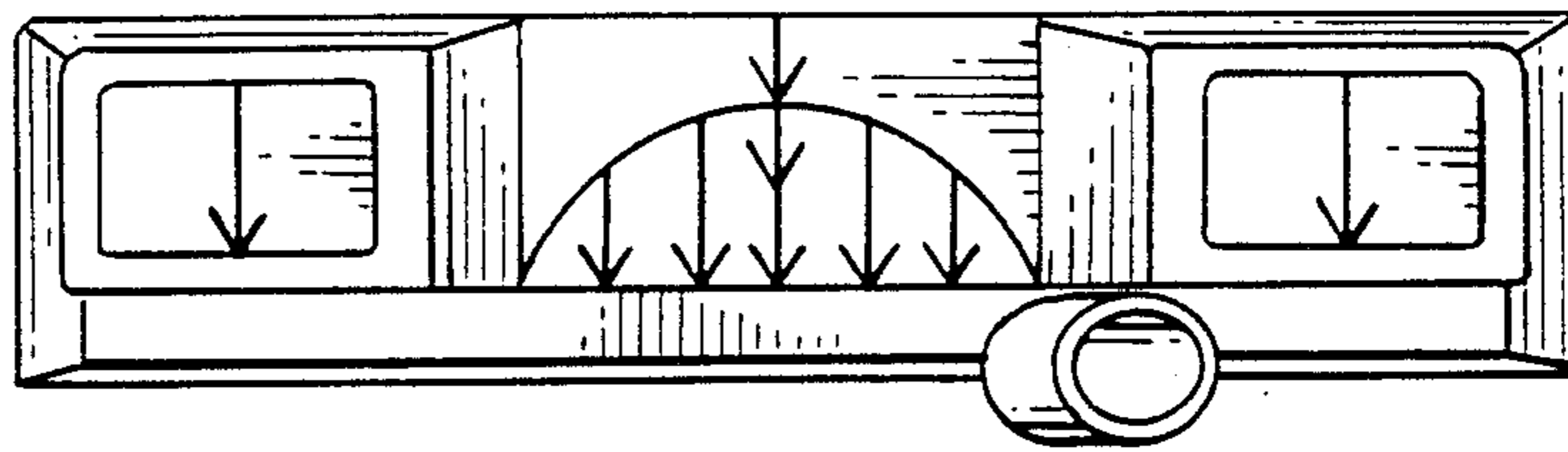

FIG. 5.

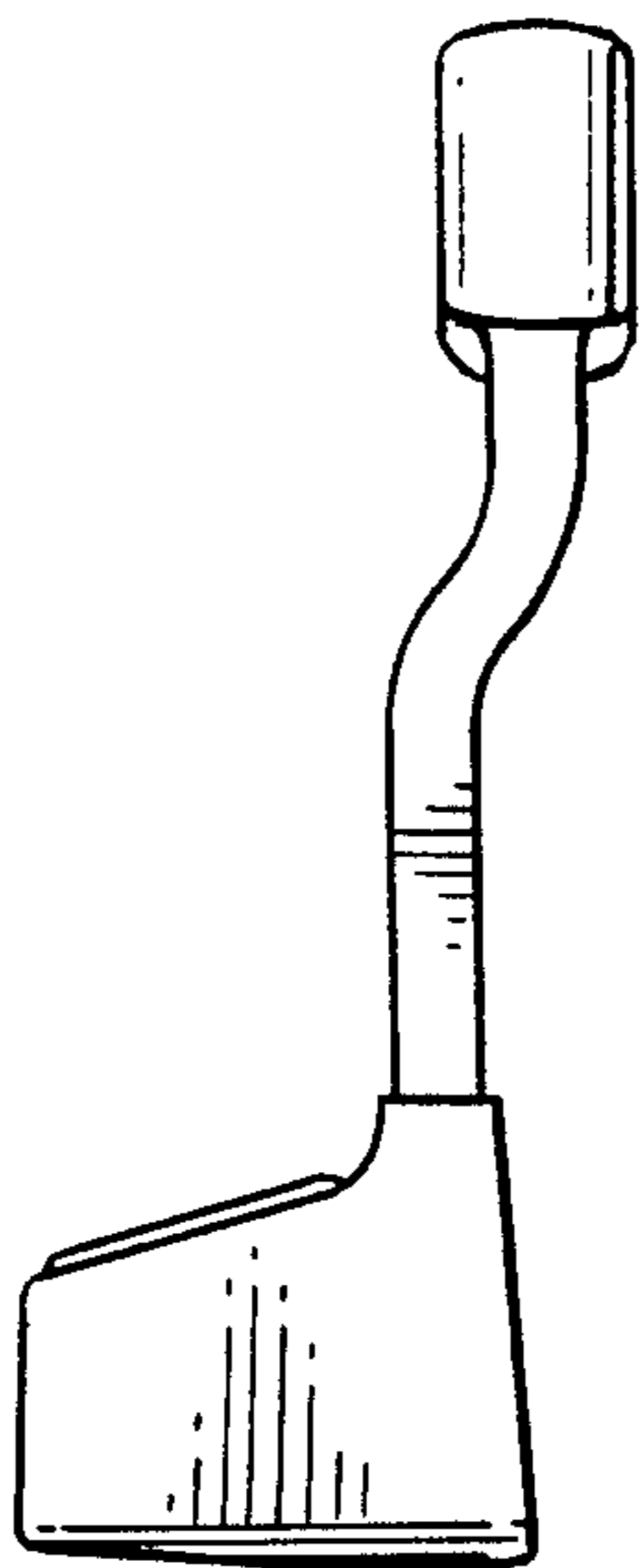

FIG. 6.

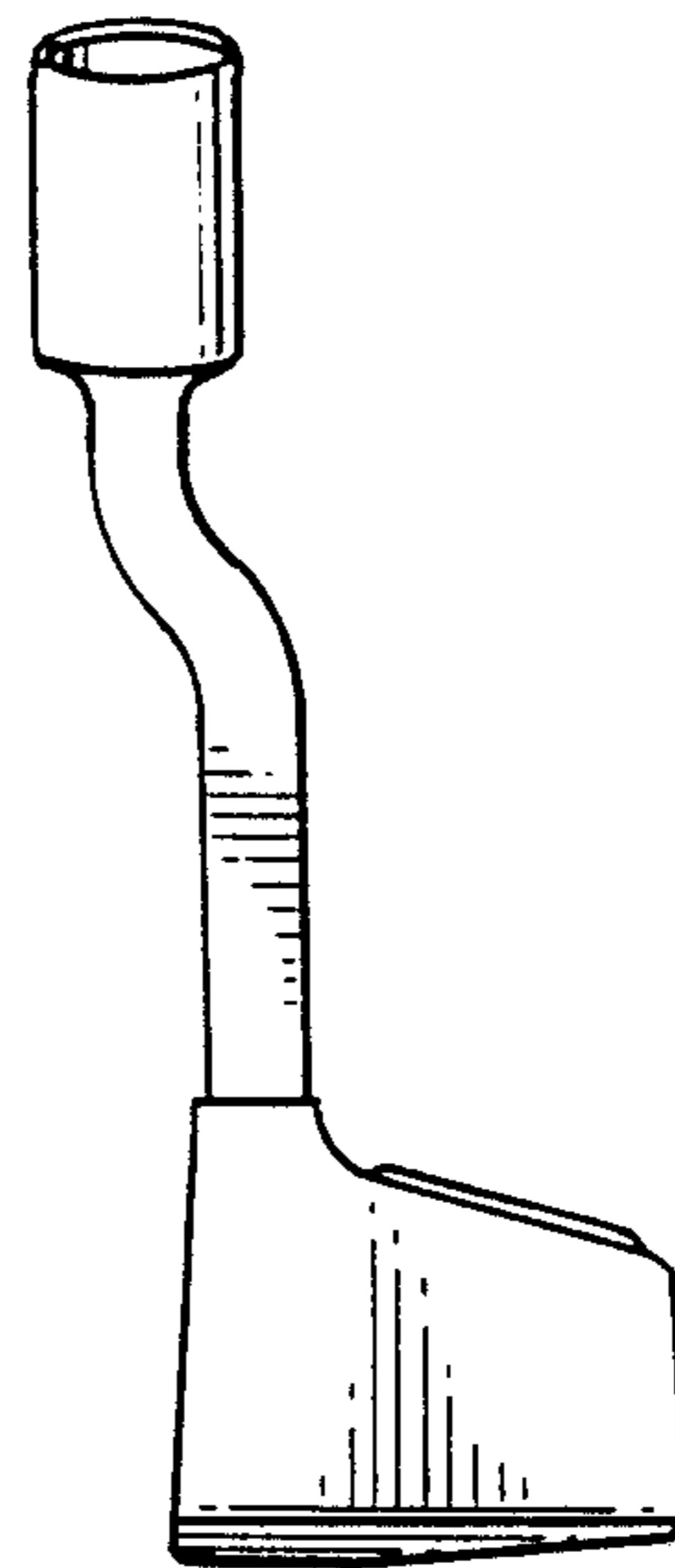

FIG. 7.

