

[54] MOTOR DRIVEN TOY FLOWER

[75] Inventor: Isamu Kataoka, Ichikawa, Japan

[73] Assignee: Takara Co., Ltd., Tokyo, Japan

[\*\*] Term: 14 Years

[21] Appl. No.: 320,749

[22] Filed: Mar. 8, 1989

[30] Foreign Application Priority Data

Jan. 13, 1989 [JP] Japan ..... 1-1020

[52] U.S. Cl. .... D21/150

[58] Field of Search ..... D21/59, 109, 150, 168, D21/155, 148; 446/175, 303, 390; 272/8 N, 27 N; 428/12, 24; 40/411, 414; D11/117, 152, 143; D10/9; D23/367

[56] References Cited

U.S. PATENT DOCUMENTS

D. 147,852 11/1947 Hyman ..... D21/65

D. 193,155	7/1962	Goldman et al. ....	D11/117
D. 223,313	4/1972	White .....	D11/117
D. 230,482	2/1974	Levey .....	D23/367
D. 295,653	5/1988	Colclasure .....	D21/155
3,673,909	7/1972	Birnkrant .....	446/418
4,903,424	2/1990	Satoh et al. ....	428/24

Primary Examiner—Charles A. Rademaker  
Attorney, Agent, or Firm—Price, Gess & Ubell

[57] CLAIM

The ornamental design for a motor driven toy flower, as shown and described.

DESCRIPTION

FIG. 1 is a front perspective view of a motor driven toy flower showing my new design;  
FIG. 2 is a front elevational view thereof;  
FIG. 3 is a right side elevational view thereof;  
FIG. 4 is a left side elevational view thereof;  
FIG. 5 is a rear elevational view thereof;  
FIG. 6 is a top plan view thereof; and  
FIG. 7 is a bottom plan view thereof.

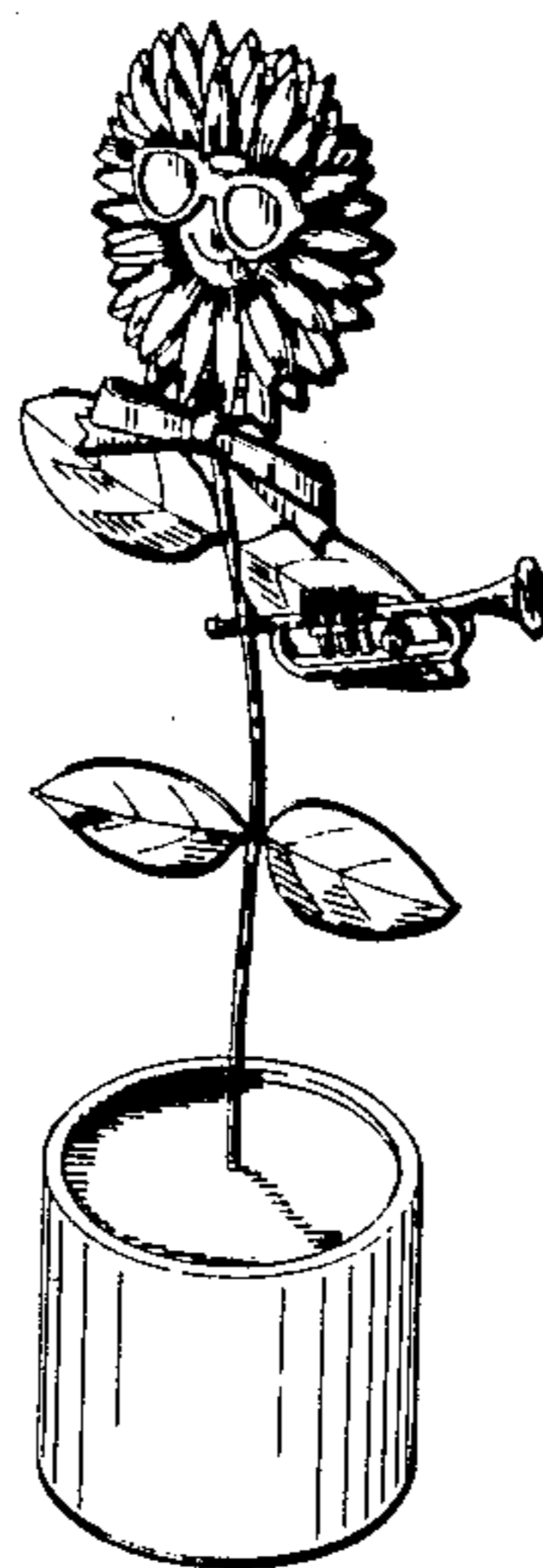

FIG. 1

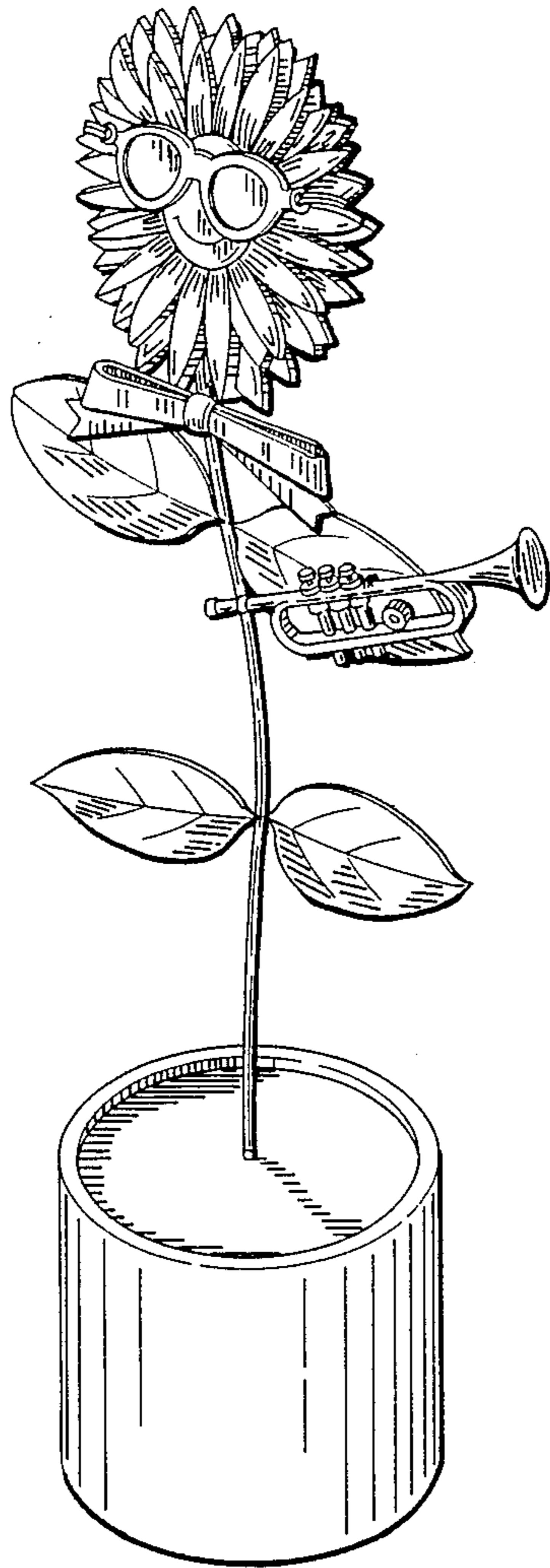

FIG. 2

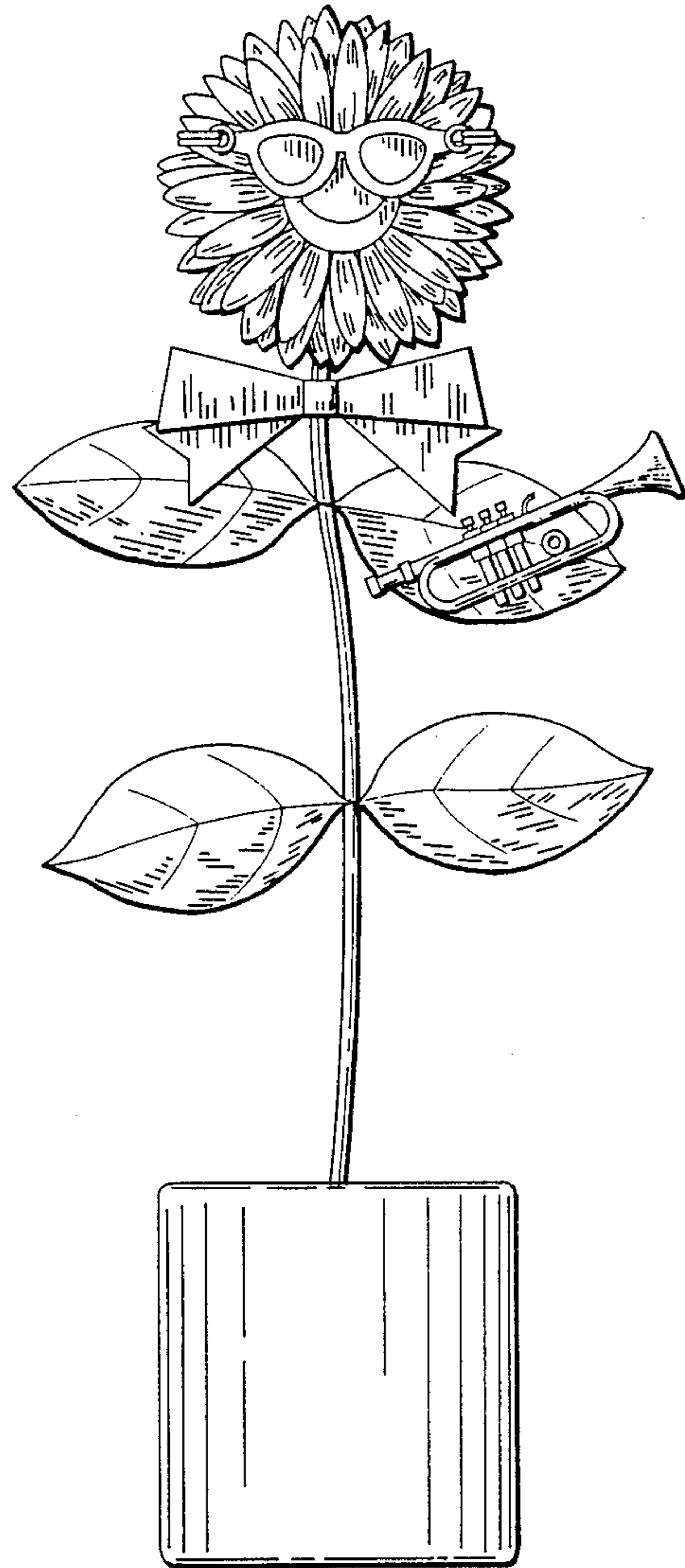

FIG. 3

FIG. 4

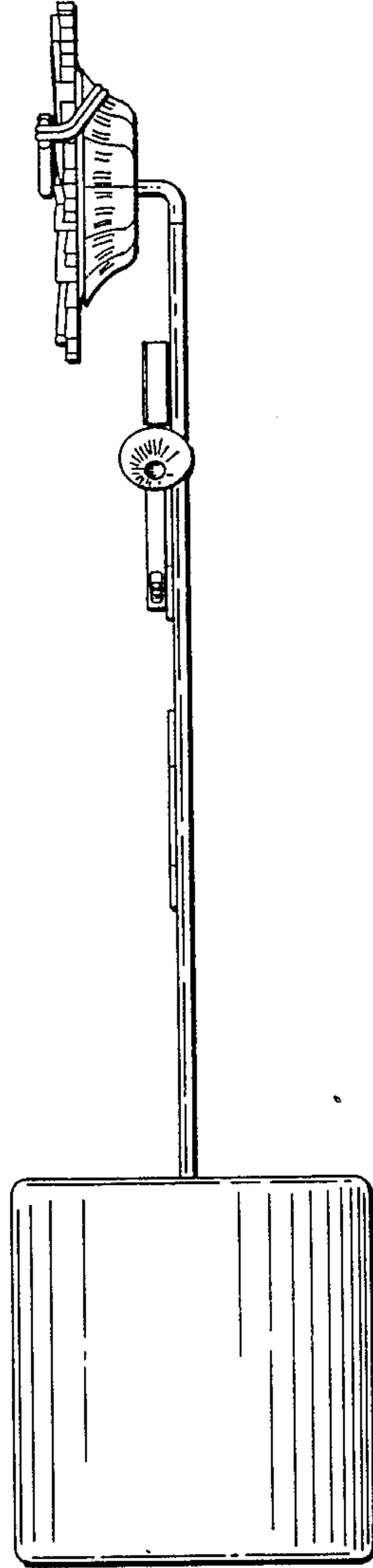
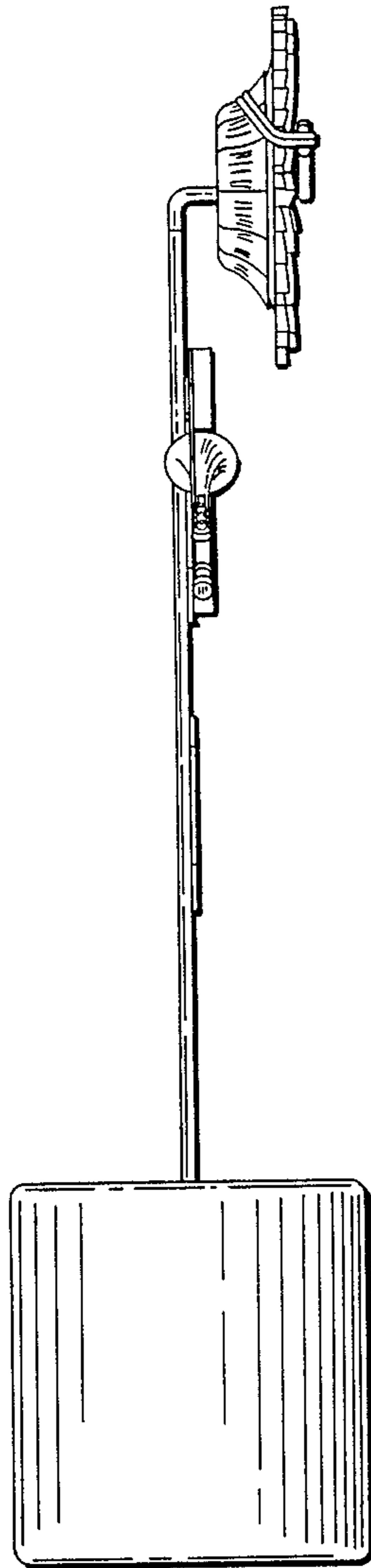

FIG. 5

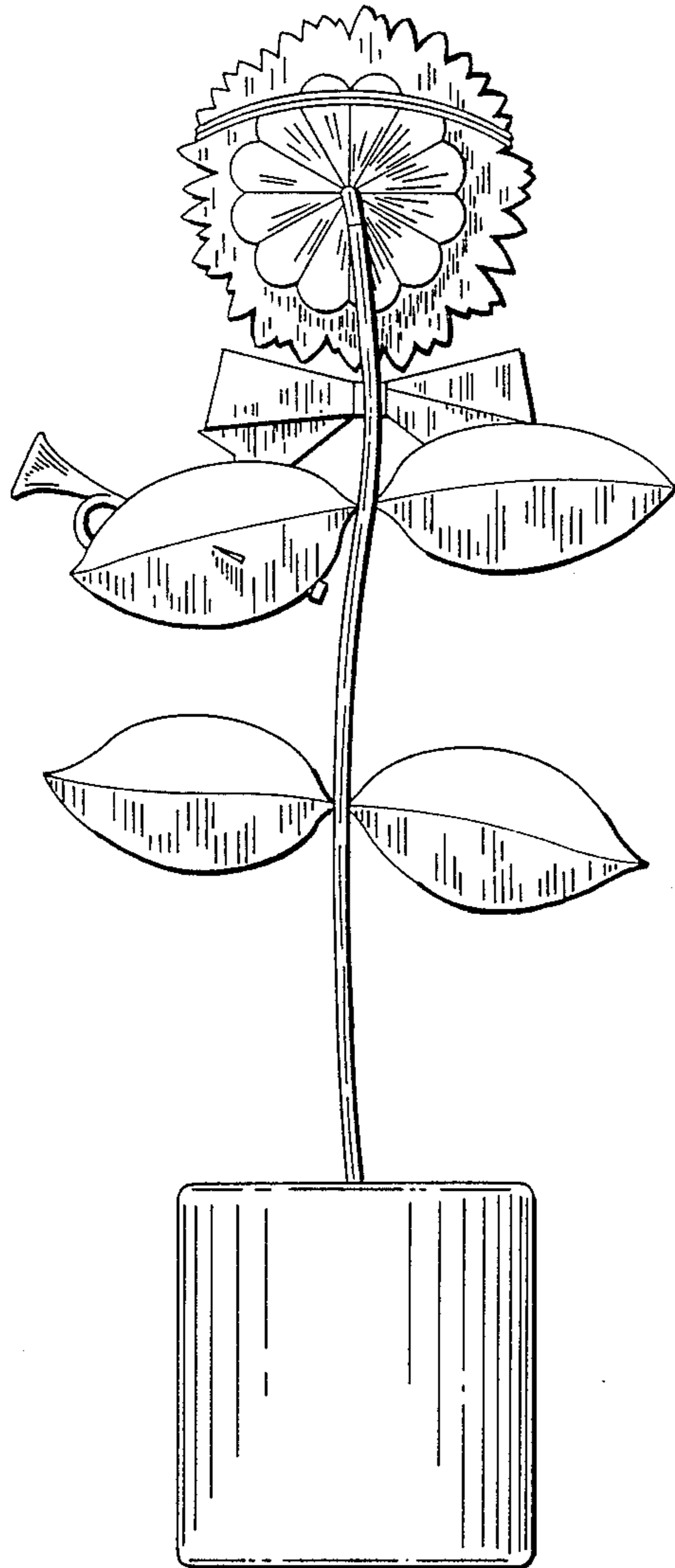

FIG. 6

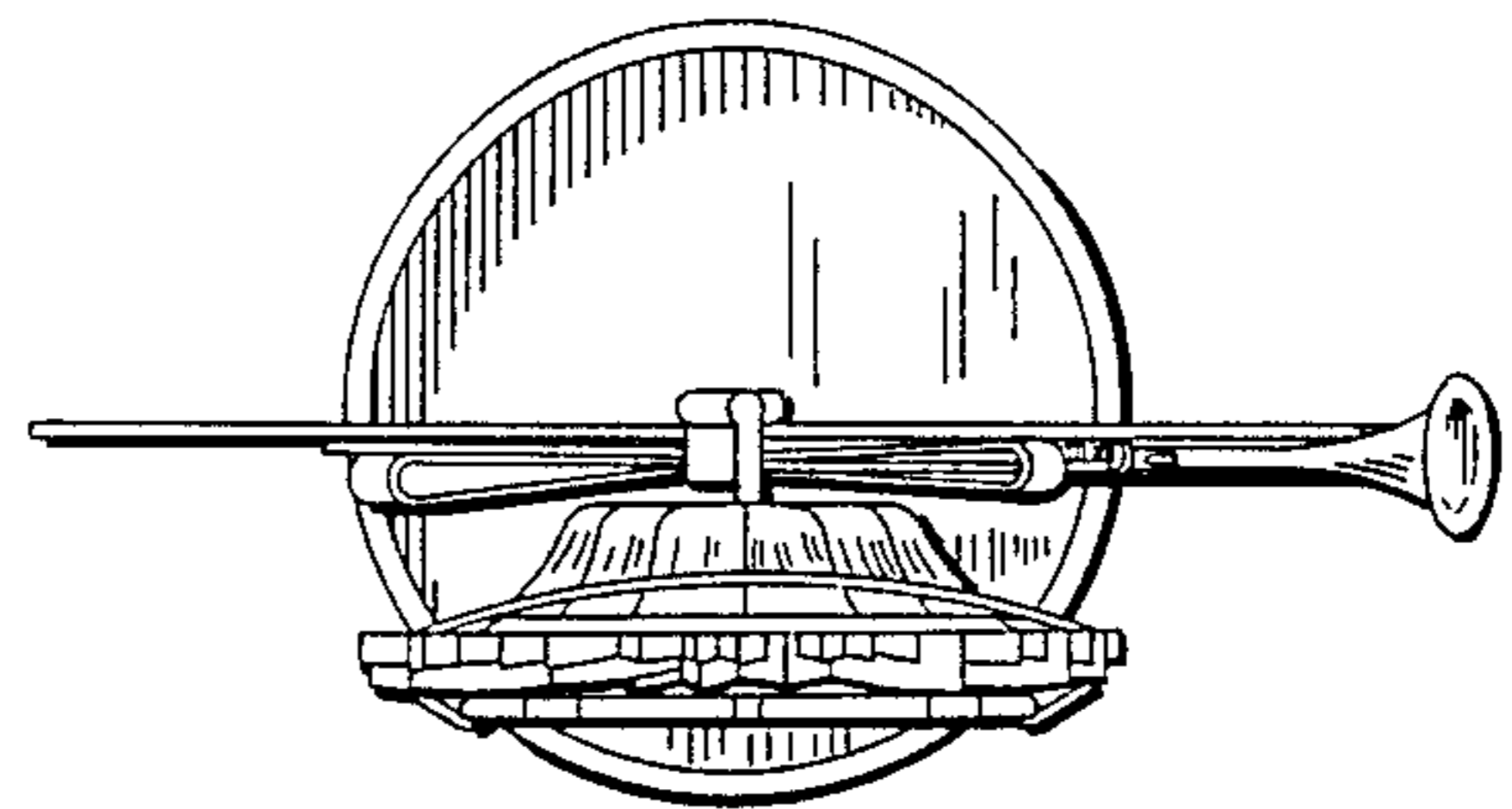

FIG. 7

