

[54] **COMBINATION CAMERA AND MIRROR**

[75] **Inventor:** Nobufusa Kuroki, Tokyo, Japan
[73] **Assignee:** Janome Sewing Machine Co. Ltd.,
Tokyo, Japan
[**] **Term:** 14 Years
[21] **Appl. No.:** 151,474
[22] **Filed:** Feb. 2, 1988
[52] **U.S. Cl.** D16/214
[58] **Field of Search** D16/200, 201, 202, 203,
D16/204, 208, 209, 214; 354/220, 290

[56] **References Cited**

U.S. PATENT DOCUMENTS

D. 181,162	10/1957	Nassour	D16/214
D. 201,590	7/1965	Sigmond	D16/214
D. 290,708	7/1987	Rea	D16/225
4,771,300	9/1988	Bryan	354/220

OTHER PUBLICATIONS

Video Review, Dec. 1985, p. 39.

Primary Examiner—Bernard Ansher
Assistant Examiner—Adir Aronovich
Attorney, Agent, or Firm—Michael J. Striker

[57] **CLAIM**

The ornamental design for a combination camera and mirror, as shown and described.

DESCRIPTION

FIG. 1 is a front elevational view of a combination camera and mirror showing my new design; FIG. 2 is a rear elevational view thereof; FIG. 3 is a left side elevational view thereof; and FIG. 4 is a right side elevational view thereof. FIG. 5 is a top plan view thereof; FIG. 6 is a bottom plan view thereof; and FIG. 7 is a perspective thereof.

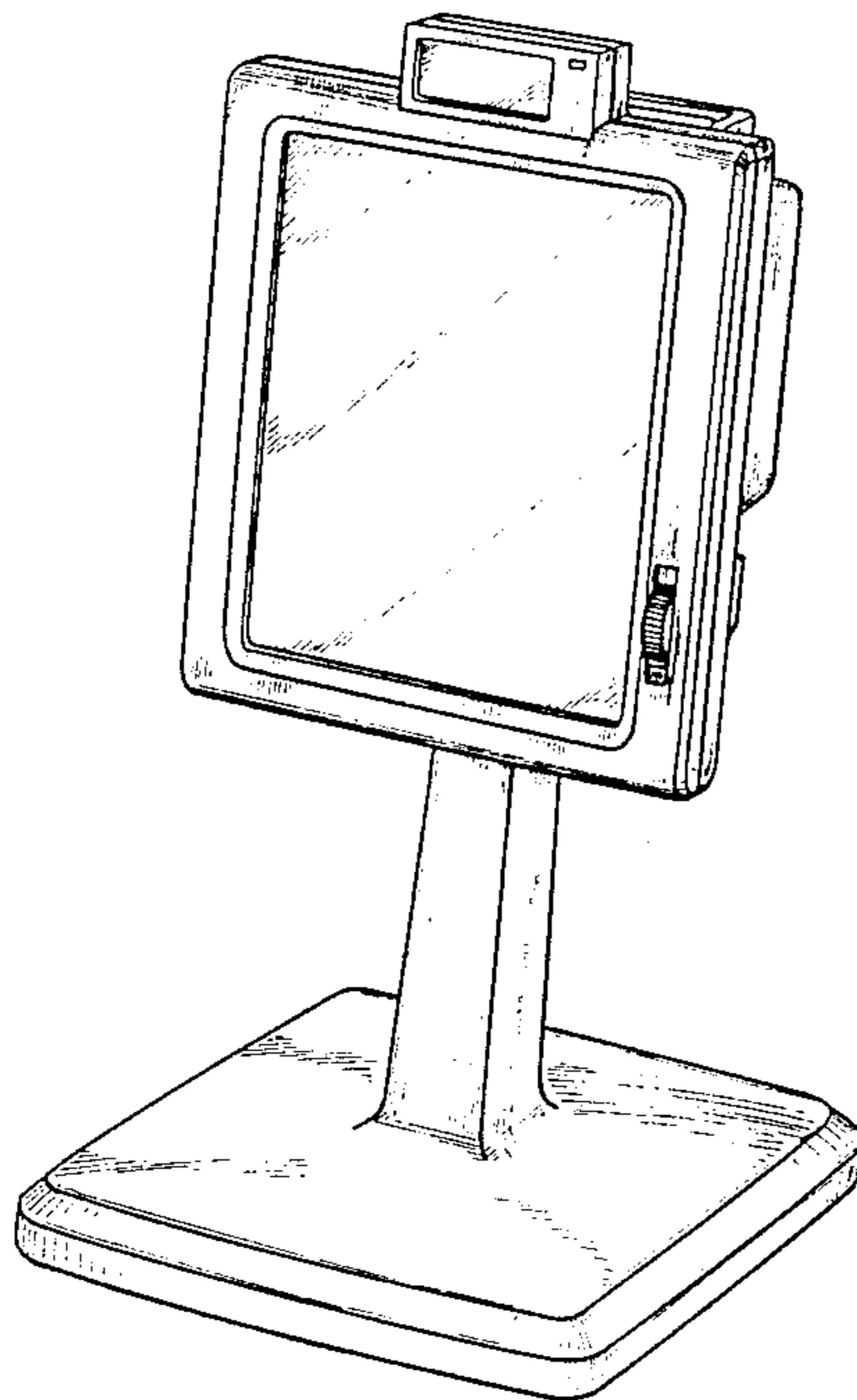

FIG_1

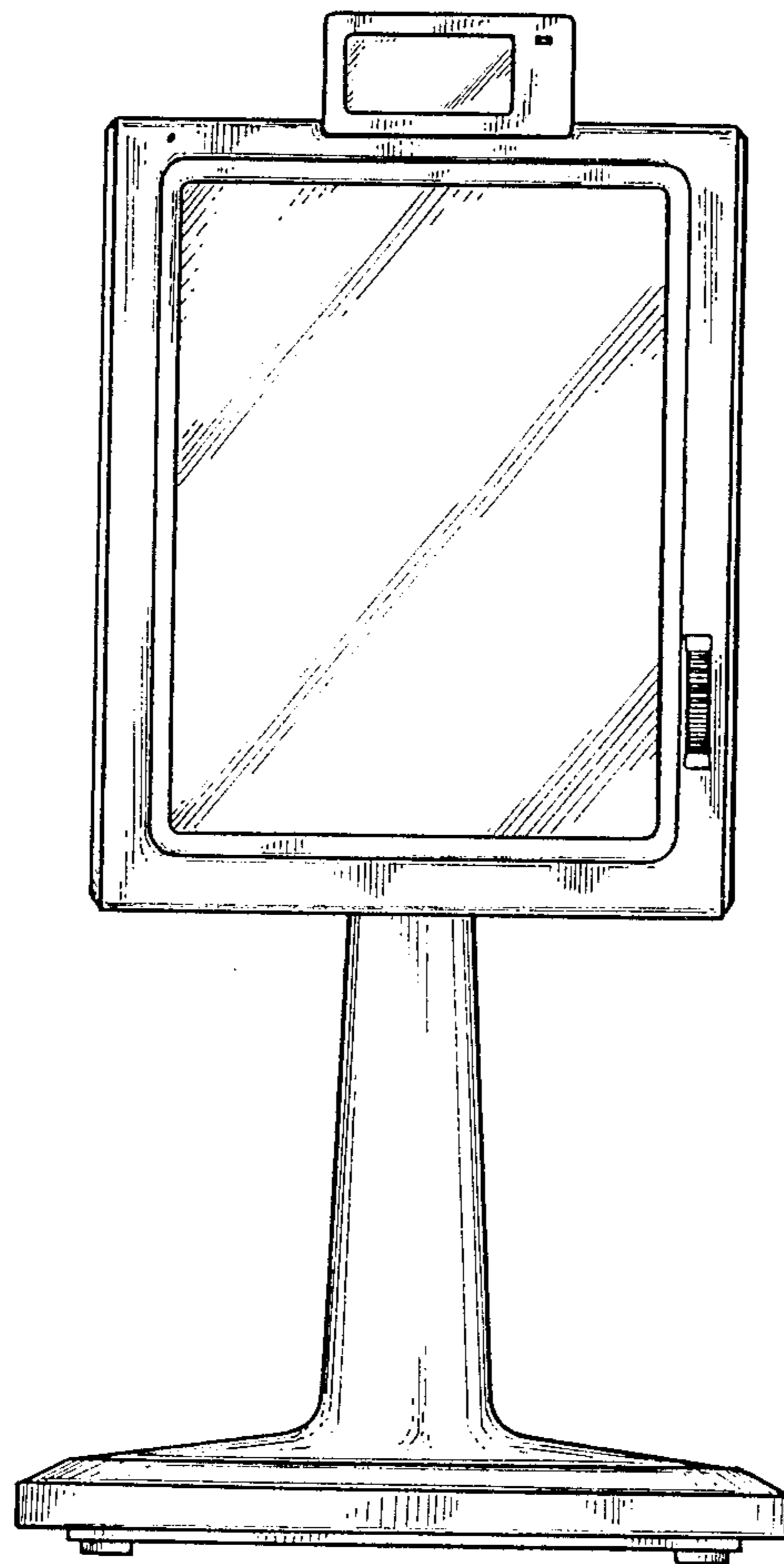

FIG. 2

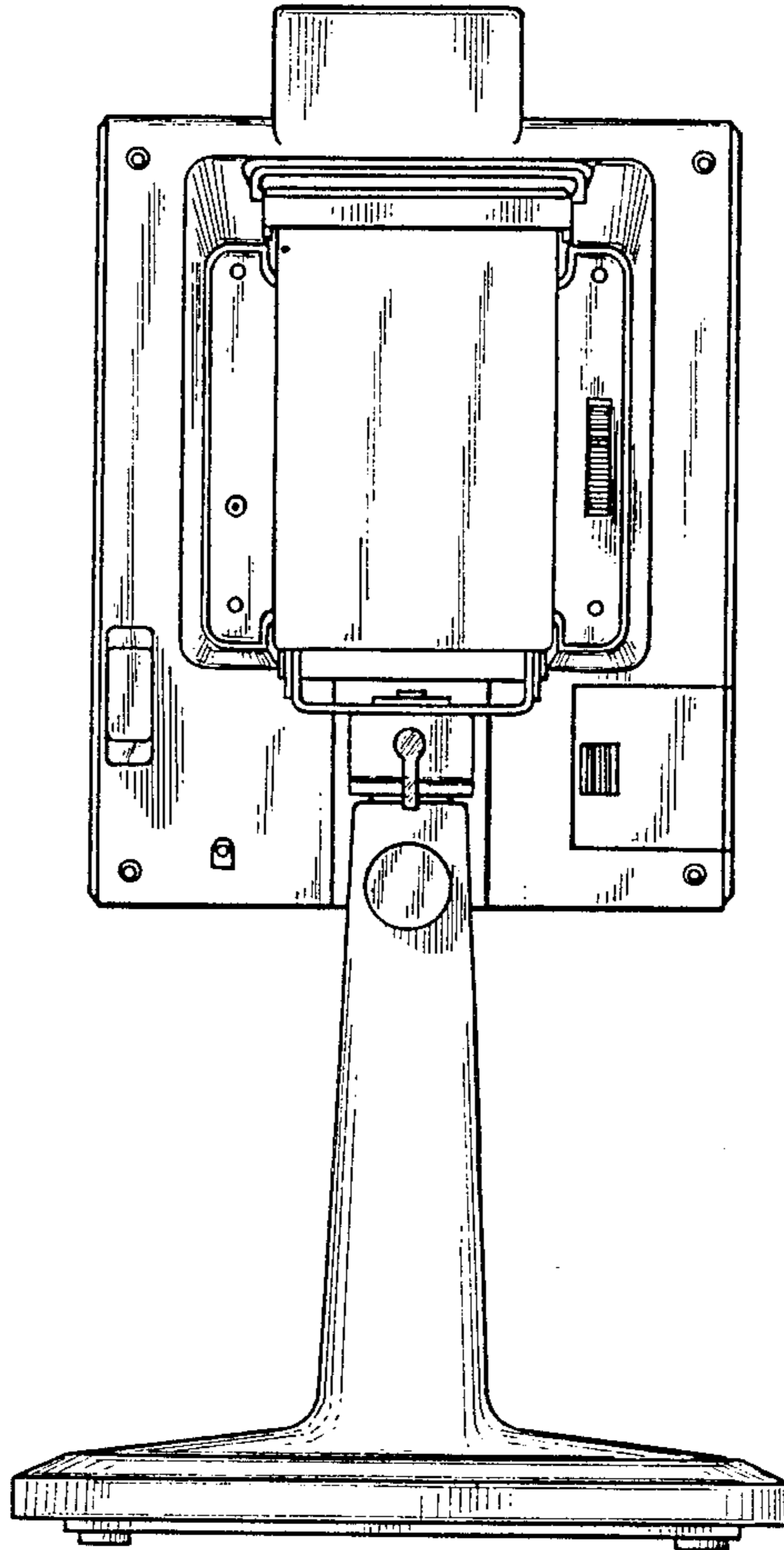

FIG. 3

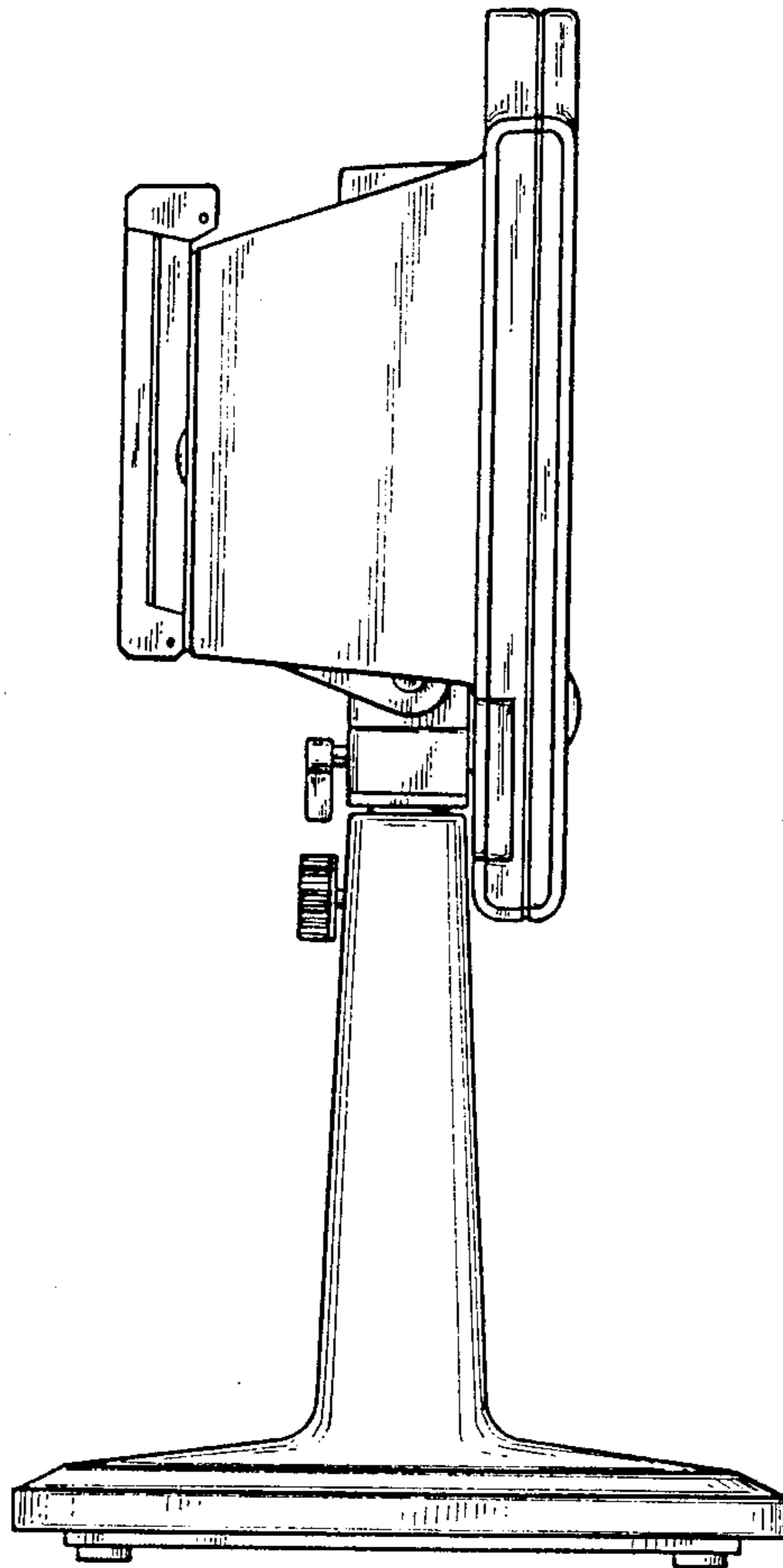
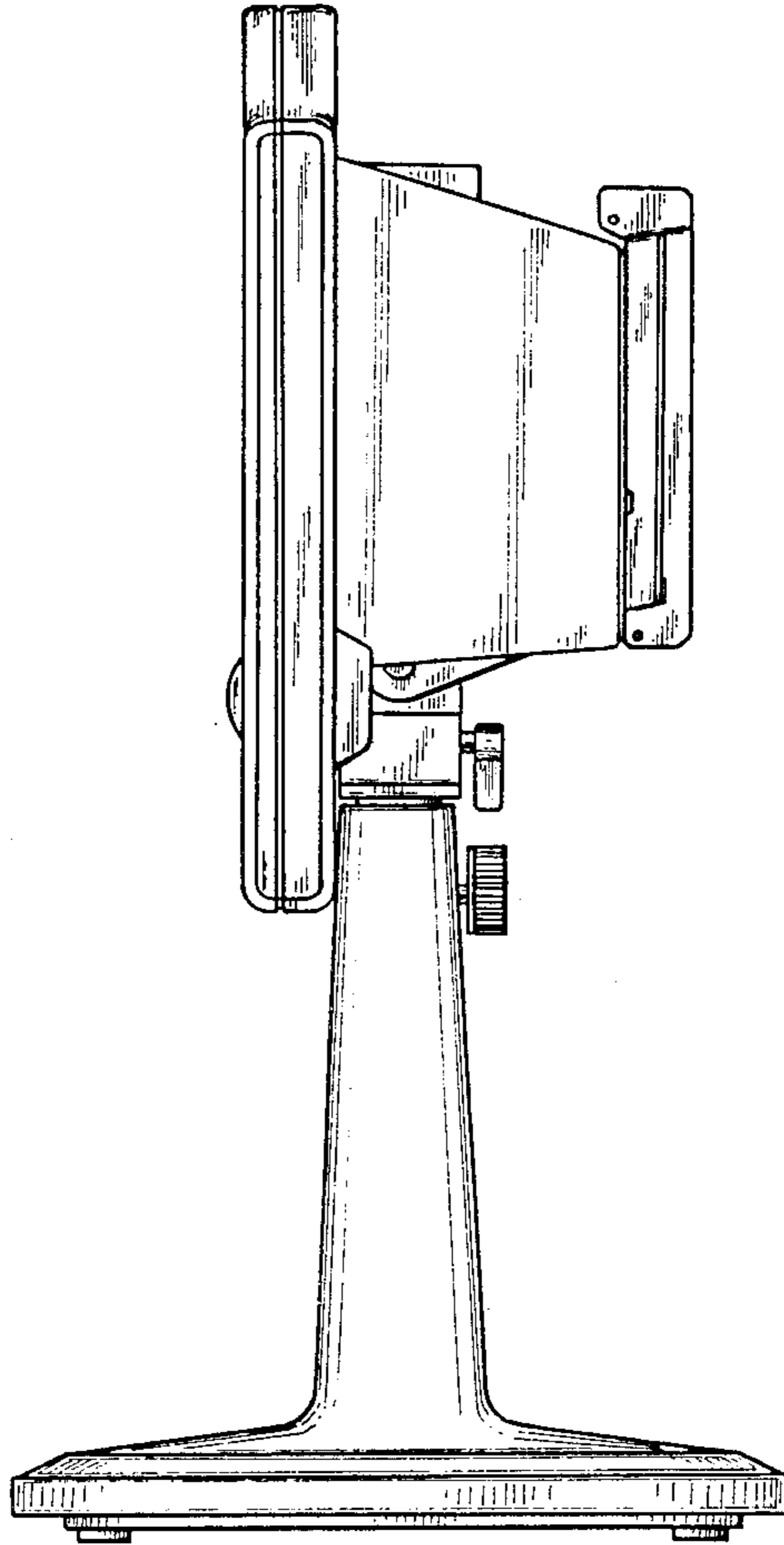
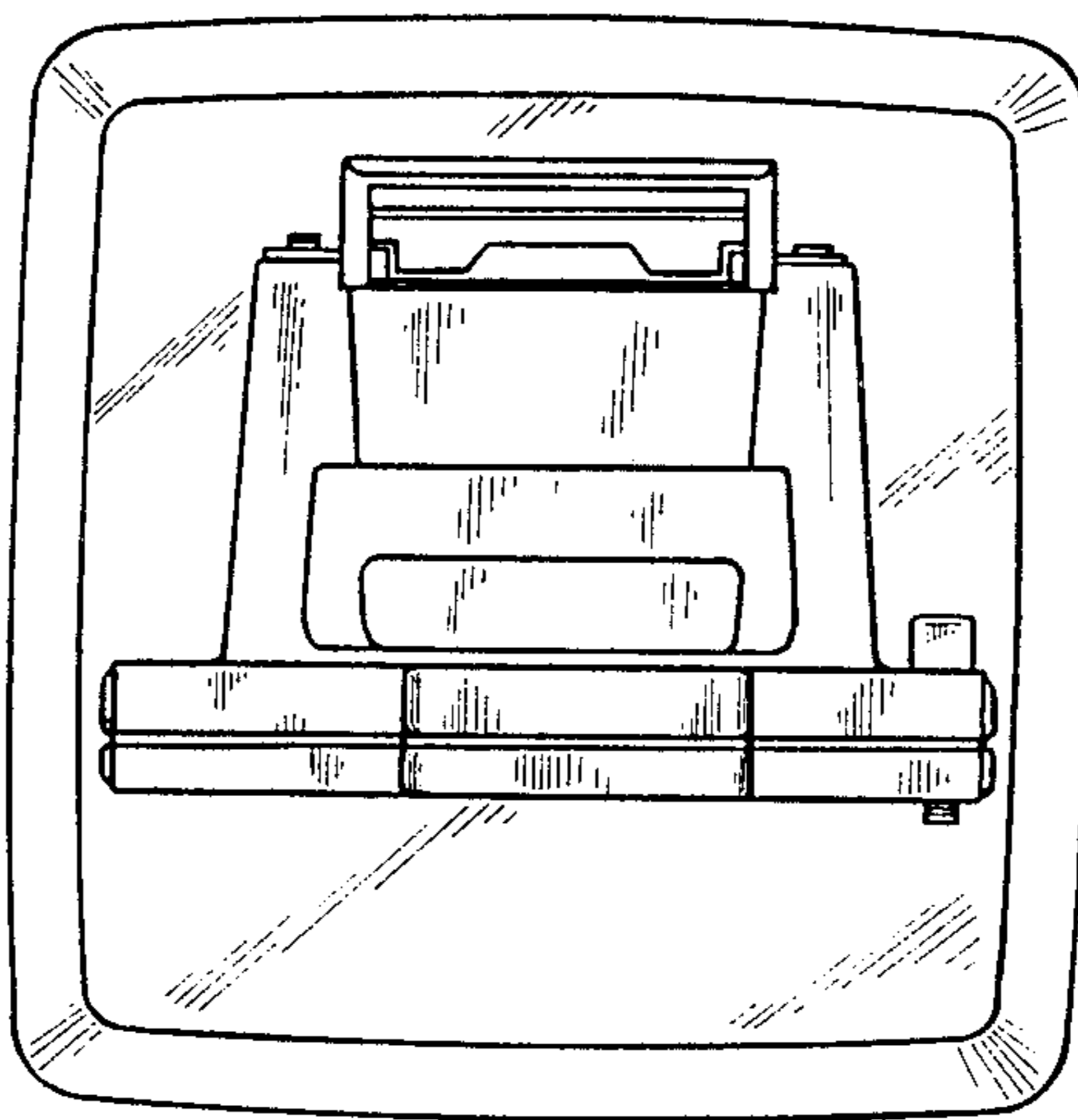

FIG. 4



FIG_5



FIG_6

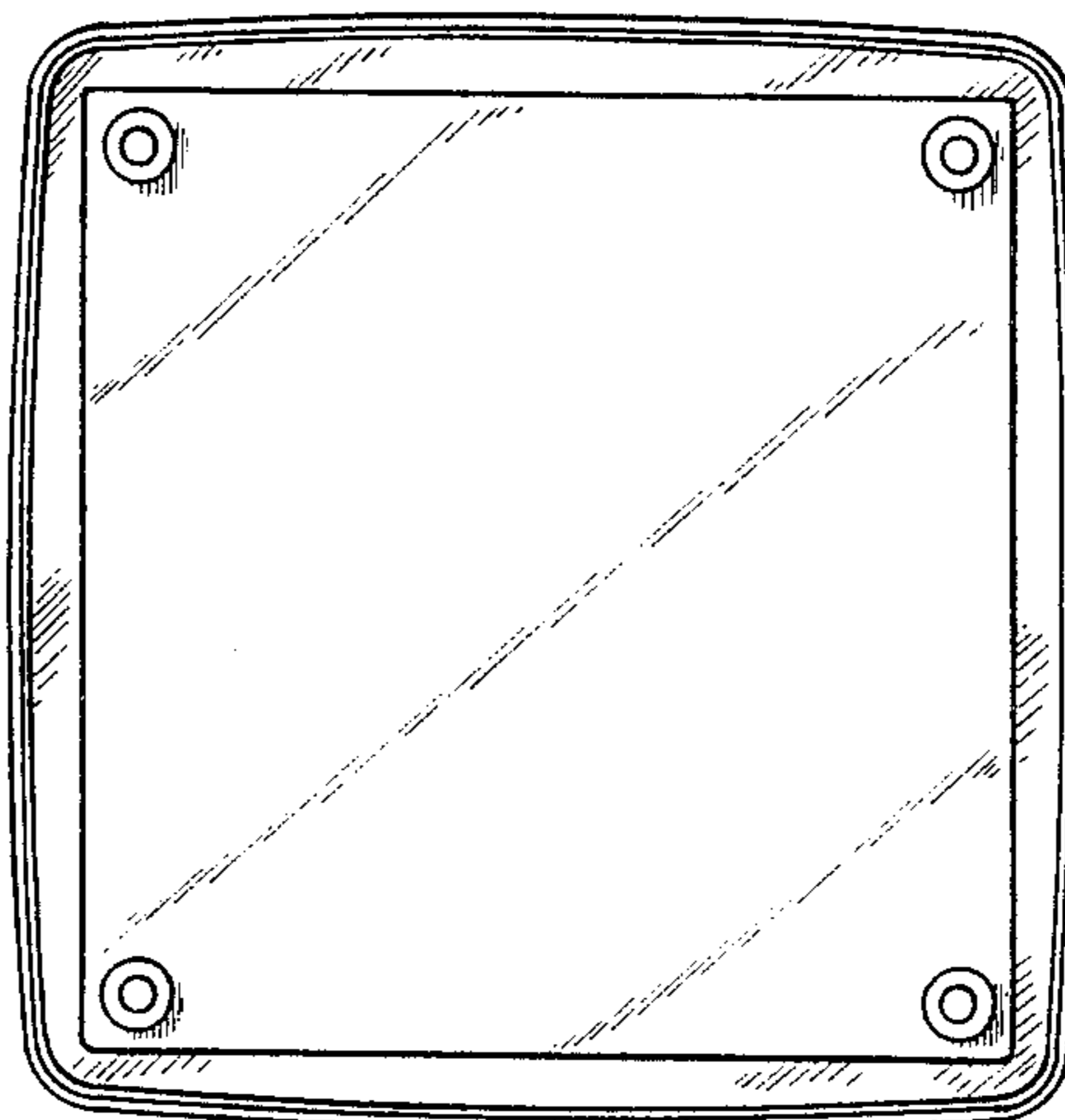

FIG 7

