

[54] EXTERIOR SHELL OF A TRUCK CAB STEP UNIT

[75] Inventors: Theresa D. Preslik; Ross Sasamura, both of Fremont, Calif.

[73] Assignee: Paccar Inc., Bellevue, Wash.

[*] Notice: The portion of the term of this patent subsequent to Dec. 4, 2004 has been disclaimed.

[**] Term: 14 Years

[21] Appl. No.: 94,926

[22] Filed: Sep. 9, 1987

[52] U.S. Cl. D12/203

[58] Field of Search D12/96, 203; 296/183, 296/193, 197; 280/163, 164.1

[56] References Cited

U.S. PATENT DOCUMENTS

D. 291,982	9/1987	Simons et al.	D12/96
3,224,525	12/1965	Froitzheim et al.	280/166
4,813,736	3/1989	Schubert et al.	280/163

OTHER PUBLICATIONS

Commercial Carrier Journal, 3/87, Carrier Advertisement Insert between pp. 32 & 33, Step Unit of Kenworth Tractor Cab.

Commercial Carrier Journal, 3/87, rear cover, Step Unit of Peterbilt Tractor Cab.

Kenworth Brochure of Model T600A, ©1985, Step Unit on Tractor Cab.

Primary Examiner—James M. Gandy
Attorney, Agent, or Firm—Flehr, Hohbach, Test, Albritton & Herbert

[57] CLAIM

The ornamental design for an exterior shell of a truck cab step unit, as shown and described.

DESCRIPTION

FIG. 1 is a top, side perspective view of an exterior shell of a truck cab step unit showing our new design;

FIG. 2 is a top plan view thereof;

FIG. 3 is a side elevation view thereof;

FIG. 4 is a top, side perspective view of an exterior shell of a truck cab step unit showing a second embodiment of our new design;

FIG. 5 is a top plan view of FIG. 4;

FIG. 6 is a side elevation view of FIG. 4;

FIG. 7 is a top, side perspective view of an exterior shell of a truck cab step unit showing a third embodiment of our new design;

FIG. 8 is a top plan view of FIG. 7; and

FIG. 9 is a side elevation view of FIG. 7;

The broken line showing of a fragmentary portion of a truck cab is for illustrative purposes only and forms no part of the claimed design.

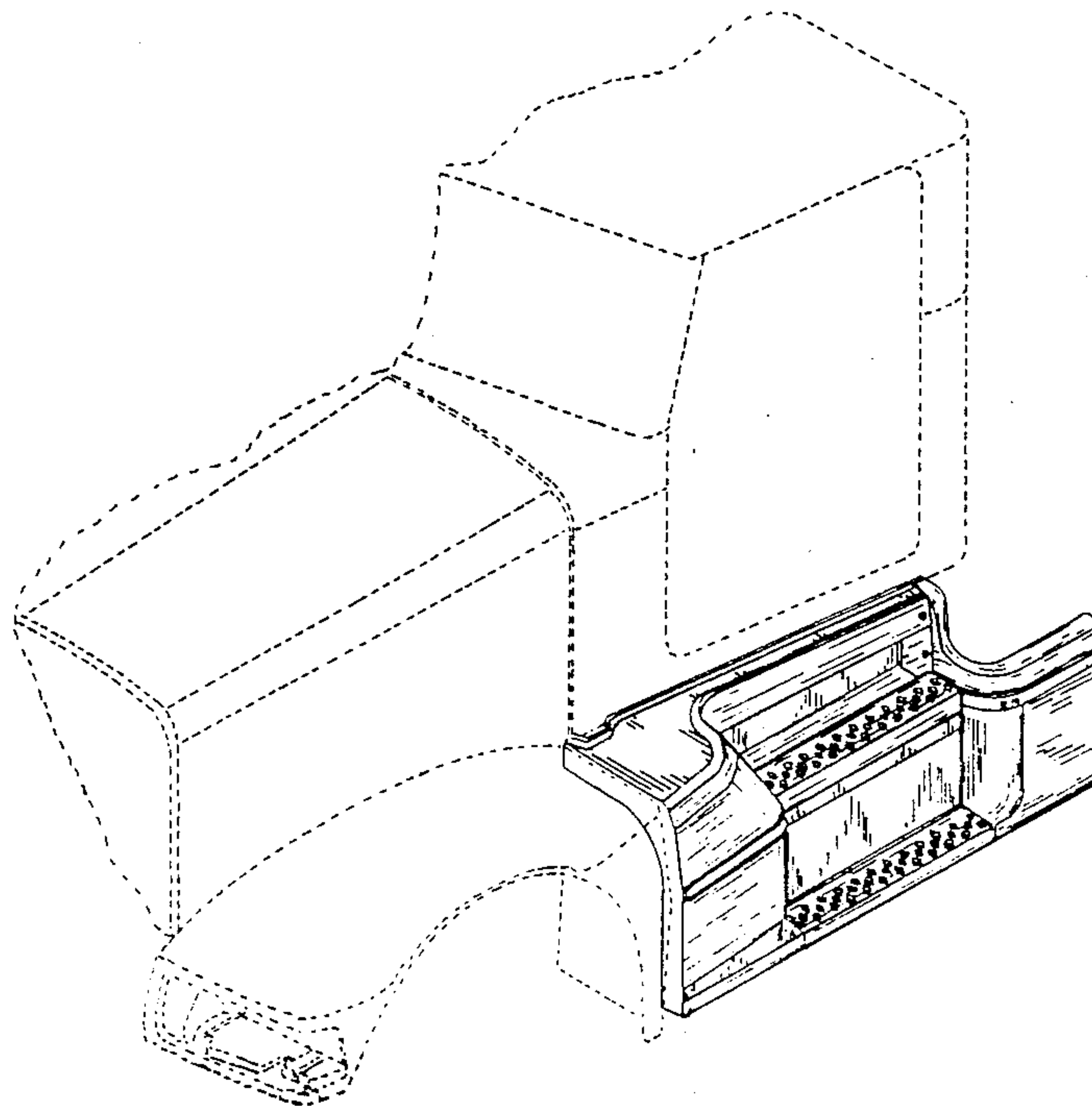

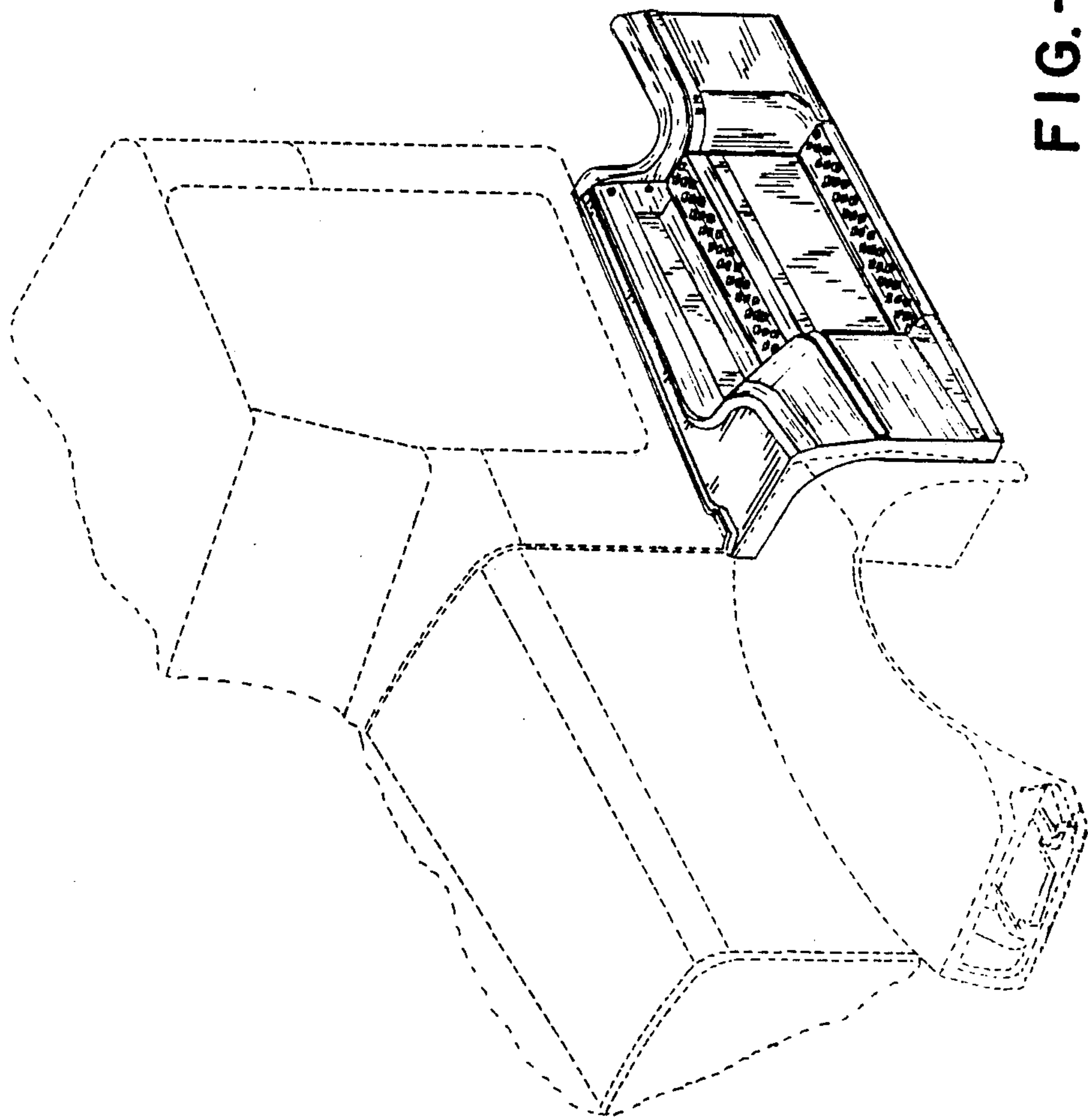

FIG. -1

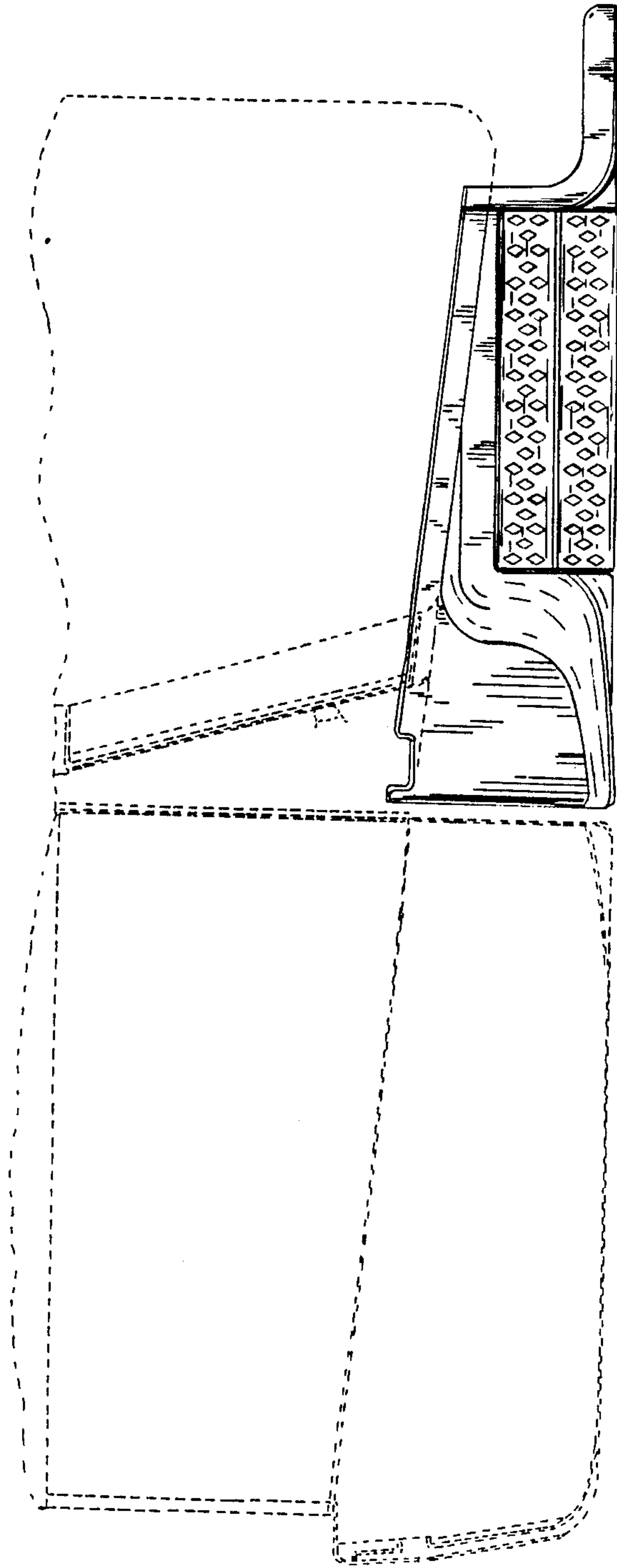

FIG. — 2

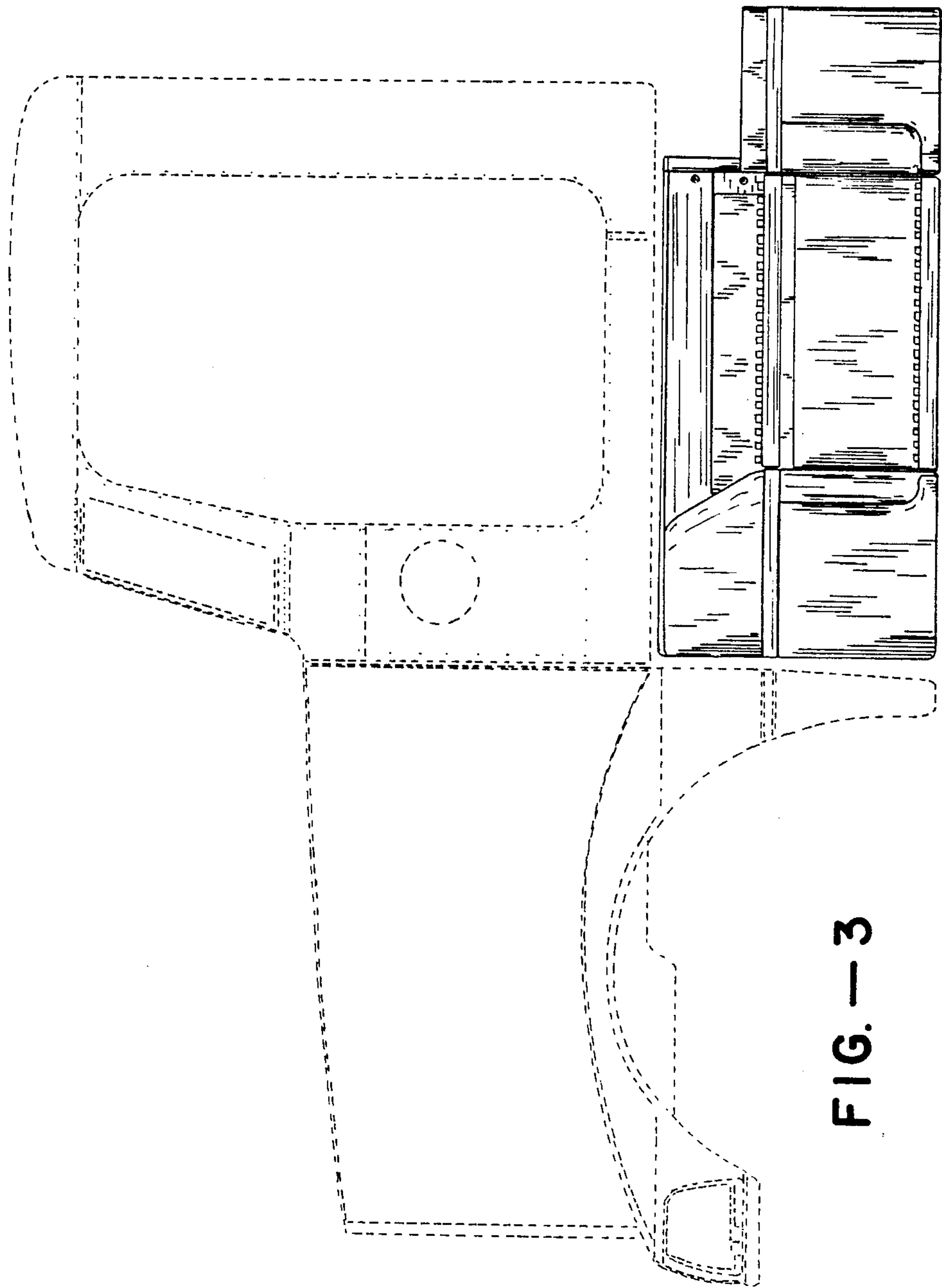

FIG. — 3

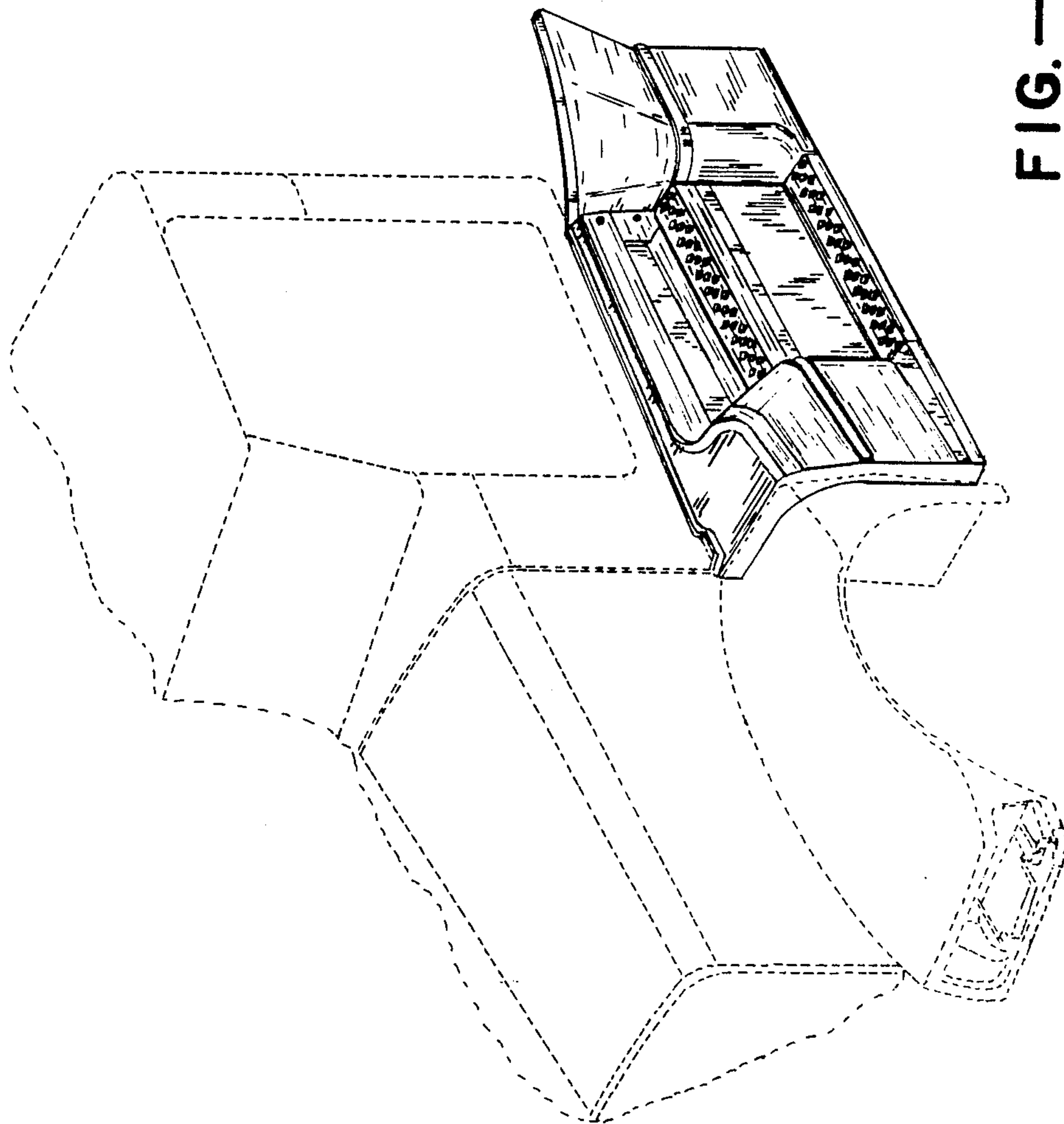

FIG. — 4

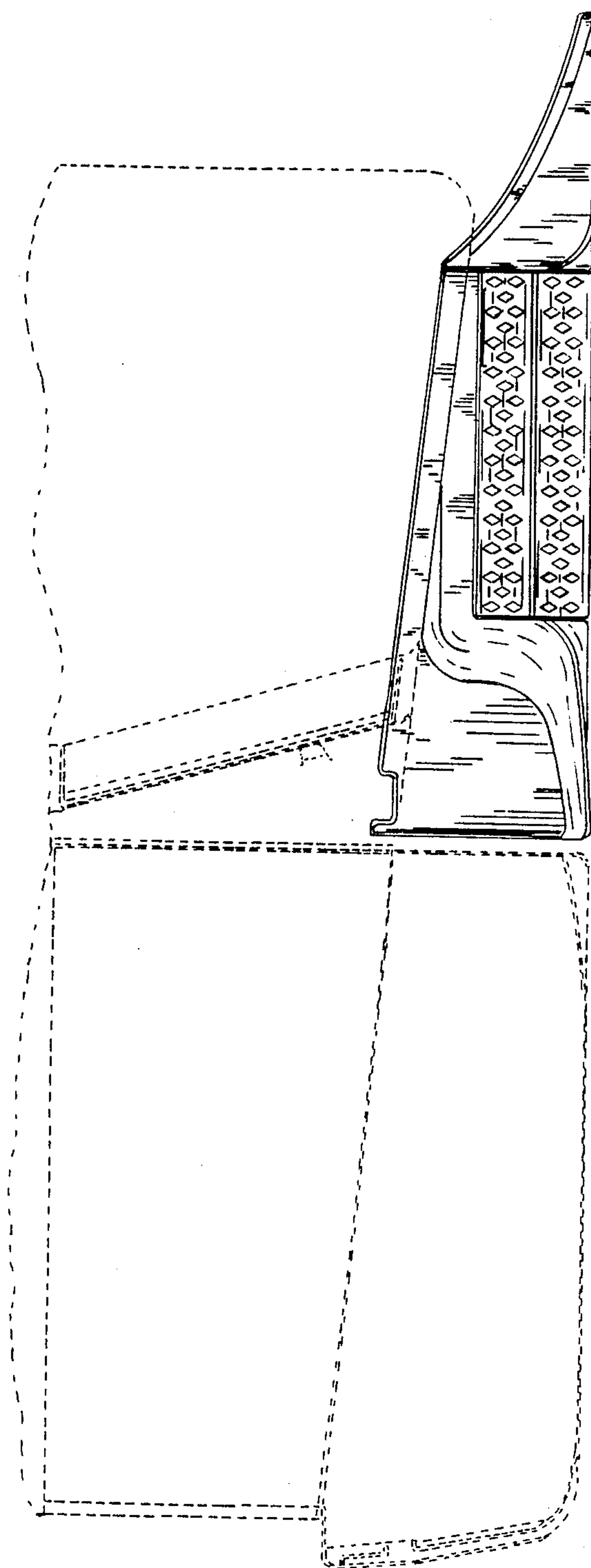

FIG. — 5

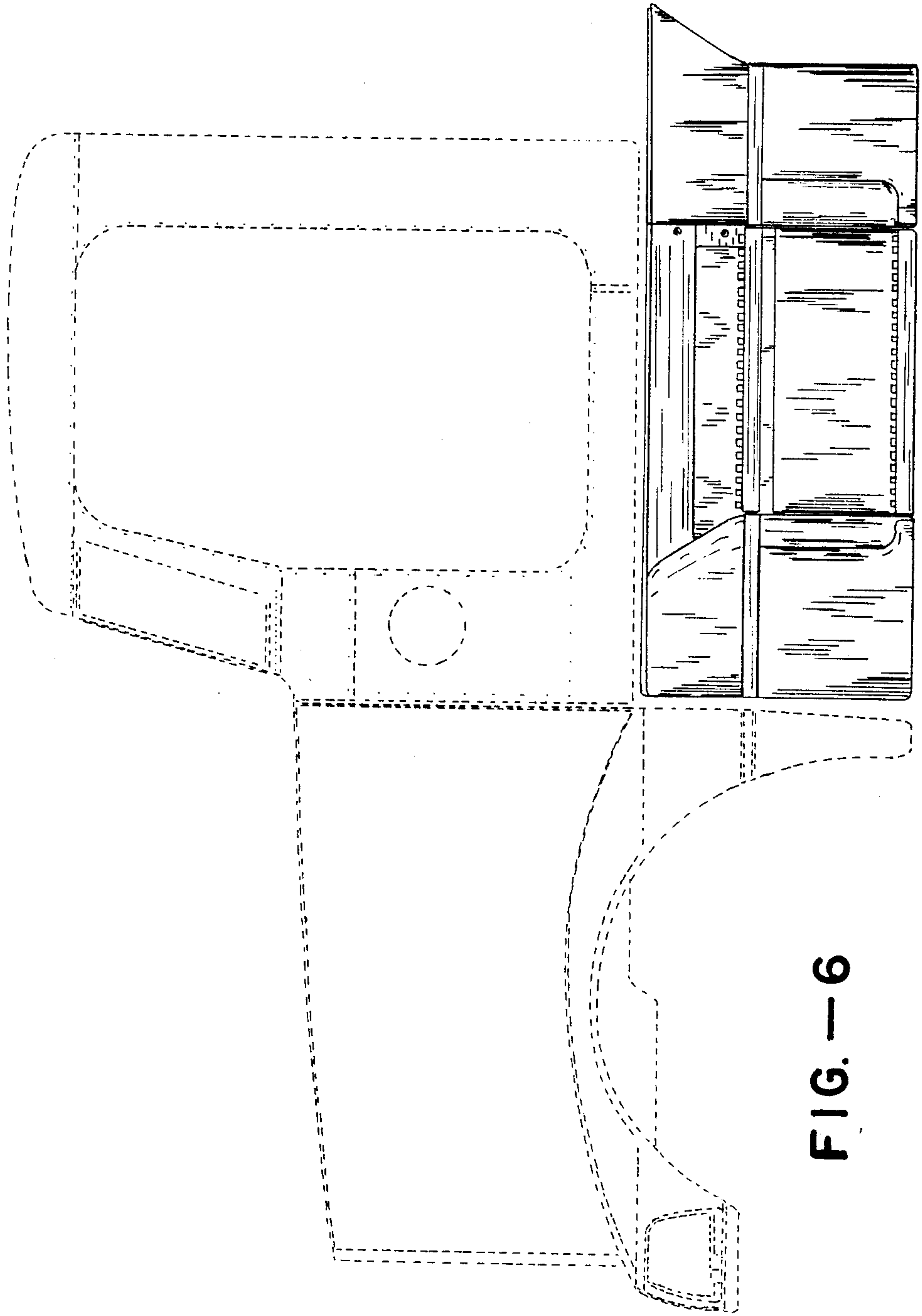

FIG. — 6

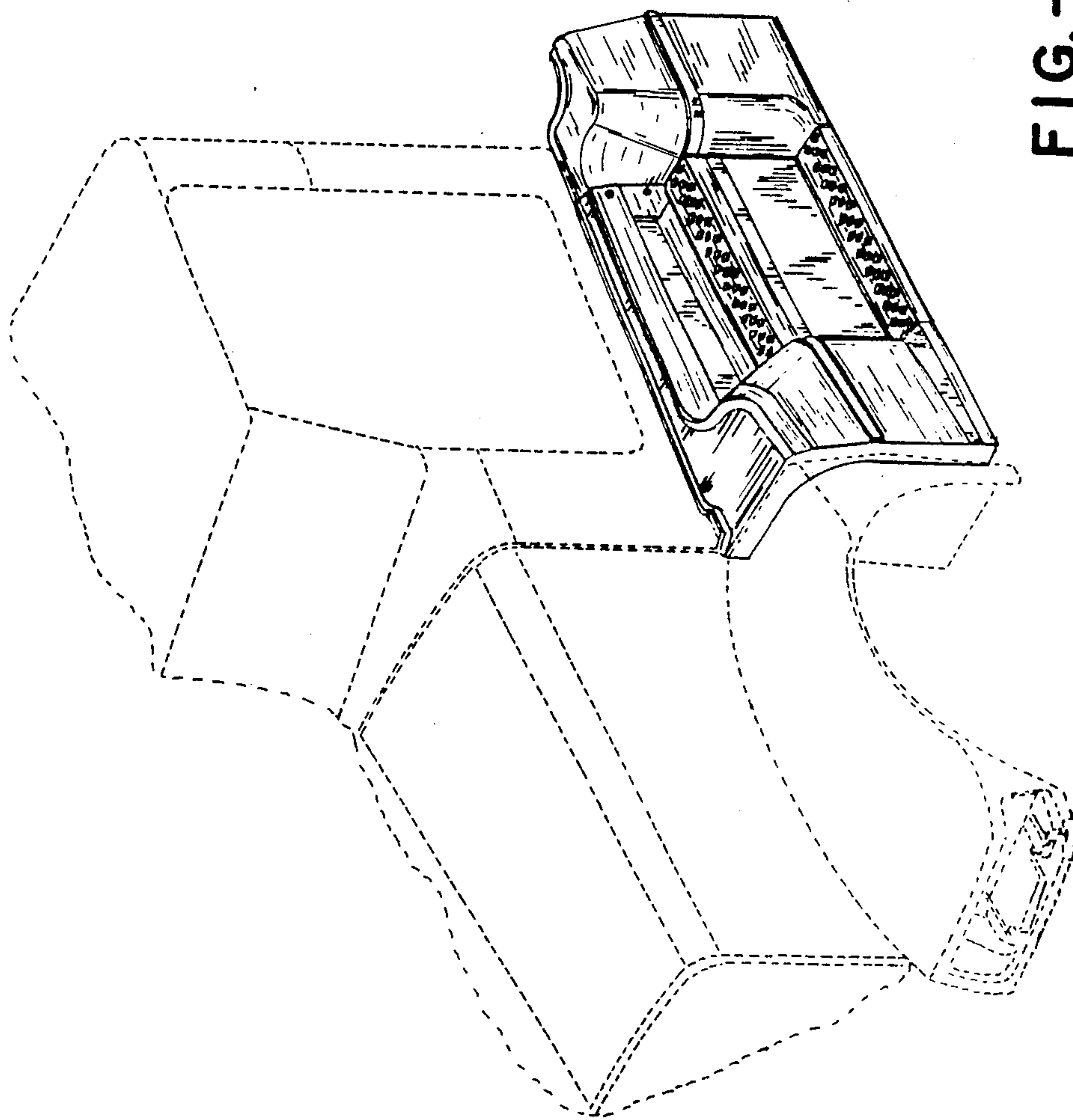

FIG.—7

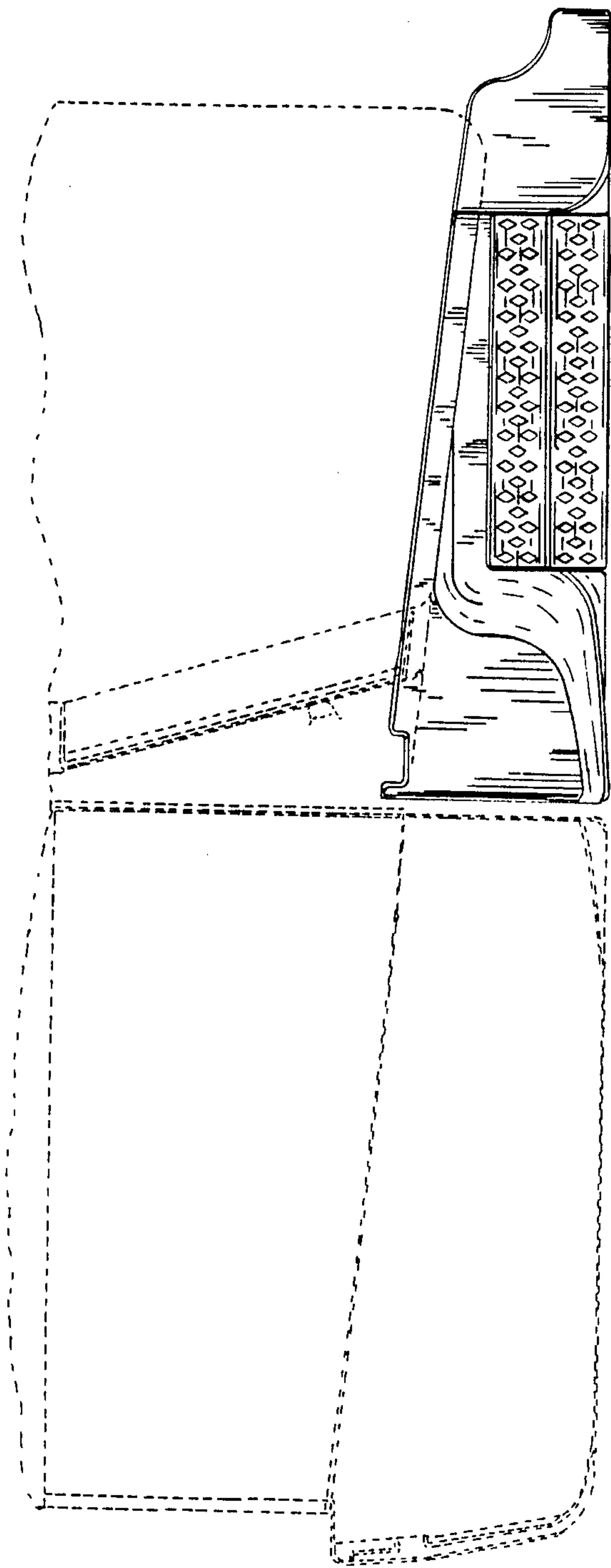

FIG. — 8

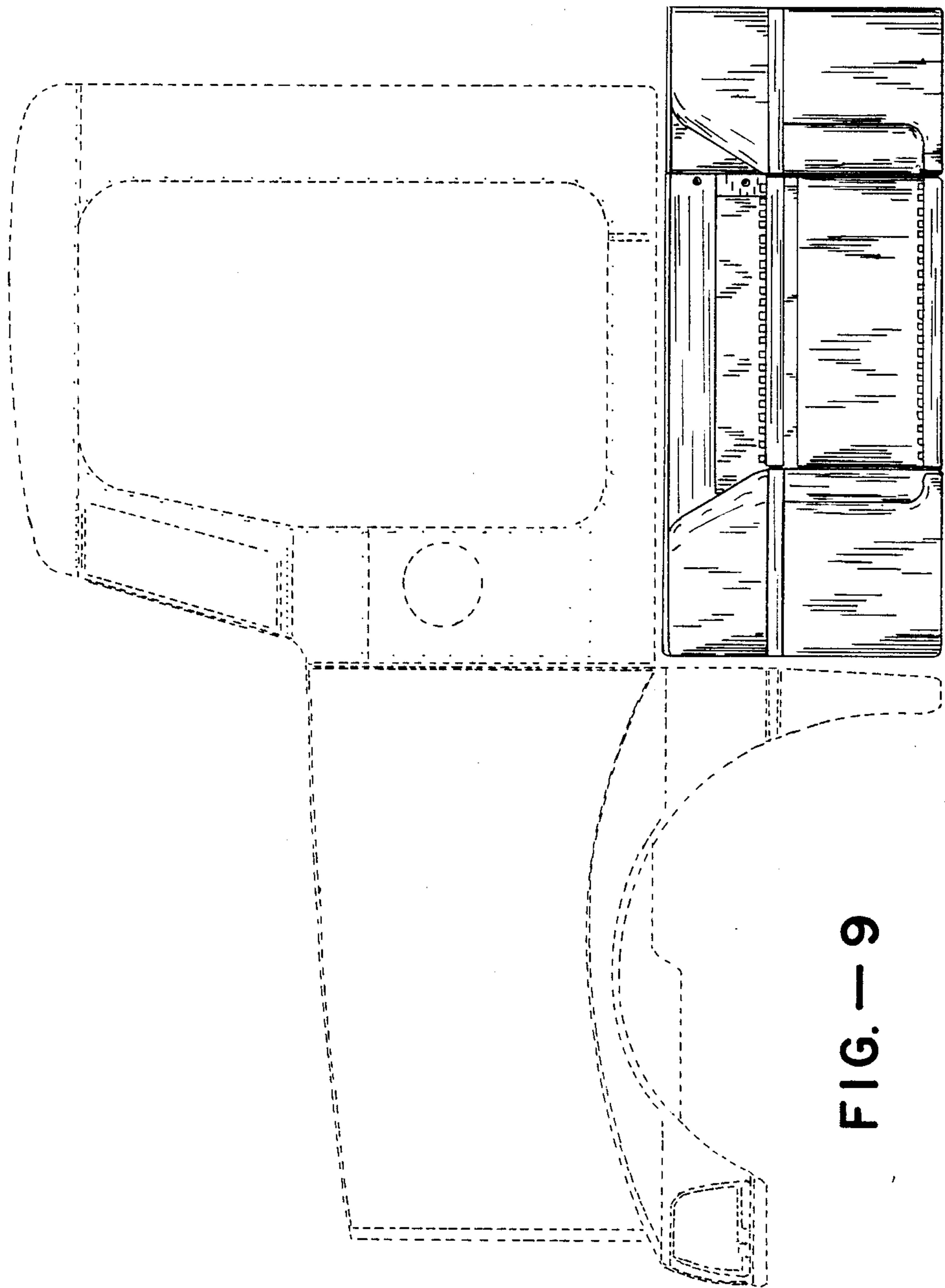

FIG. — 9