

[54] COVERED PITCHER OR THE LIKE

[75] Inventors: Robert H. C. M. Daenen, Erembodegem; Pieter J. K. DeCoster, Aalst, both of Belgium

[73] Assignee: Dart Industries Inc., Deerfield, Ill.

[**] Term: 14 Years

[21] Appl. No.: 152,599

[22] Filed: Feb. 2, 1988

[52] U.S. Cl. D7/317; D7/319

[58] Field of Search 222/130; D7/312, 316-319, D7/321, 622, 605, 500, 536, 533, 505

[56] References Cited

U.S. PATENT DOCUMENTS

D. 47,573	7/1915	Sanford	D7/502
D. 163,849	7/1951	Burroughs	D7/319
D. 184,760	3/1959	Ostrowsky	D7/538
D. 192,642	4/1962	Douglas	D7/317
D. 207,786	5/1967	Benes	D7/319 X
D. 215,749	10/1969	Adler	D7/317
D. 216,829	3/1970	Colato	D7/536
D. 255,080	5/1980	Gobleck, Jr.	D7/505
D. 255,531	6/1980	Daenen et al.	D10/46.2
D. 255,858	7/1980	Ashton	D7/533
D. 259,011	4/1981	Daenen	D7/316
D. 267,071	11/1982	Carlson	D7/612
D. 278,674	5/1985	Tardif et al.	D7/629
D. 290,324	6/1987	Ritman	D7/536
2,469,032	5/1949	Chaudron	222/130 X

Primary Examiner—Winifred E. Herrmann

Attorney, Agent, or Firm—John A. Doninger

[57] CLAIM

The ornamental design for a covered pitcher or the like, as shown and described.

DESCRIPTION

FIG. 1 is a top, front perspective view of a covered pitcher or the like showing a first embodiment of our new design;

FIG. 2 is a front elevational view of FIG. 1;

FIG. 3 is a rear elevational view of FIG. 1;

FIG. 4 is a right side elevational view of FIG. 1;

FIG. 5 is a left side elevational view of FIG. 1;

FIG. 6 is a top plan view of FIG. 1;

FIG. 7 is a top bottom view of FIG. 1;

FIG. 8 is a top, front perspective view of a second embodiment of our new design for a covered pitcher or the like;

FIG. 9 is a front elevational view of FIG. 8;

FIG. 10 is a rear elevational view of FIG. 8;

FIG. 11 is a right side elevational view of FIG. 8;

FIG. 12 is a left side elevational view of FIG. 8;

FIG. 13 is a top plan view of FIG. 8;

FIG. 14 is a bottom plan view of FIG. 8;

FIG. 15 is a cross-sectional view taken along line 15—15 of FIG. 6;

FIG. 16 is a cross-sectional view taken along line 16—16 of FIG. 6;

FIG. 17 is a cross-sectional view taken along line 17—17 of FIG. 13; and

FIG. 18 is a cross-sectional view taken along line 18—18 of FIG. 13.

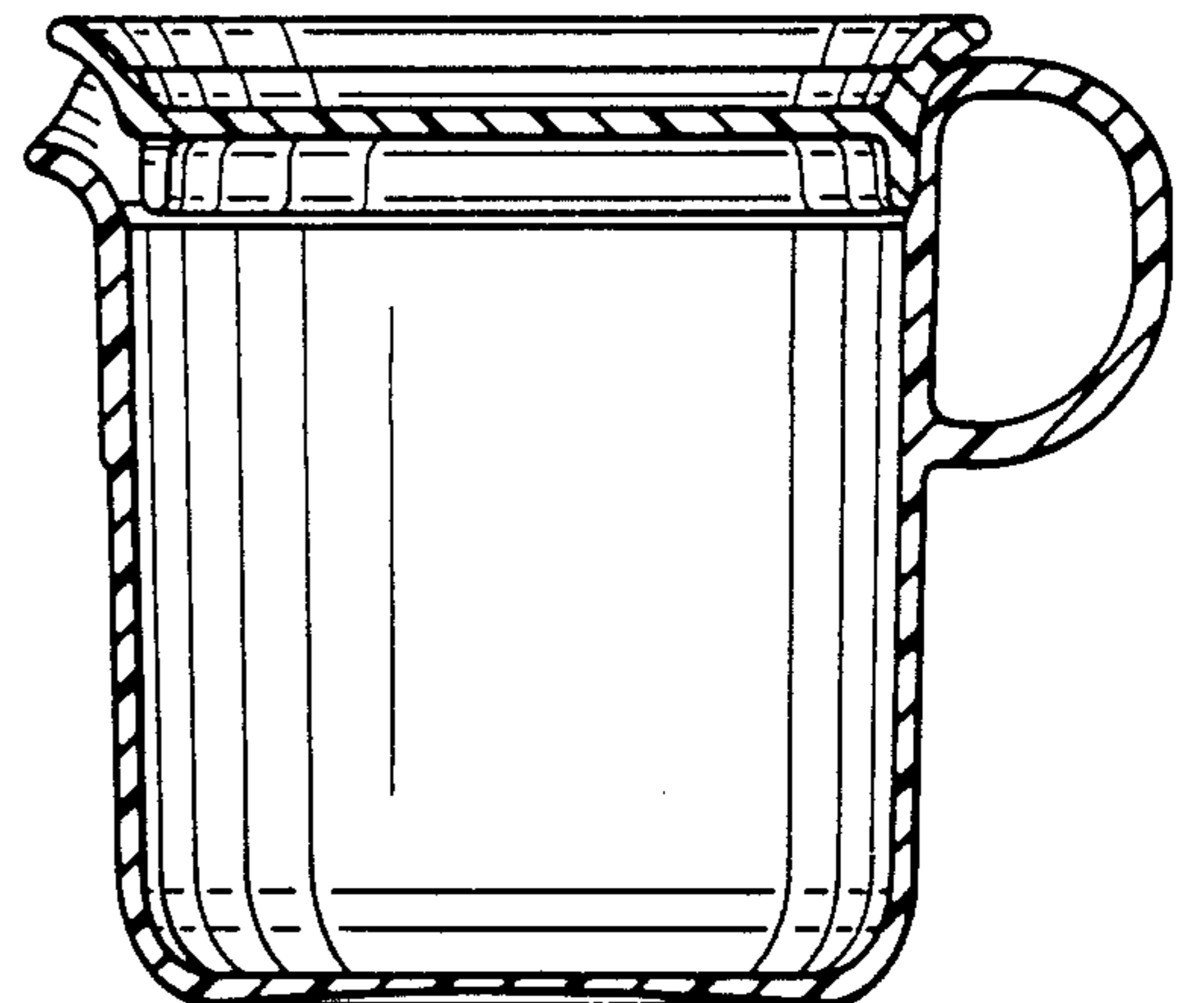
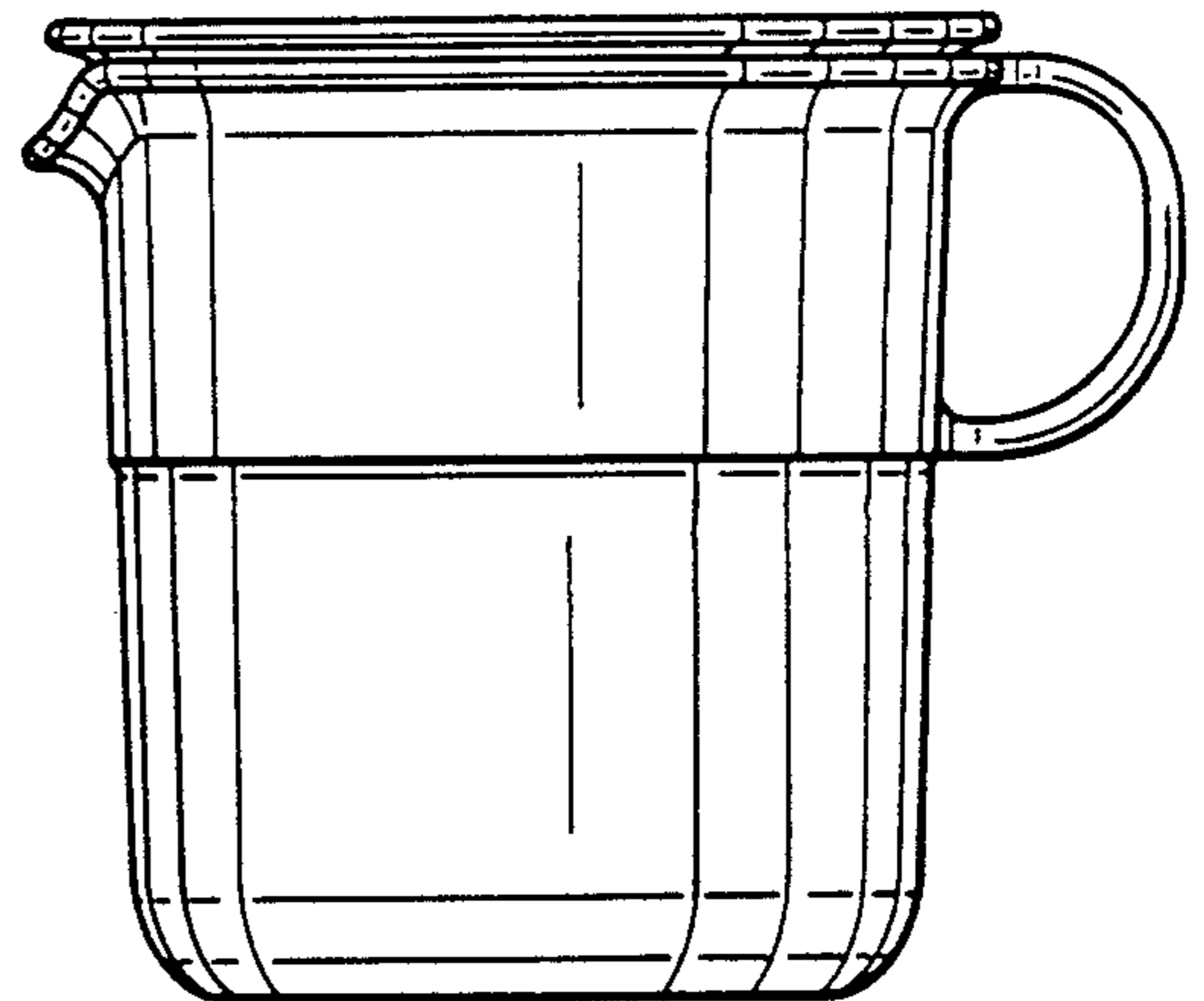
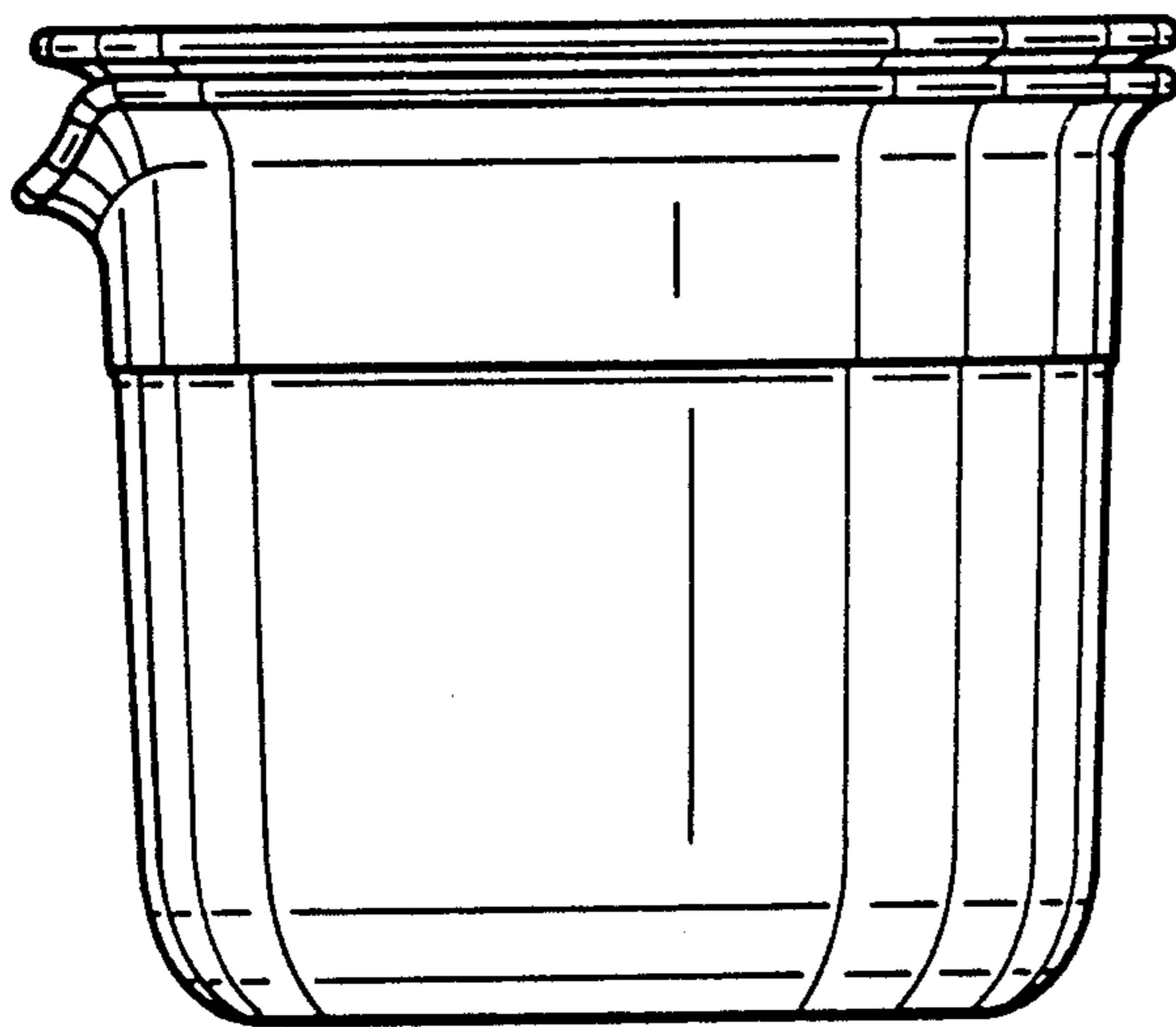

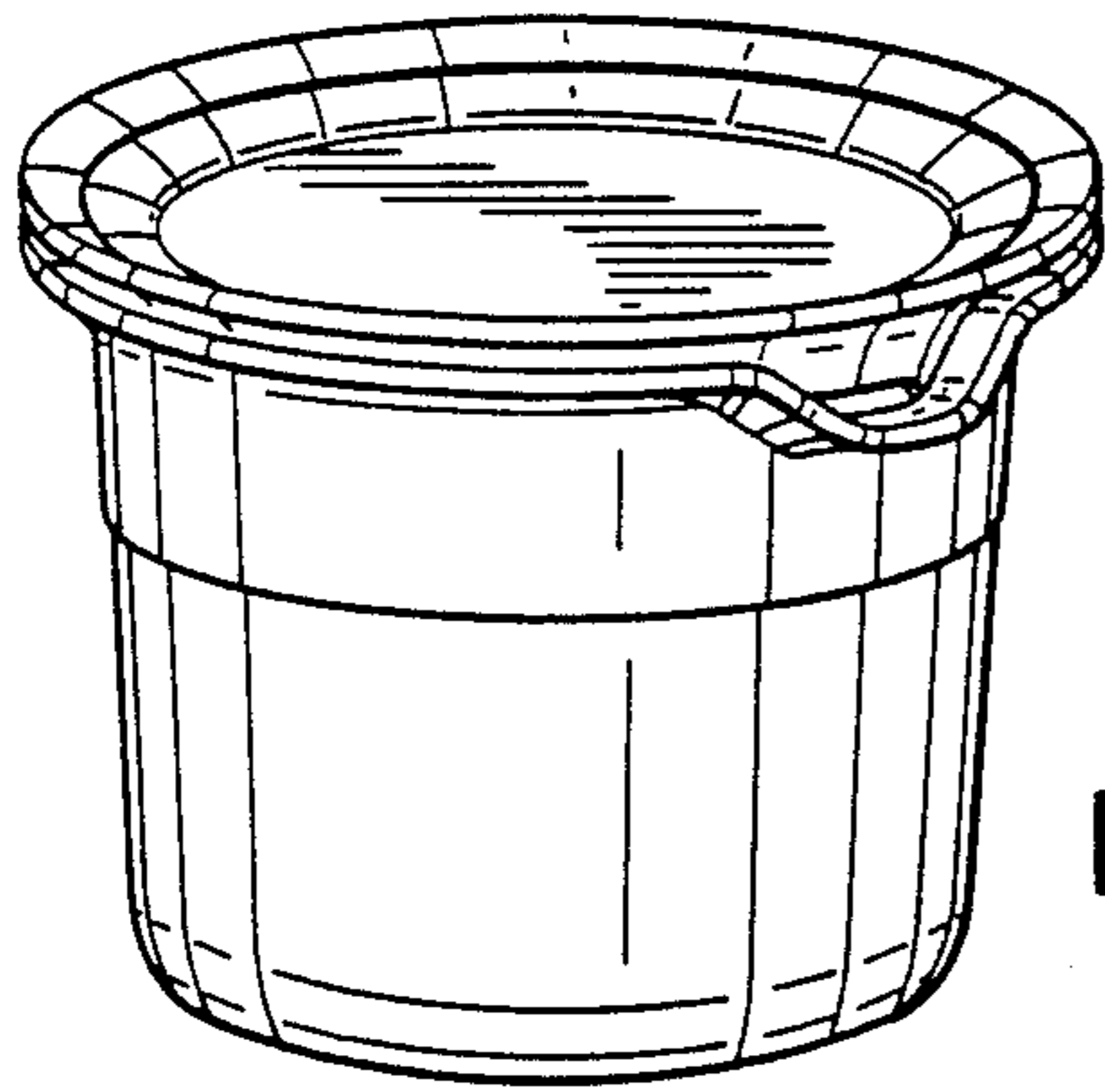

FIG. 1

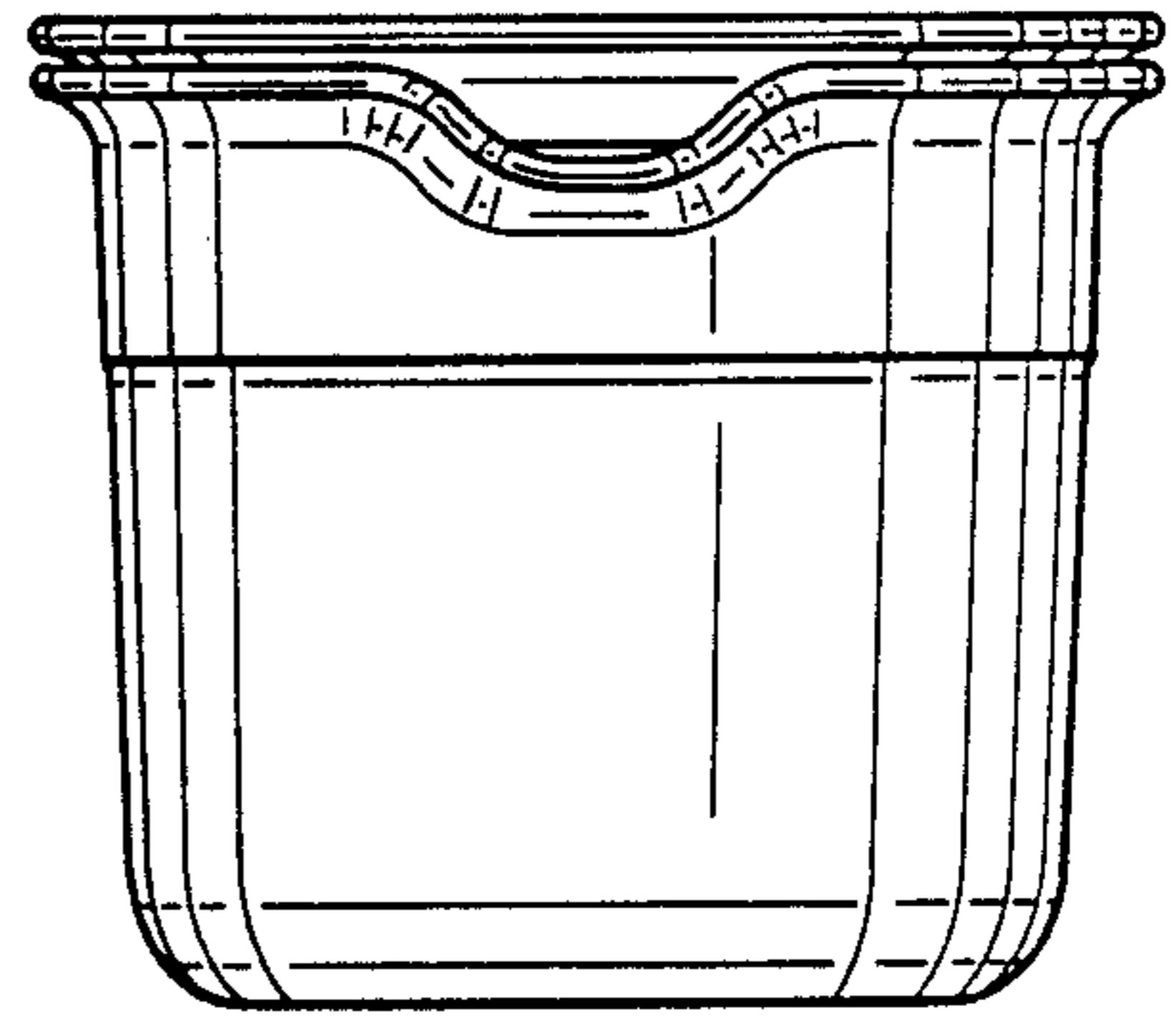

FIG. 2

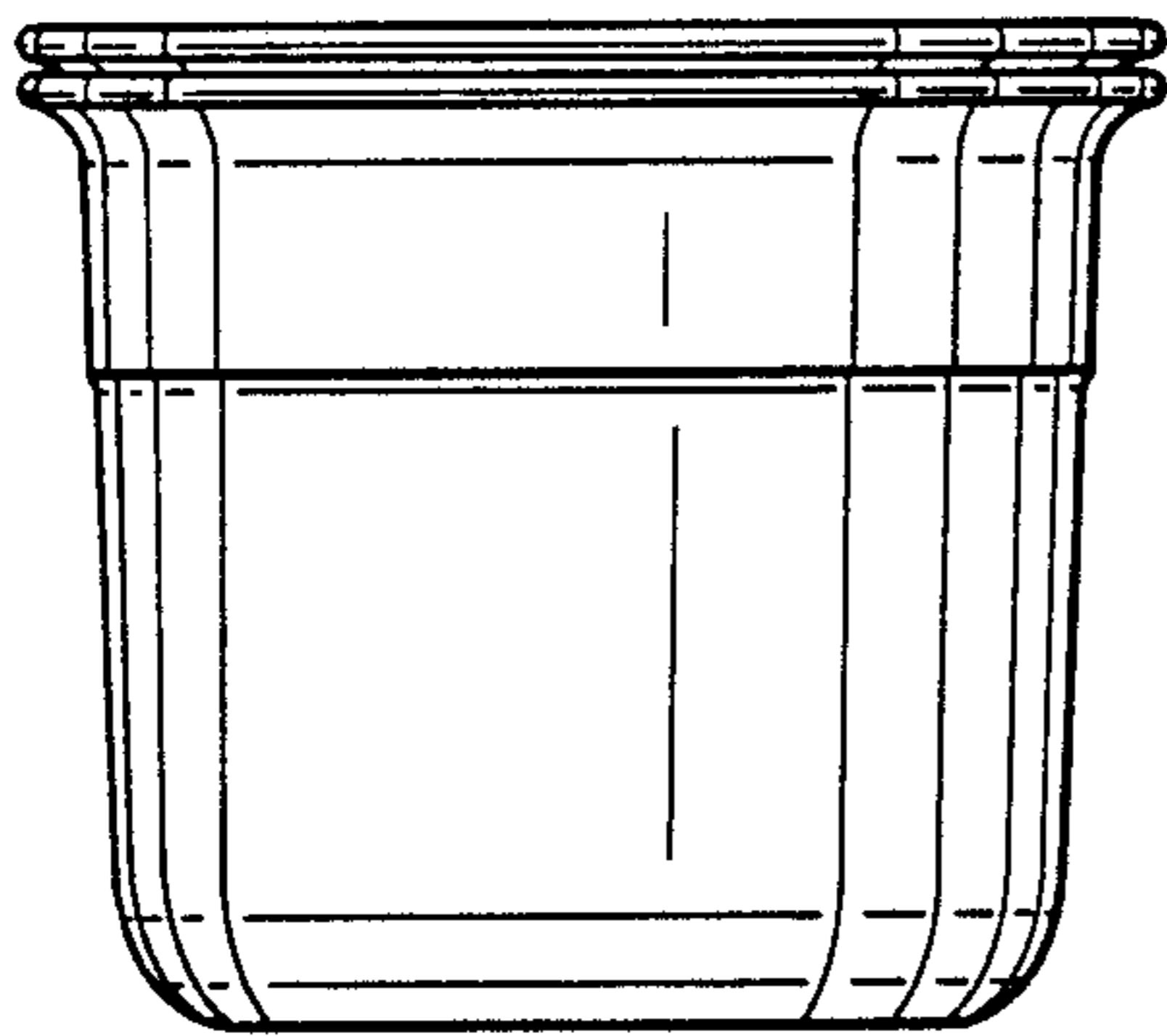

FIG. 3

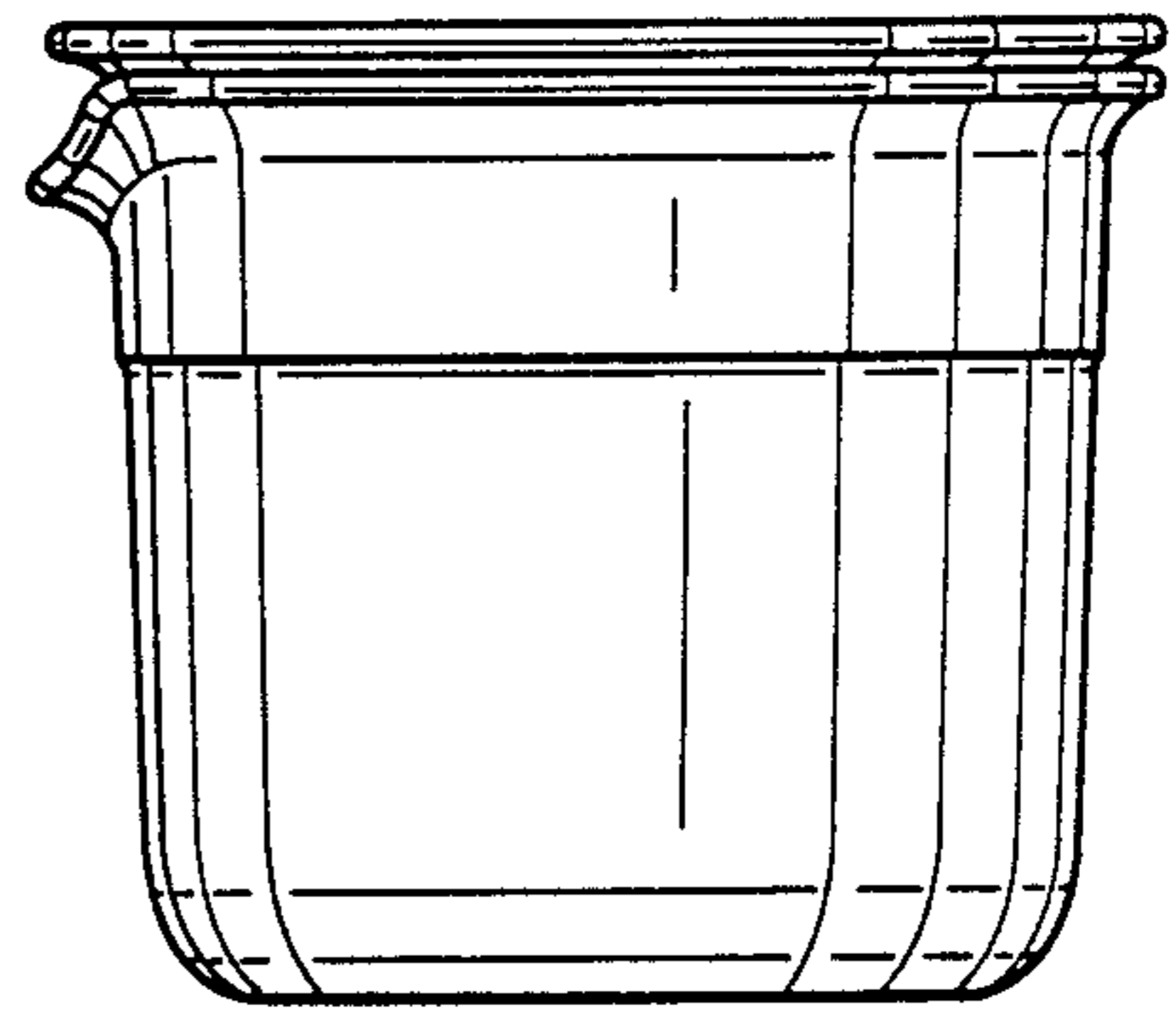

FIG. 4

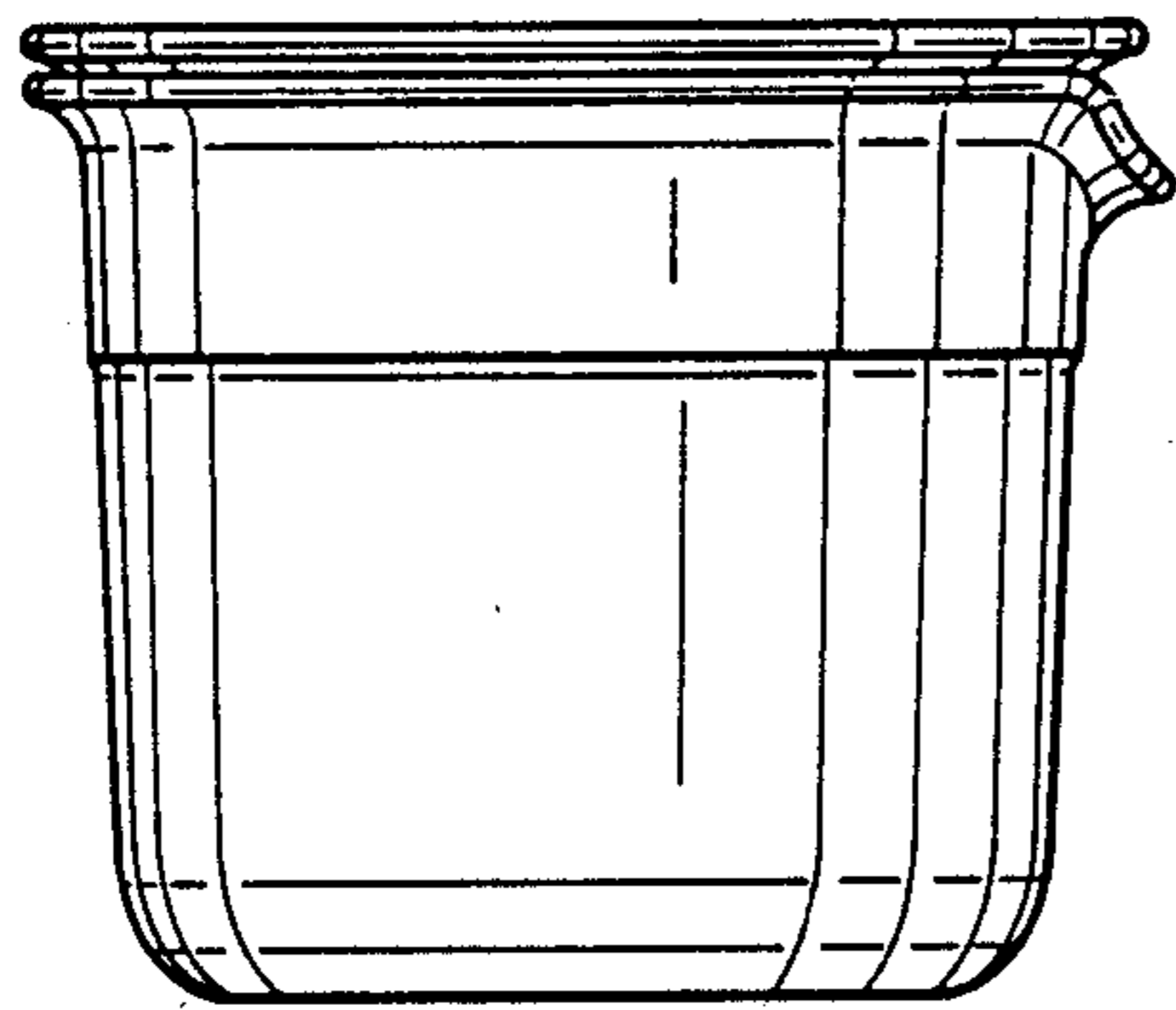

FIG. 5

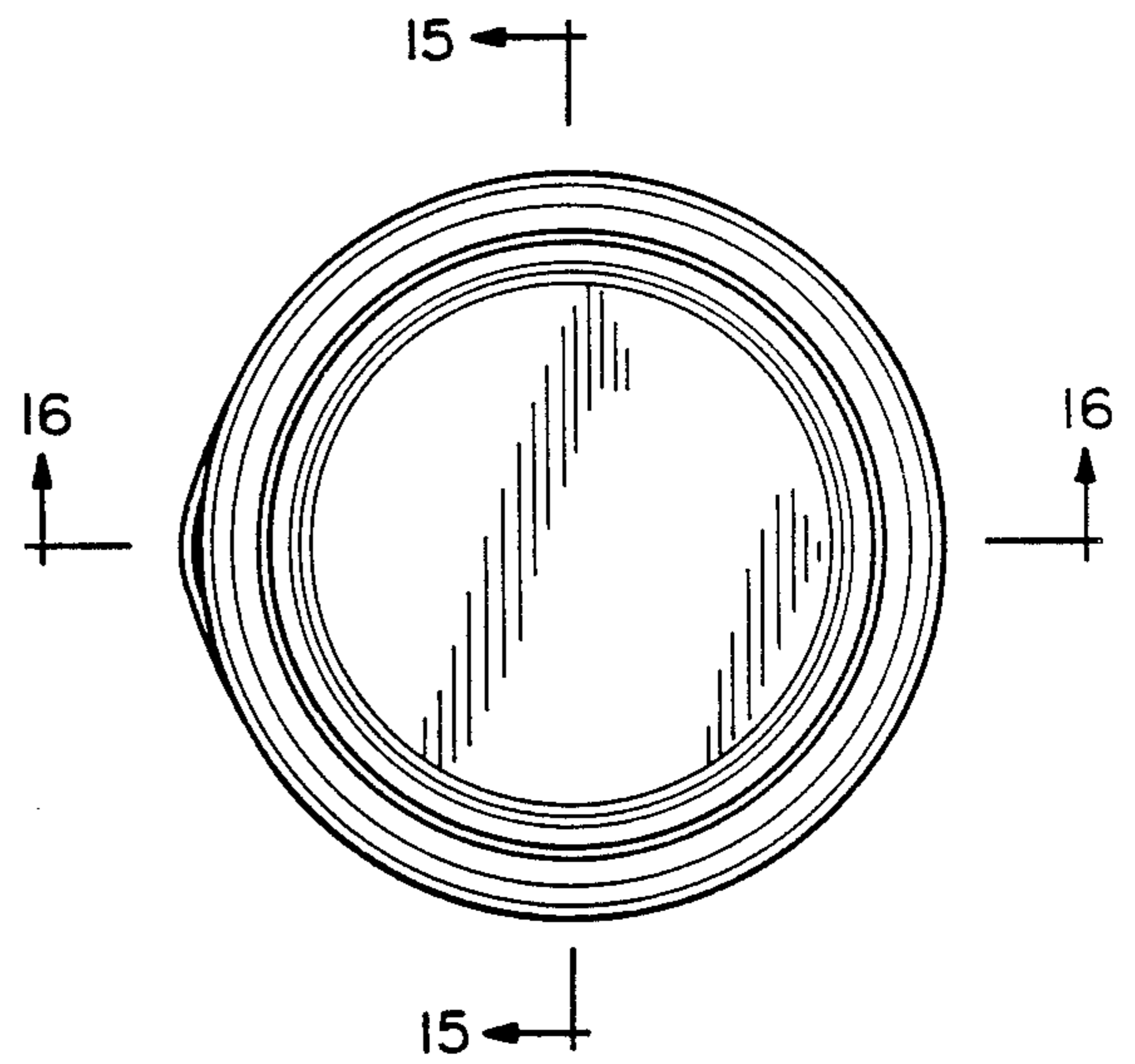

FIG. 6

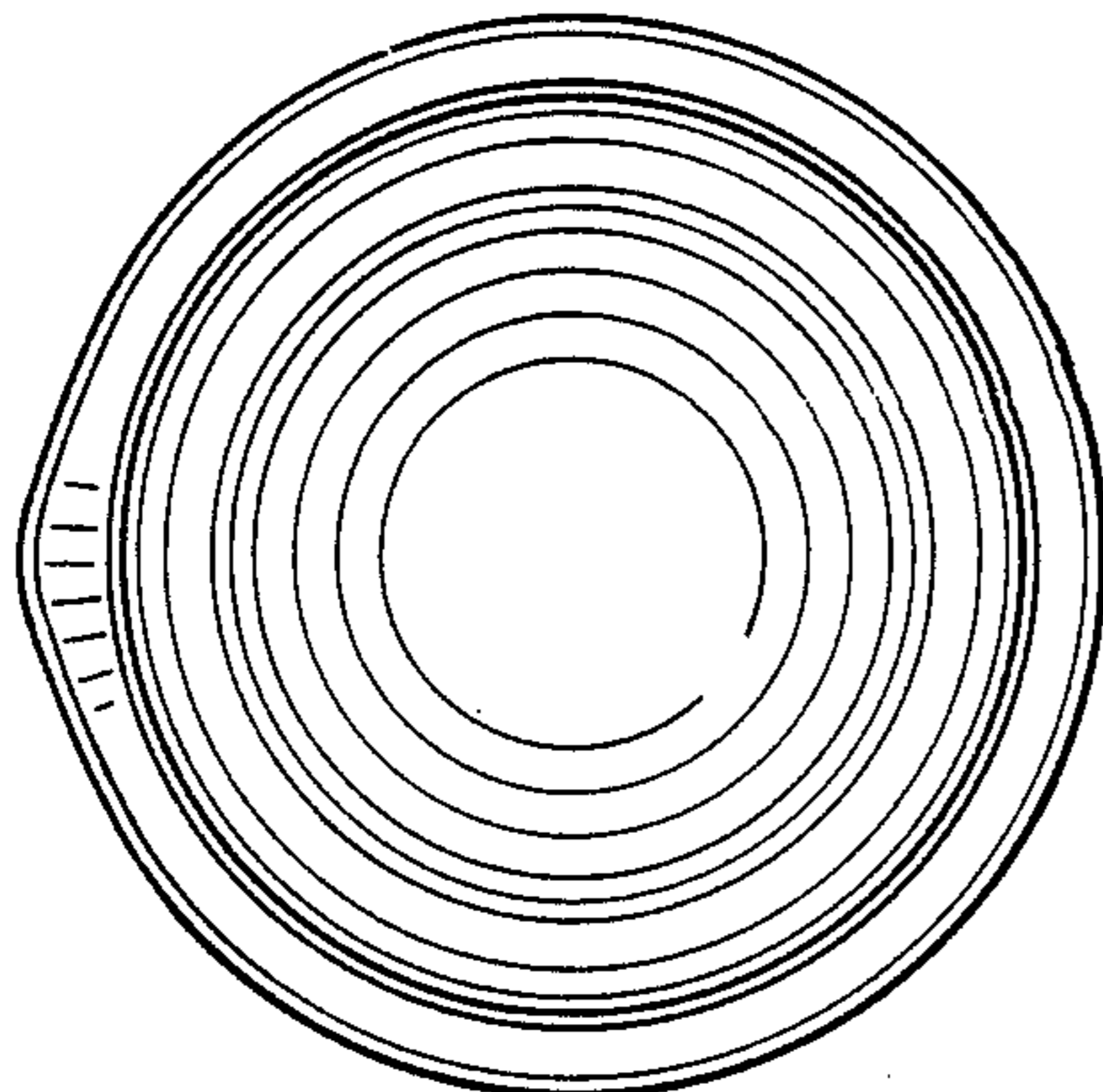

FIG. 7

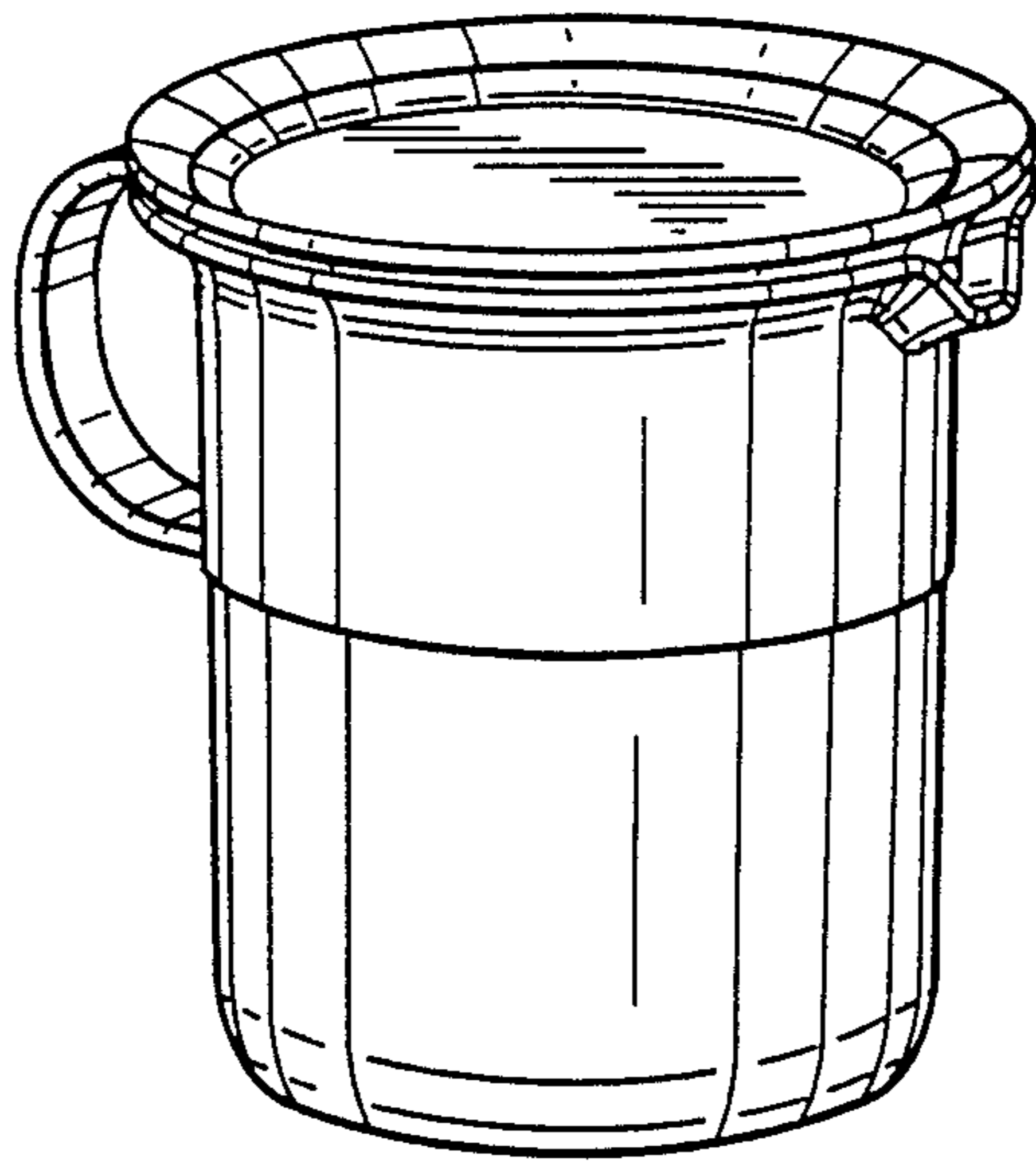

FIG. 8

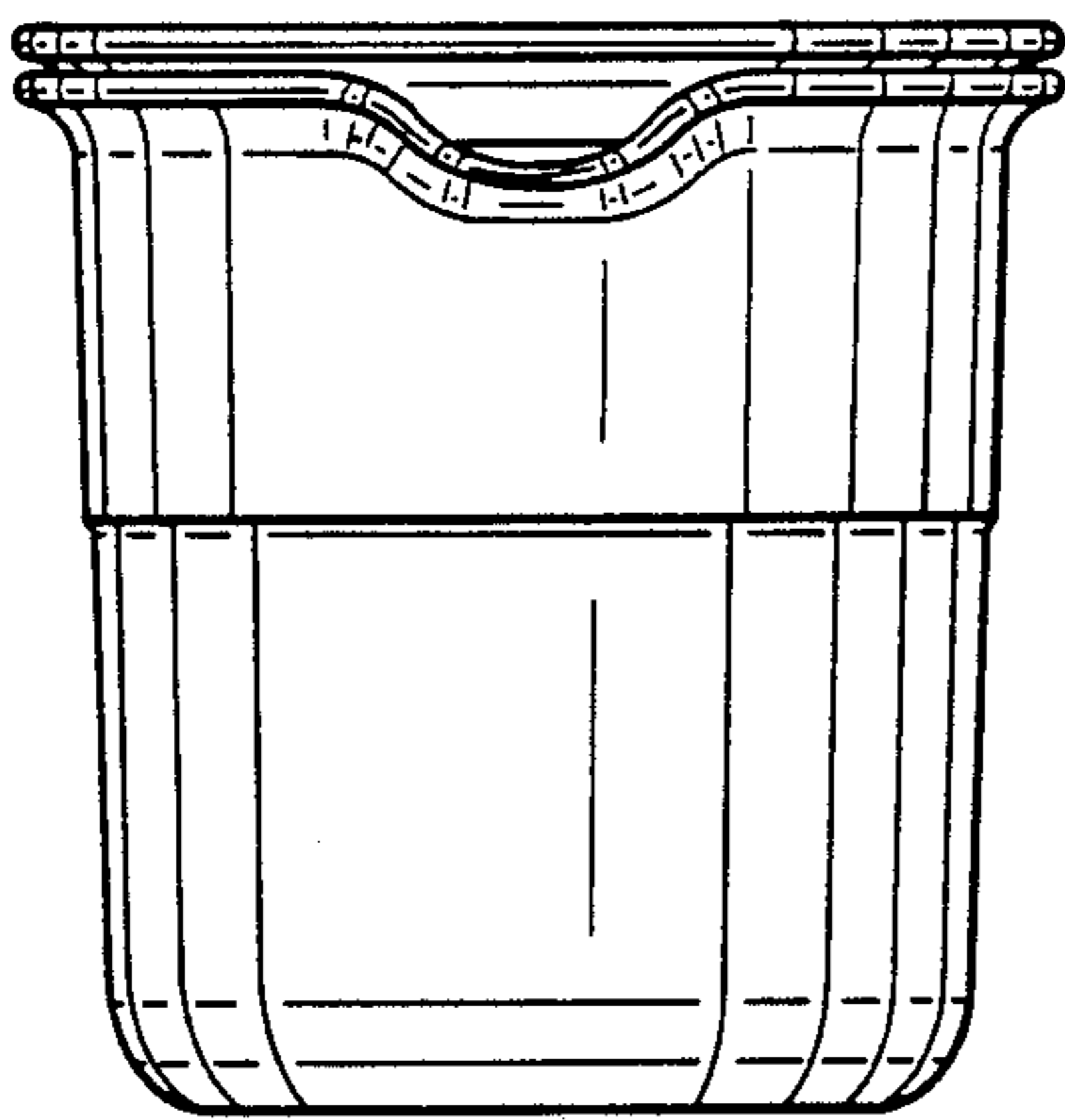

FIG. 9

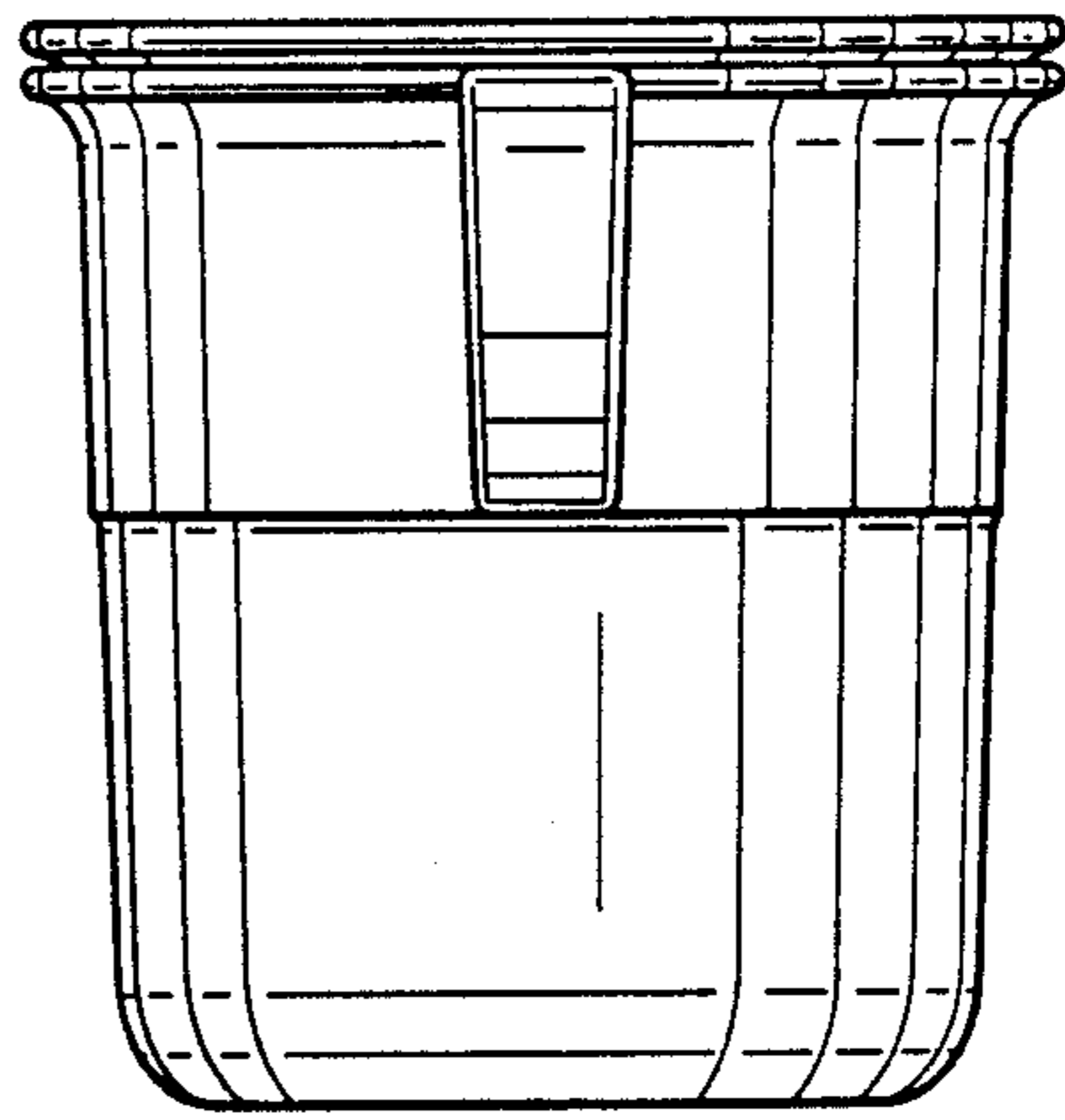

FIG. 10

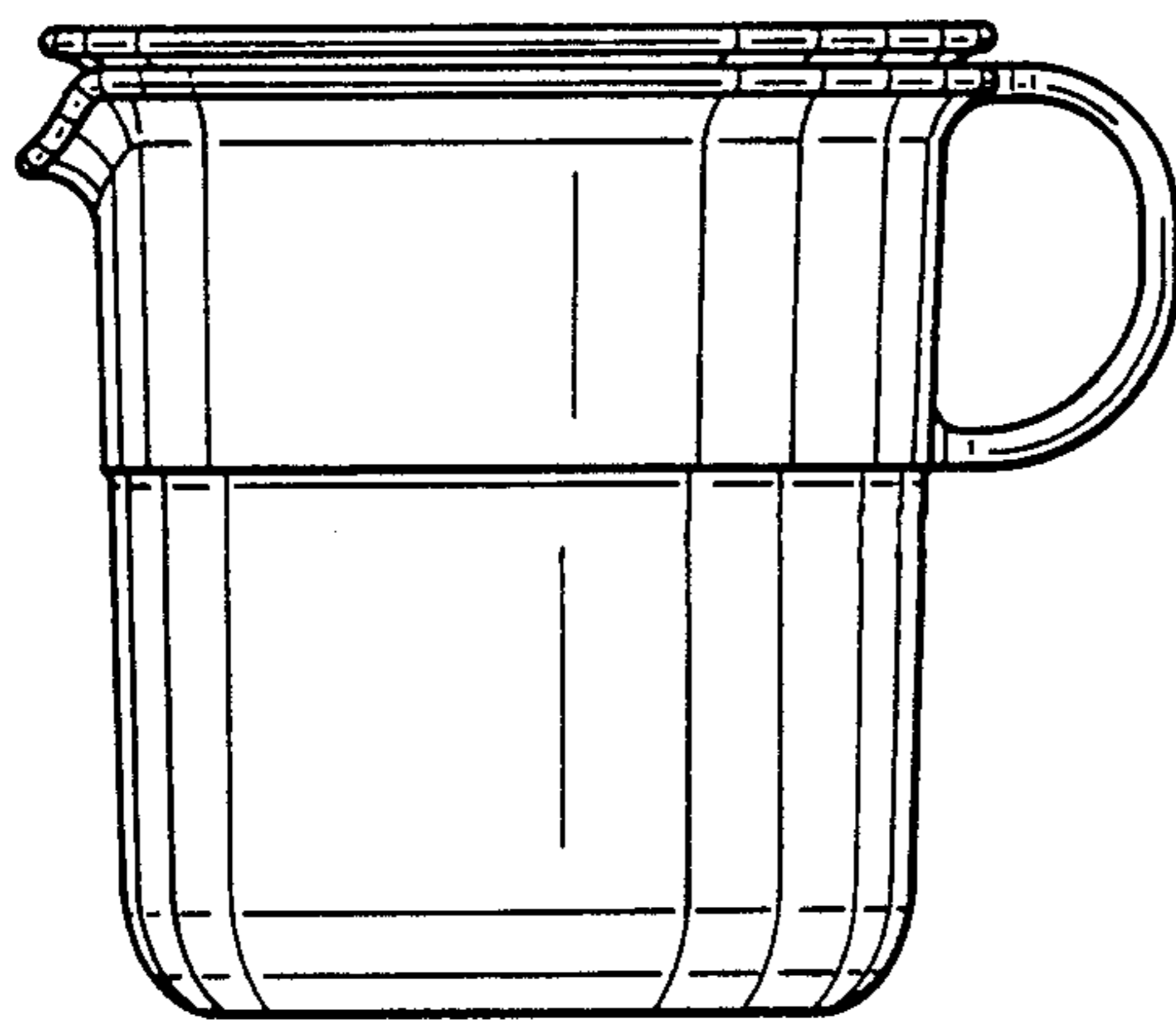

FIG. 11

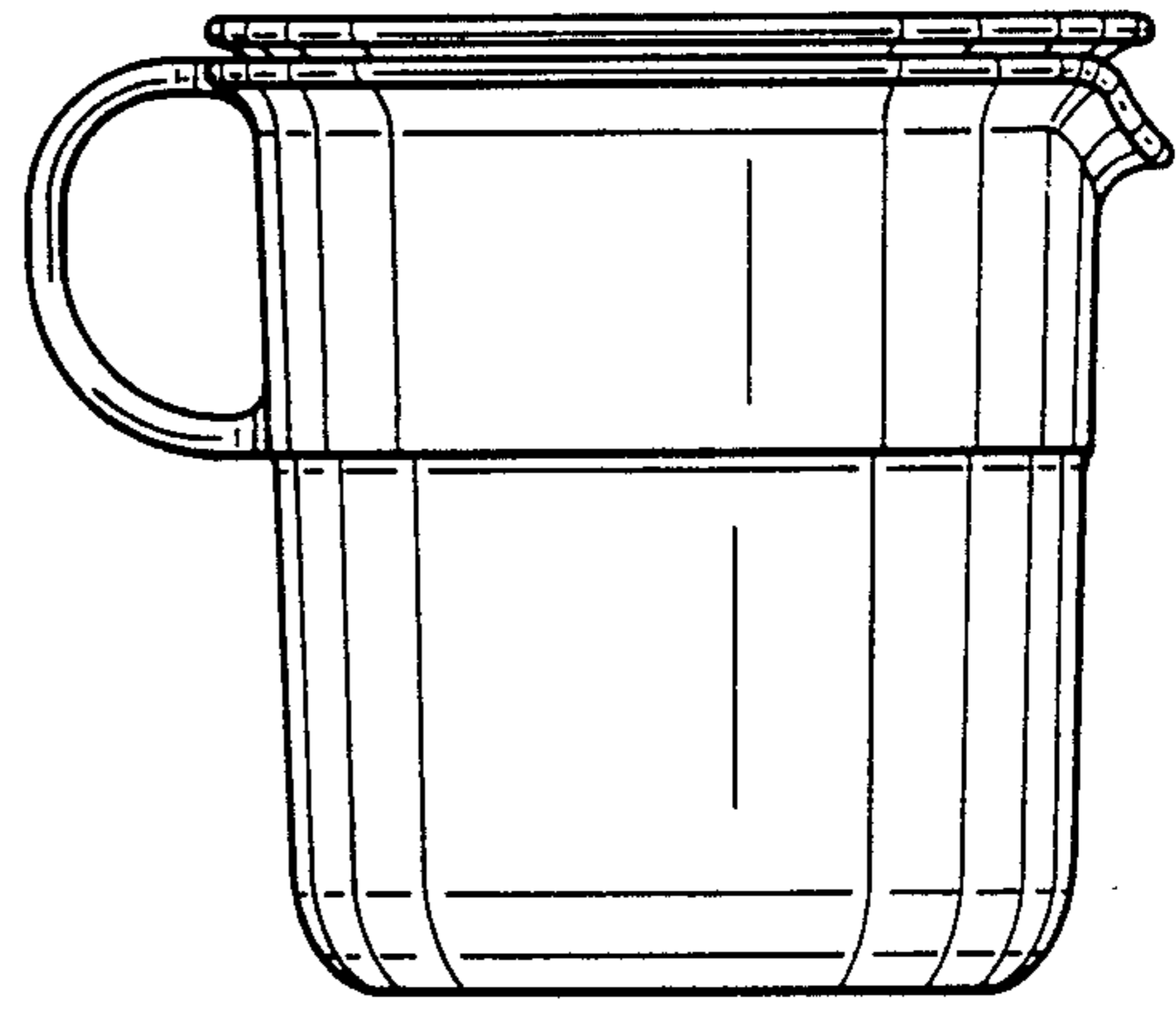

FIG. 12

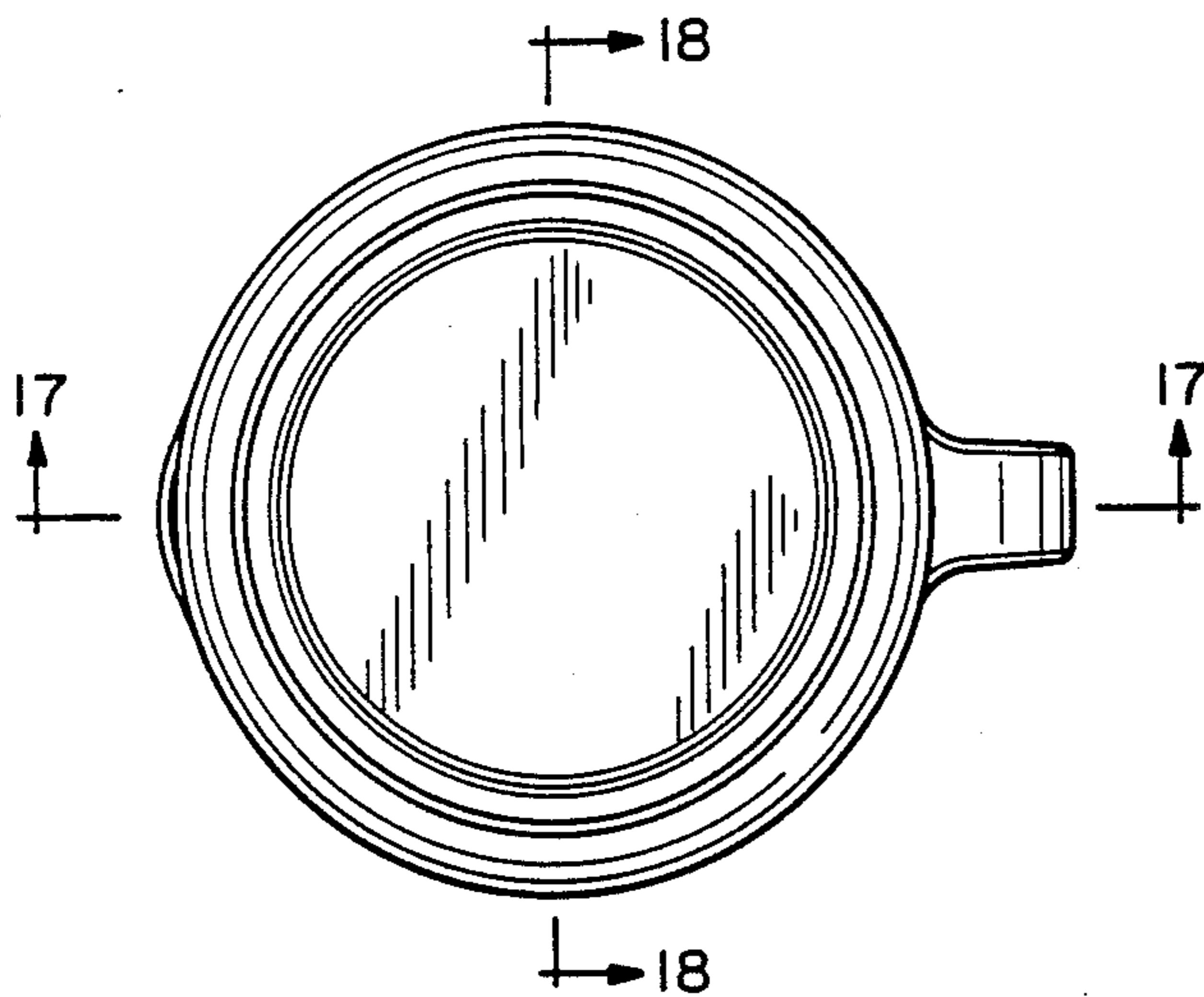

FIG. 13

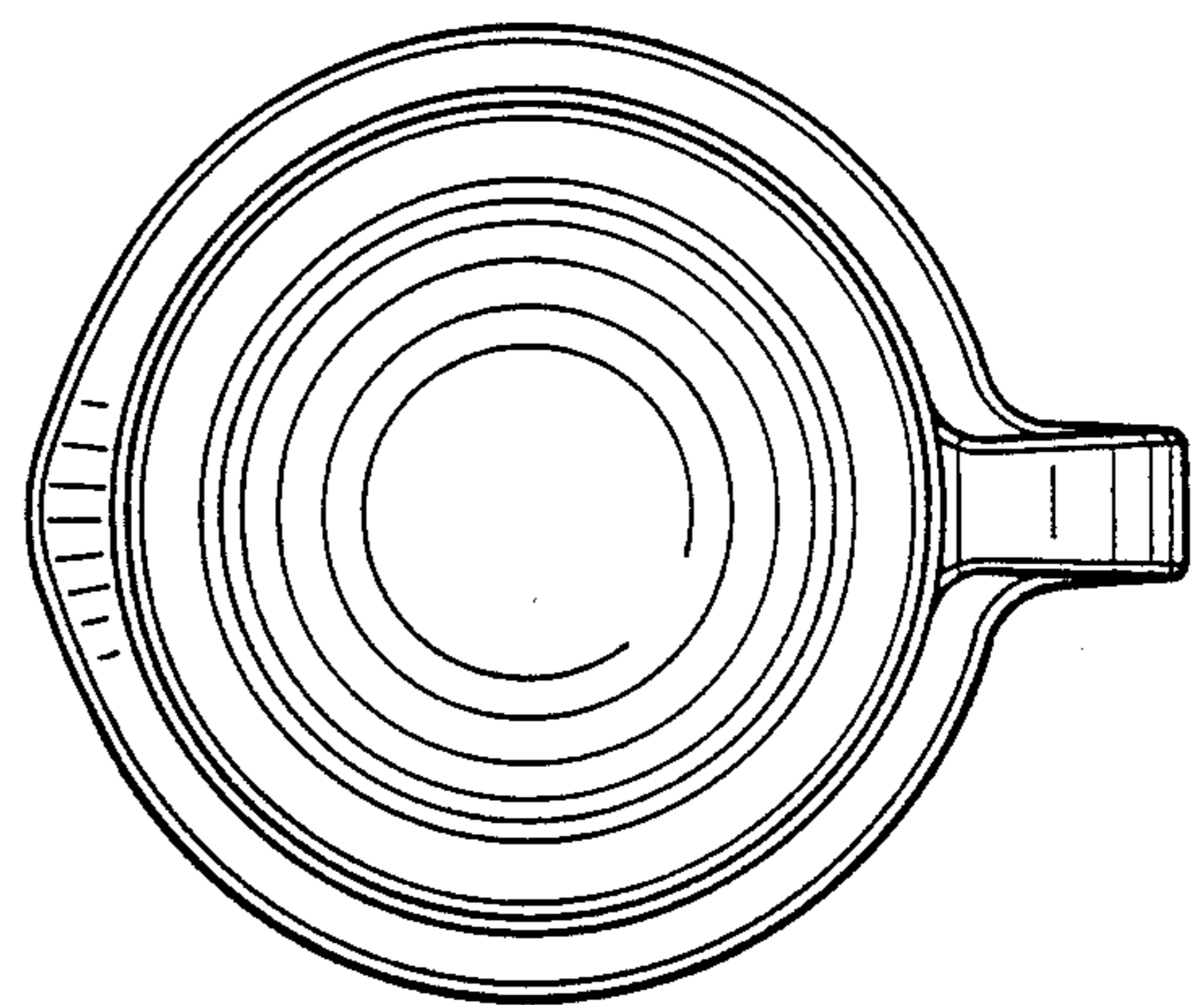

FIG. 14

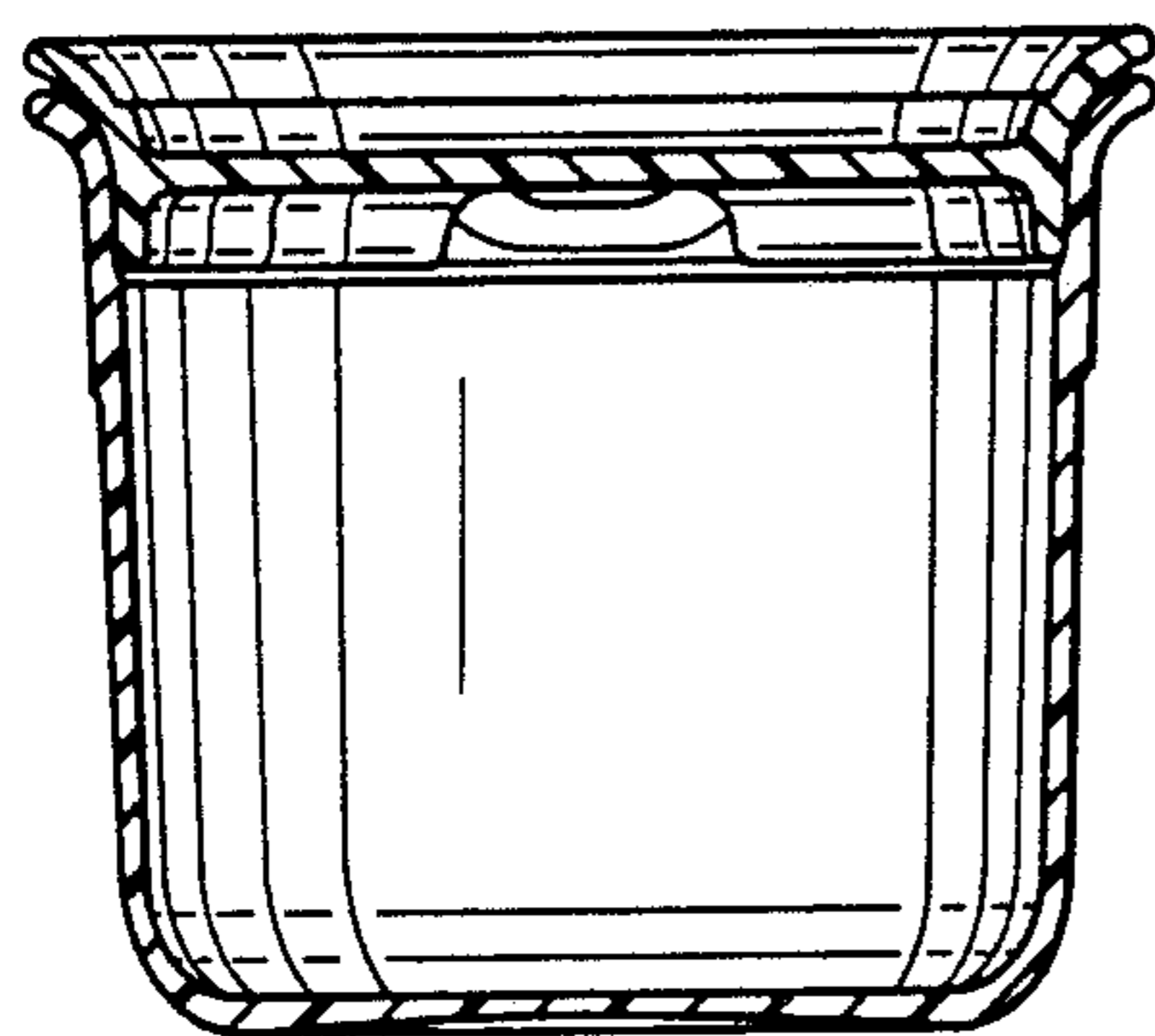

FIG. 15

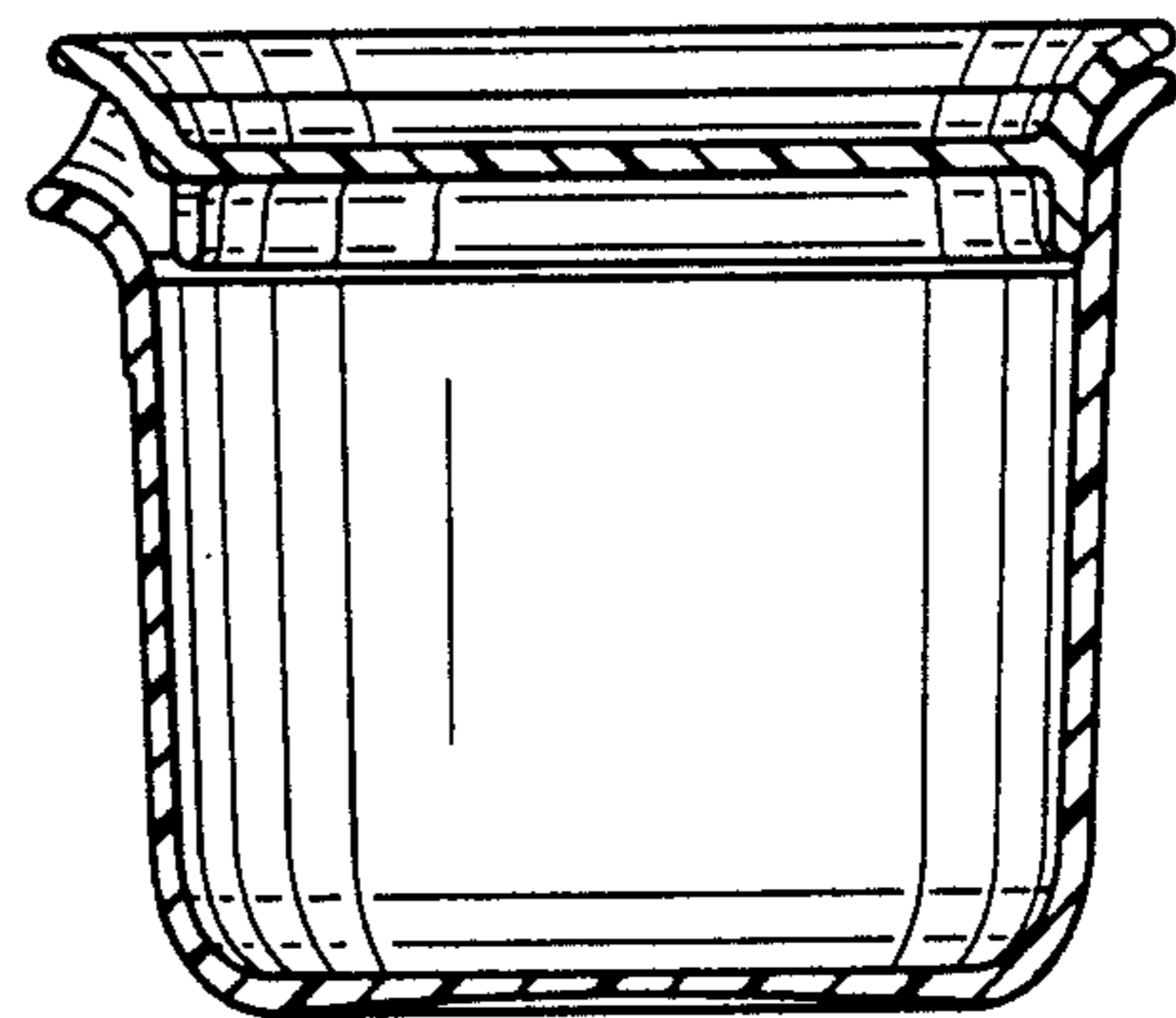

FIG. 16

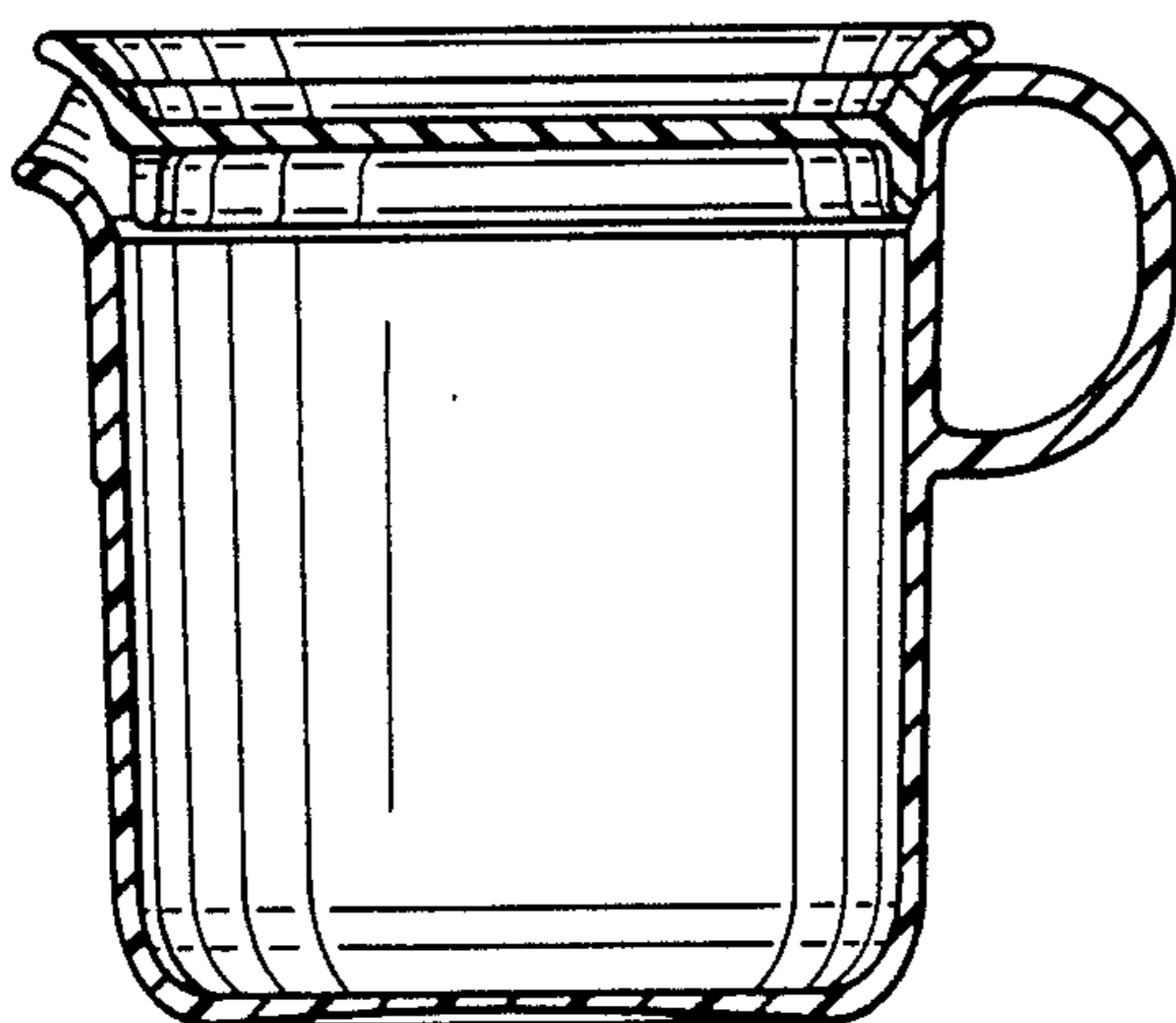

FIG. 17

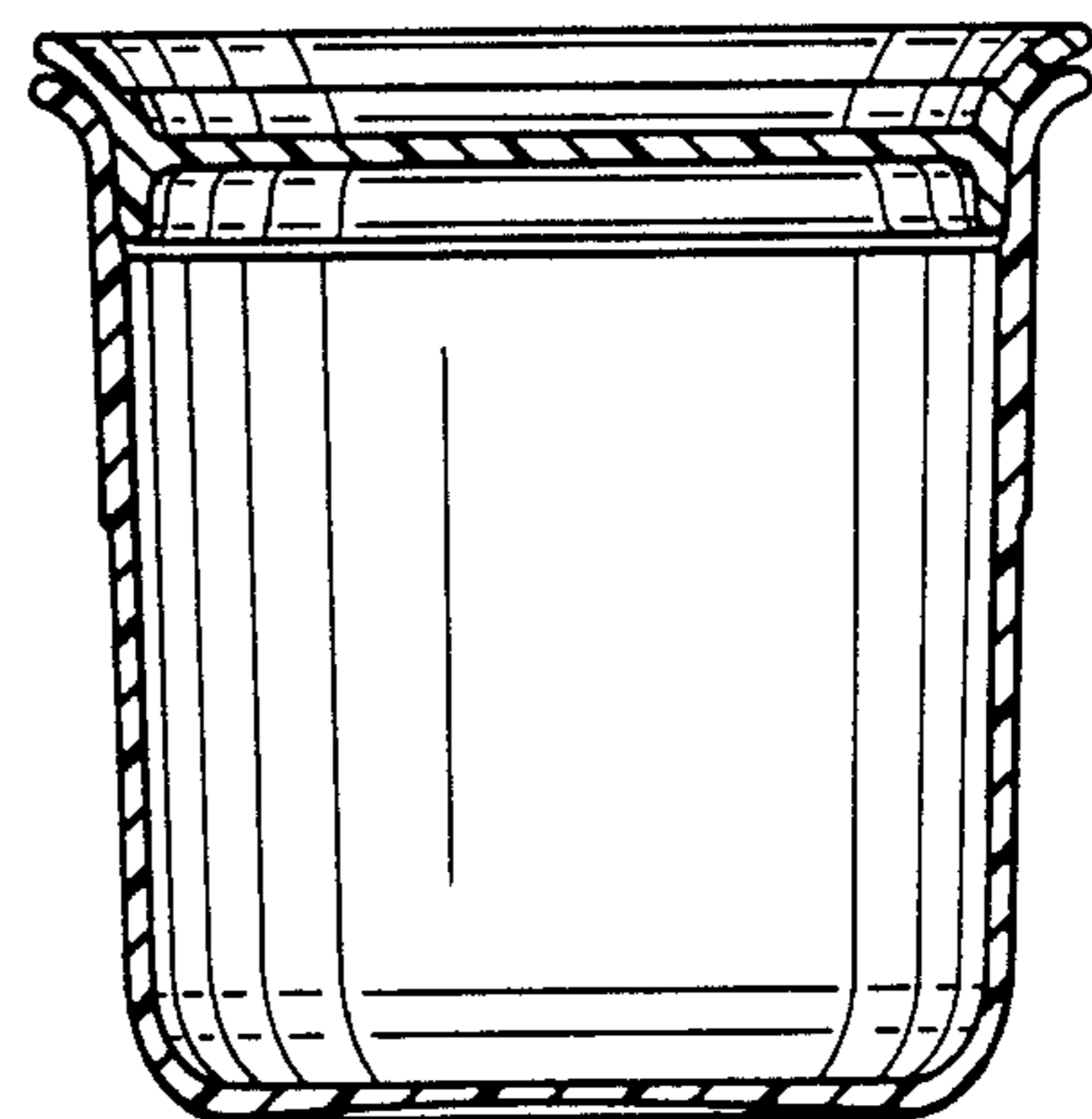

FIG. 18