

[54] TOY GUN

[76] Inventor: Donald R. Arnott, 5304 Sherbourne Dr., Nanaimo, British Columbia, Canada, V9T 2J8

[\*\*] Term: 14 Years

[21] Appl. No.: 239,841

[22] Filed: Sep. 2, 1988

[52] U.S. Cl. .... D21/147

[58] Field of Search ..... D21/145, 146, 147; D22/103, 104, 105; 446/15, 18, 20, 398, 401, 405

[56] References Cited

U.S. PATENT DOCUMENTS

D. 21,431	3/1892	Ives	.....	D21/146
D. 132,661	6/1942	Brubaker	.....	D21/147
202,742	4/1878	Mohr	.....	446/260
205,240	6/1878	Brunner	.....	446/405

D. 278,451	4/1985	Makhoulia	.....	D21/145
D. 295,545	5/1988	Bell	.....	D22/102
D. 297,345	8/1988	Hartfelder	.....	D22/104
1,868,312	7/1932	Coventry	.....	D21/147
3,022,779	2/1962	Benkoe	.....	D21/146

Primary Examiner—Charles A. Rademaker  
Assistant Examiner—Alicia A. Farrell  
Attorney, Agent, or Firm—Jerry T. Kearns

[57] CLAIM

The ornamental design for a toy gun, as shown and described.

DESCRIPTION

FIG. 1 is a front elevational view of a toy gun showing my new design;  
FIG. 2 is a rear elevational view thereof;  
FIG. 3 is a left side elevational view thereof;  
FIG. 4 is a right side elevational view thereof;  
FIG. 5 is a top plan view thereof; and,  
FIG. 6 is a bottom plan view thereof.

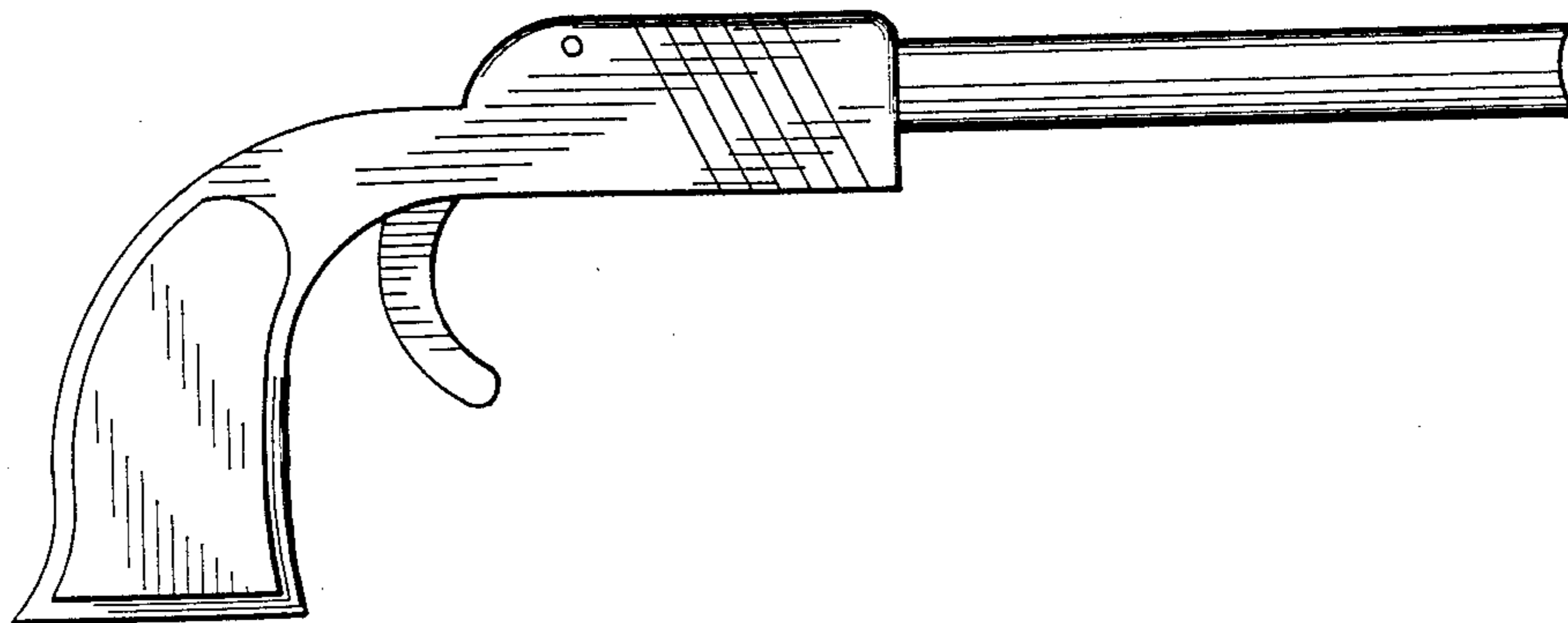

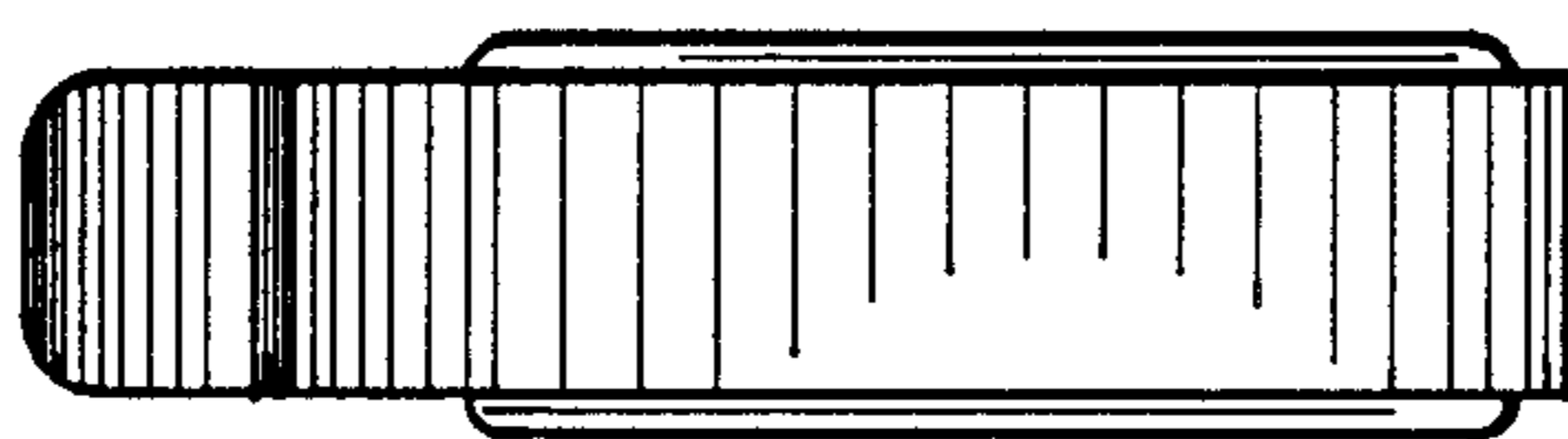

Fig. 2

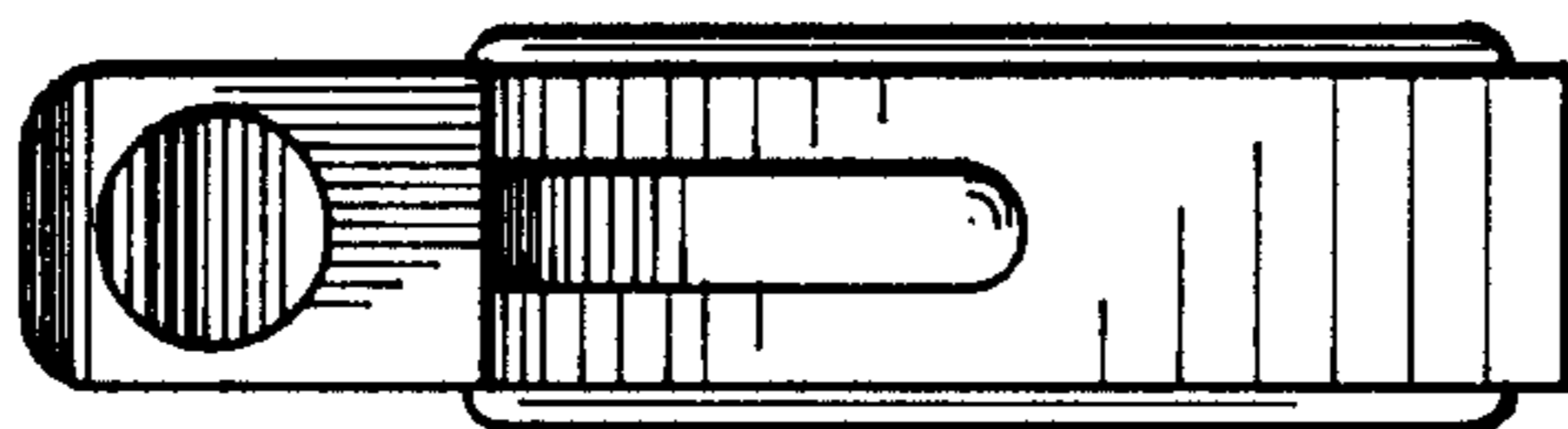

Fig. 1

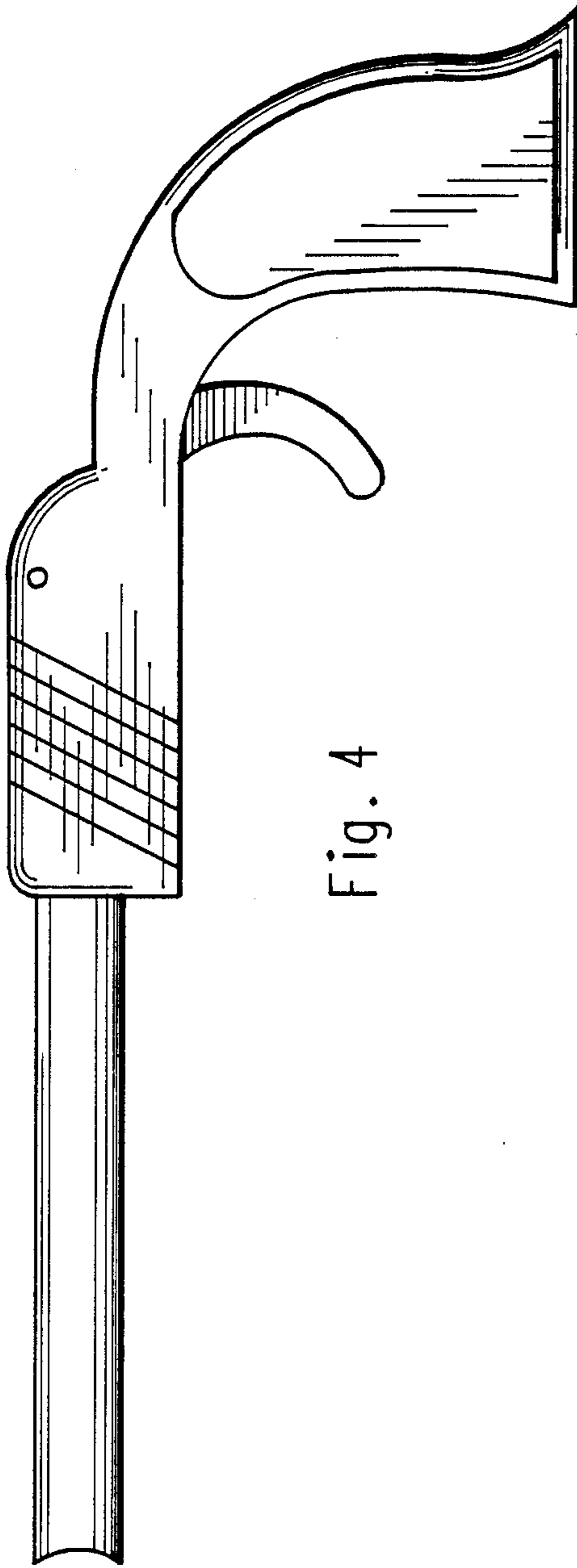

Fig. 4

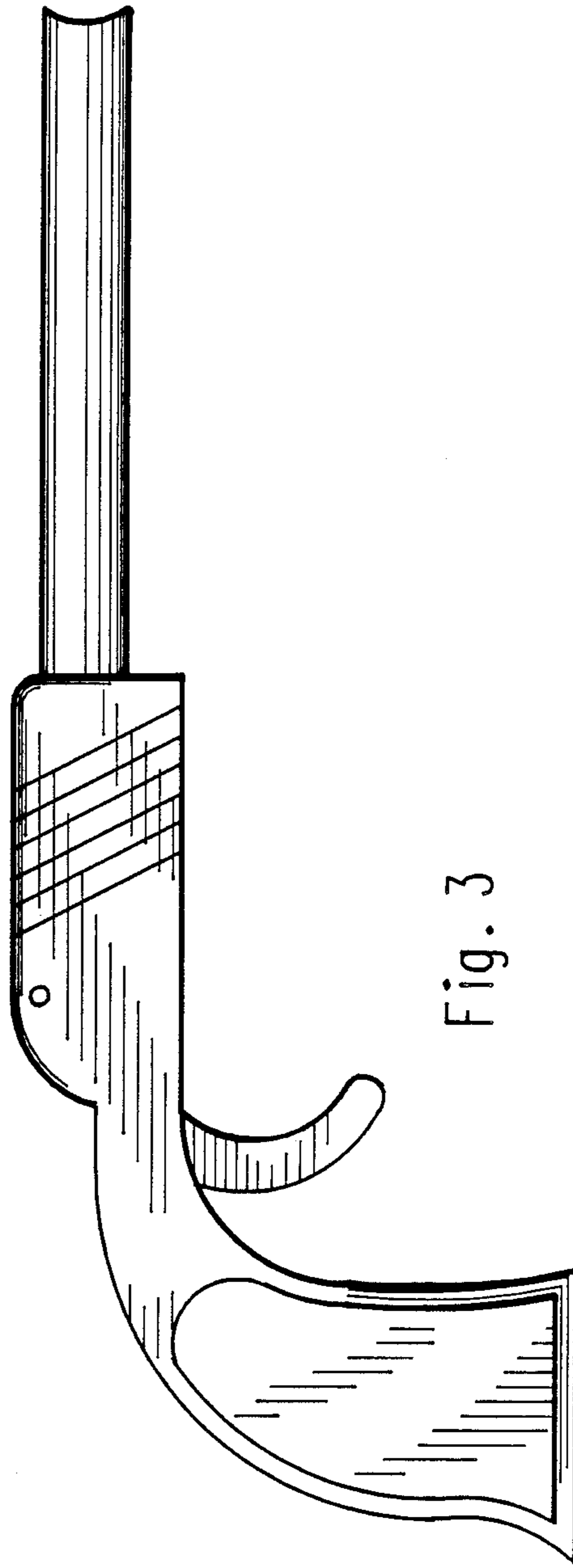

Fig. 3

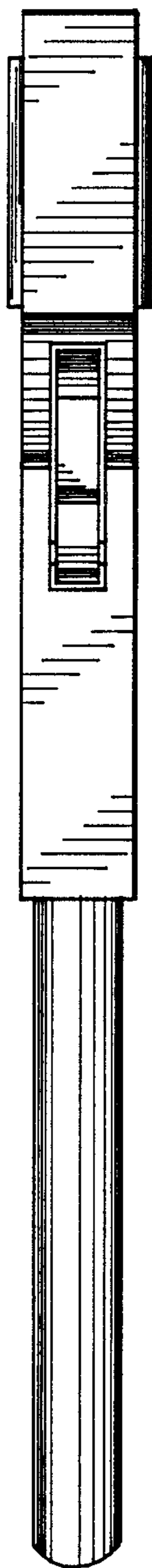

Fig. 6

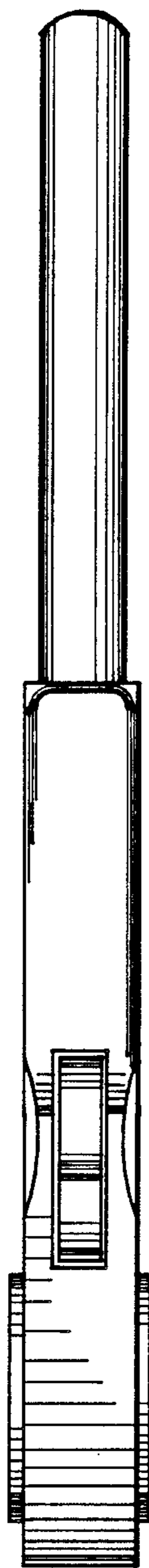

Fig. 5