

[54] BUSINESS CARD PUNCH

[76] Inventor: Lee R. Bowles, Jr., P.O. Box 372,  
Marble Falls, Tex. 78654

[\*\*] Term: 14 Years

[21] Appl. No.: 59,838

[22] Filed: Jun. 9, 1987

[52] U.S. Cl. .... D19/72; D19/65

[58] Field of Search ..... D19/72; 83/167, 467,  
83/560, 588, 618

[56] References Cited

U.S. PATENT DOCUMENTS

- D. 144,601 4/1946 Yerkes ..... D19/72
- D. 152,283 1/1949 Misson ..... D19/72
- D. 167,520 8/1952 Marano ..... D19/72
- D. 167,521 8/1952 Marano ..... D19/72

- D. 251,600 4/1979 MacGregor ..... D19/72
- D. 289,776 5/1989 Goertz et al. .... D19/72

Primary Examiner—Bruce W. Dunkins  
Assistant Examiner—Martha Thompson  
Attorney, Agent, or Firm—John C. Stahl

[57] CLAIM

The ornamental design for a business card punch, as shown.

DESCRIPTION

FIG. 1 is a side elevational view of a business card punch, showing my new design.  
FIG. 2 is a front elevational view;  
FIG. 3 is a top plan view;  
FIG. 4 is a rear elevational view;  
FIG. 5 is a bottom plan view; and  
FIG. 6 is a perspective view thereof.

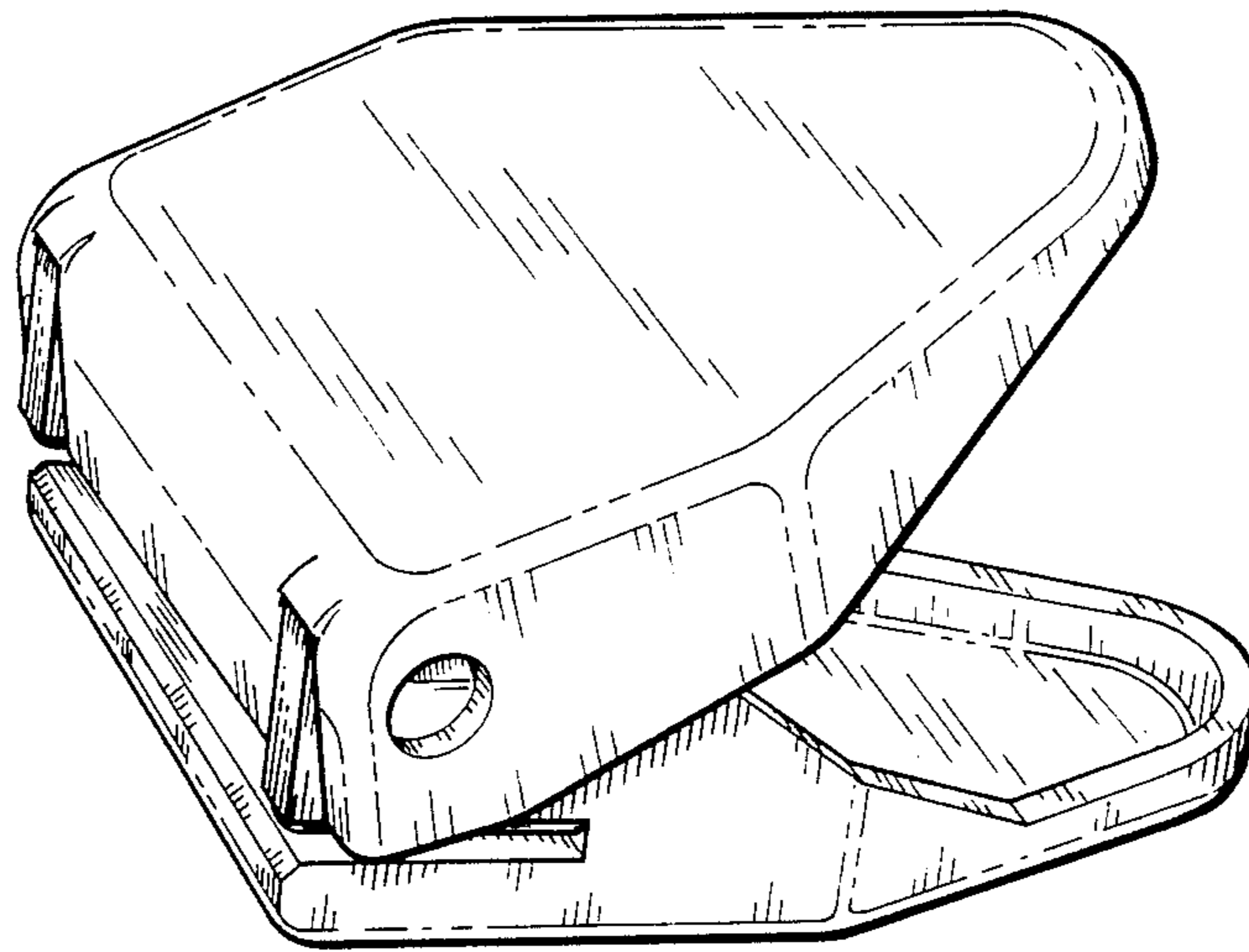

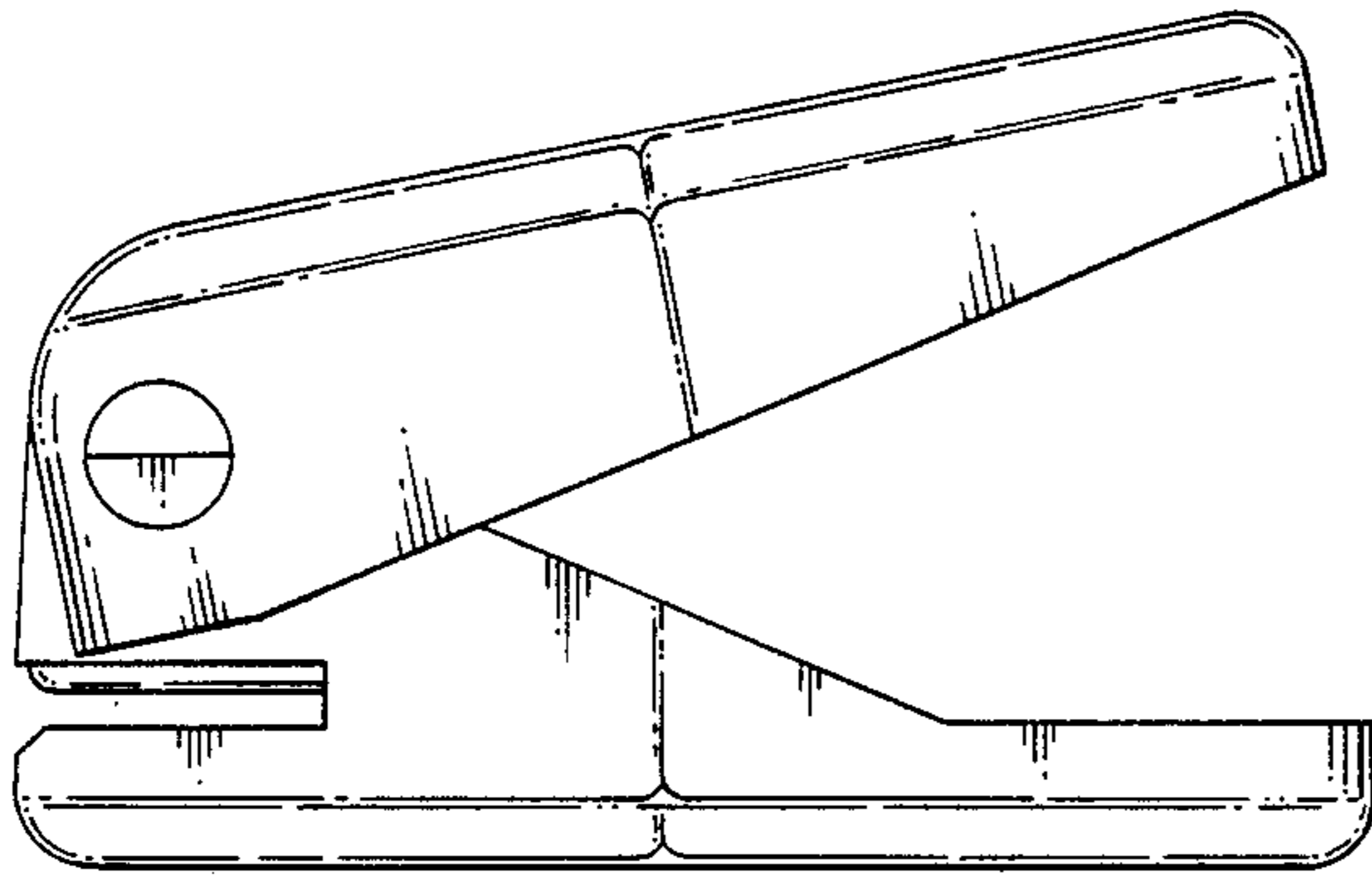

FIG. 1

FIG. 2

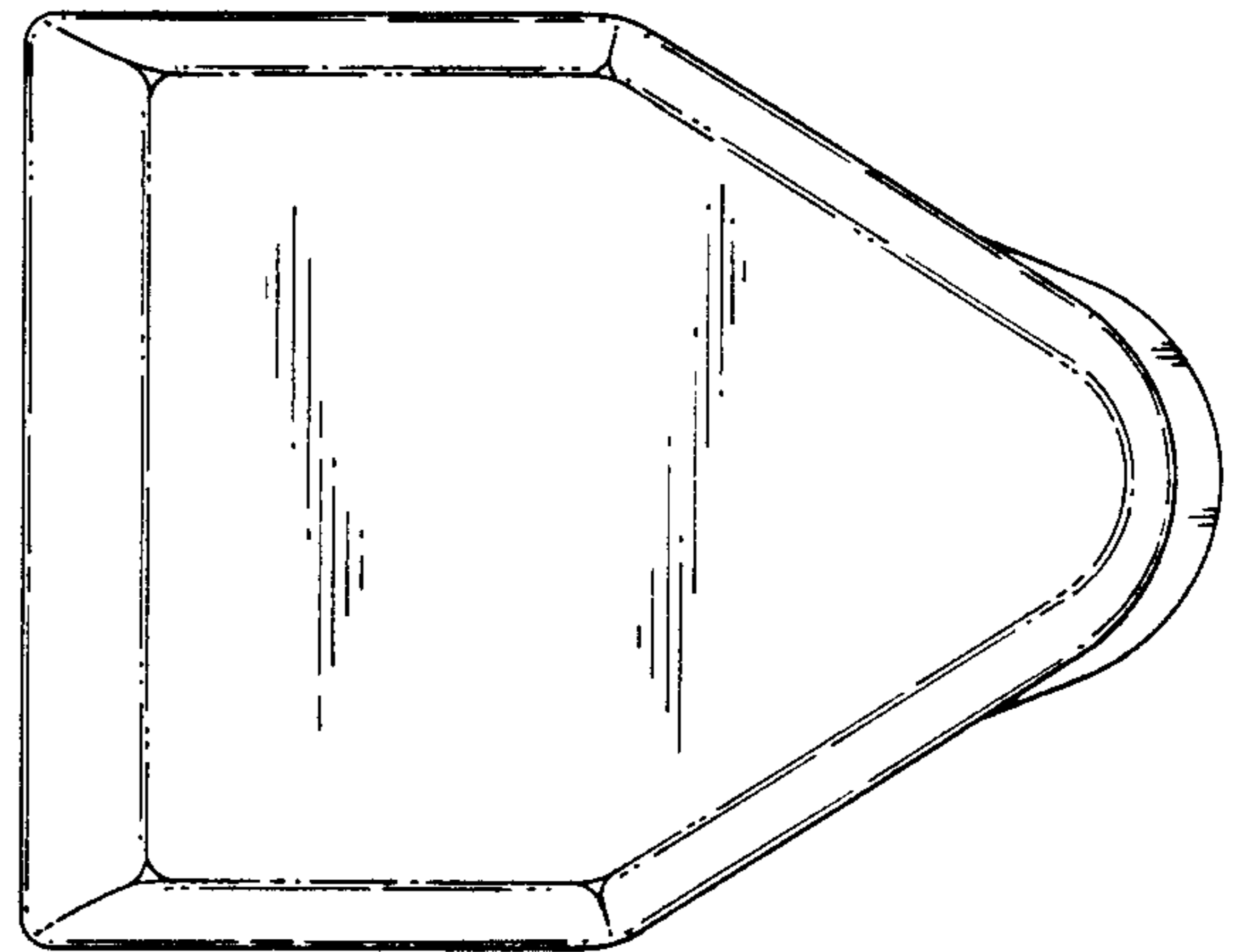
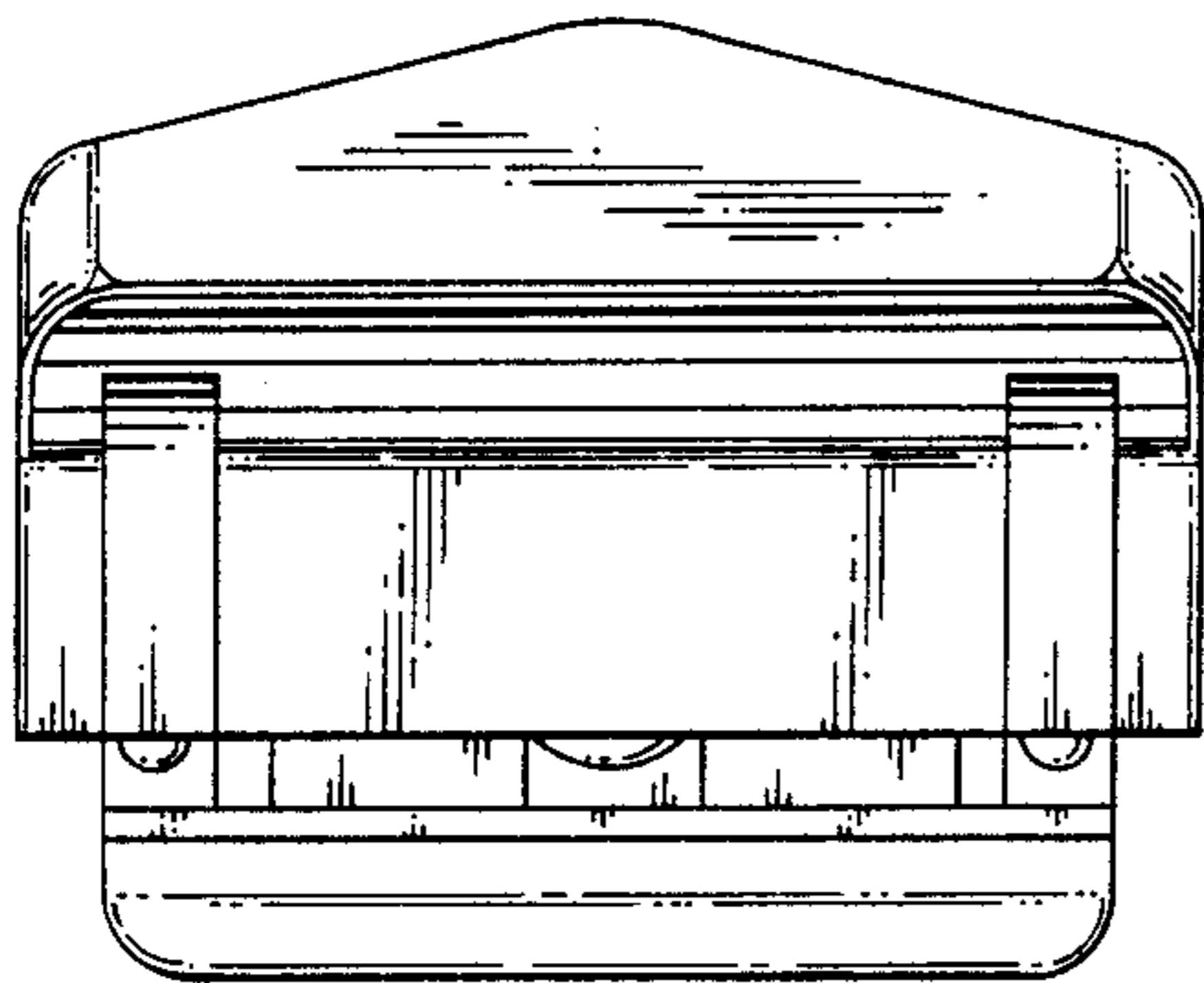

FIG. 3

FIG. 4

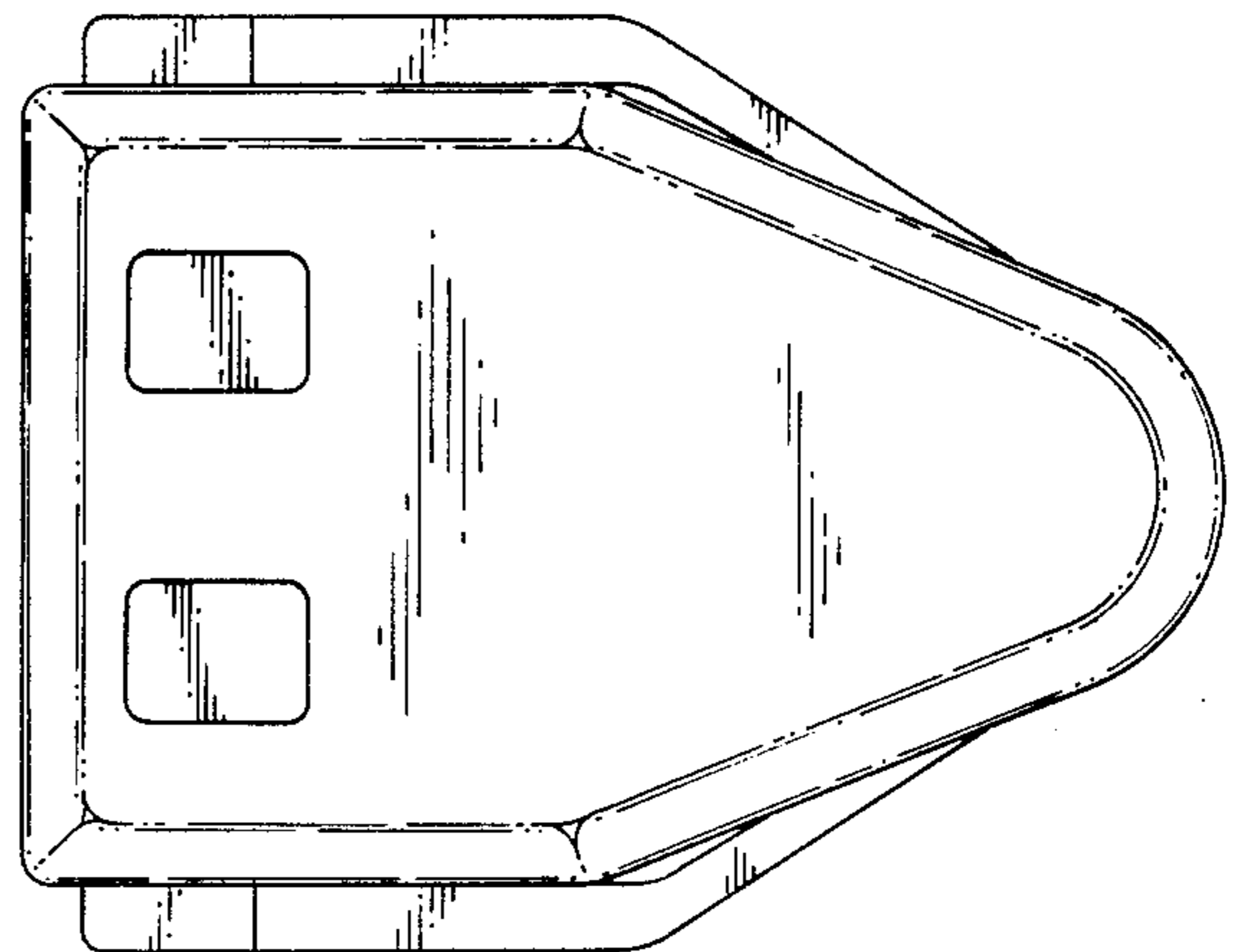
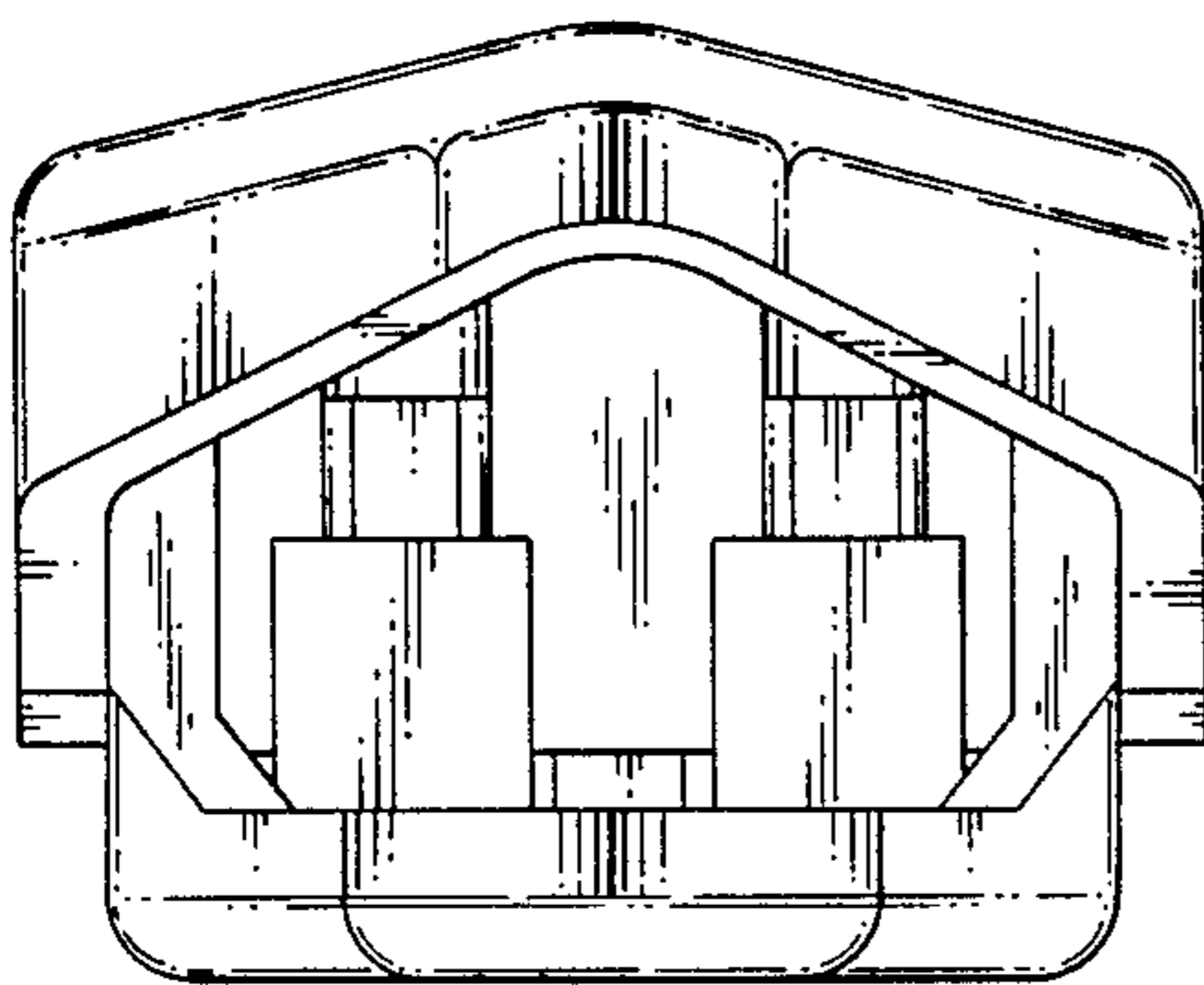
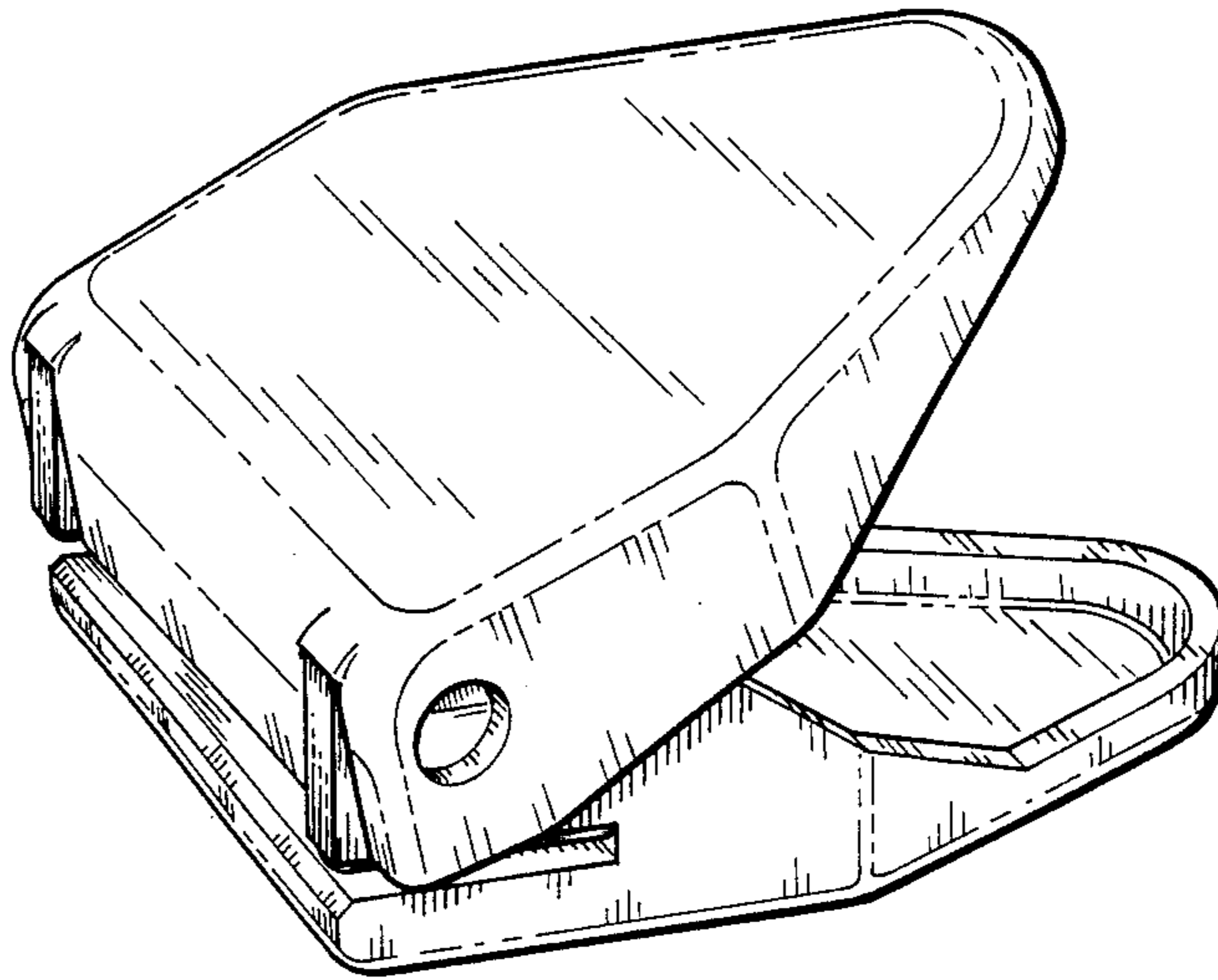

FIG. 5



*FIG. 6*