

[54] ICE HOLDER

2,473,411 6/1949 Boden D7/667 X

[76] Inventor: Frank E. Williamson, 5014 Valley Lake Rd., Austell, Ga. 30001

Primary Examiner—Bernard Ansher
Assistant Examiner—Terry A. Pfeffer
Attorney, Agent, or Firm—Jerry T. Kearns

[**] Term: 14 Years

[57] CLAIM

[21] Appl. No.: 195,190

The ornamental design for an ice holder, as shown and described.

[22] Filed: May 18, 1988

[52] U.S. Cl. D7/667

[58] Field of Search D7/667, 396.2, 396.3; 210/469, 474, 477.8; 215/101; 220/90.4, 90.6

DESCRIPTION

FIG. 1 is a front elevational view of an ice holder showing my new design;
FIG. 2 is a rear elevational view thereof;
FIG. 3 is a left side elevational view thereof;
FIG. 4 is a right side elevational view thereof;
FIG. 5 is a top plan view thereof; and,
FIG. 6 is a bottom plan view thereof.

[56] References Cited

U.S. PATENT DOCUMENTS

1,293,297 2/1919 Anderson D7/667
2,106,453 1/1938 Ekdahl D7/667 X

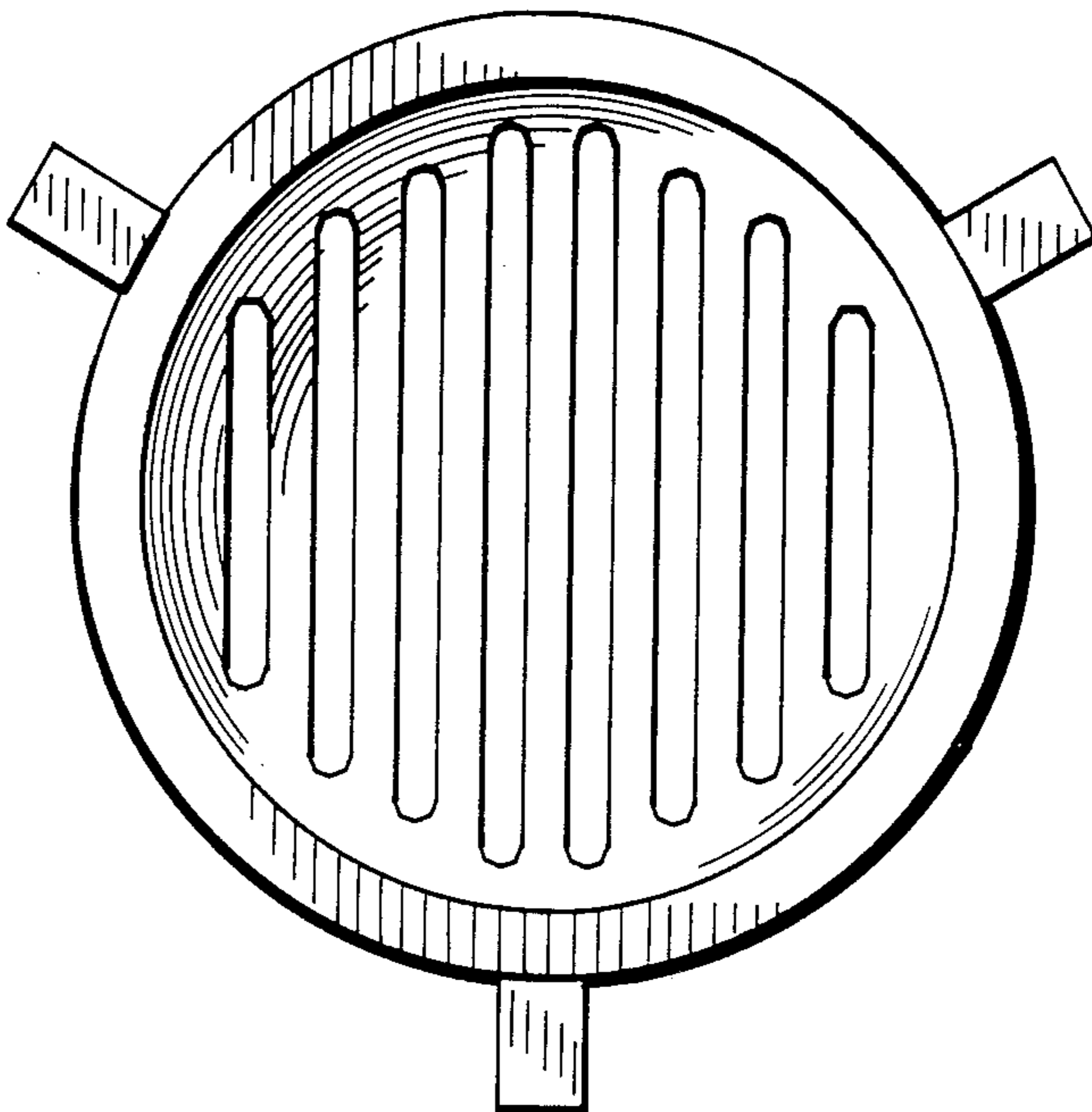
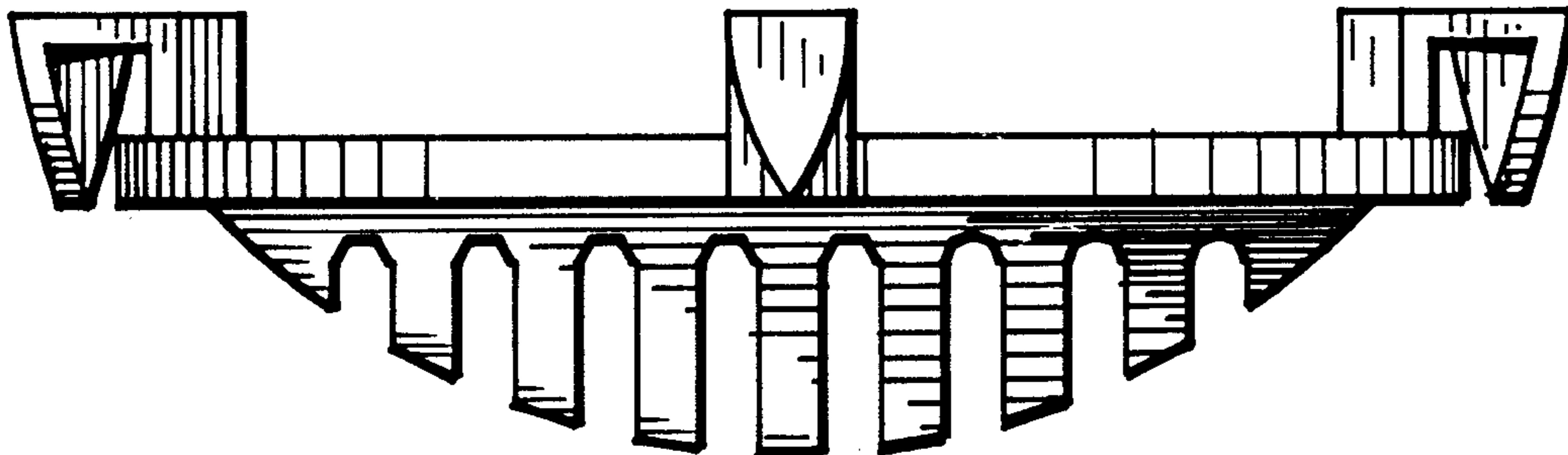

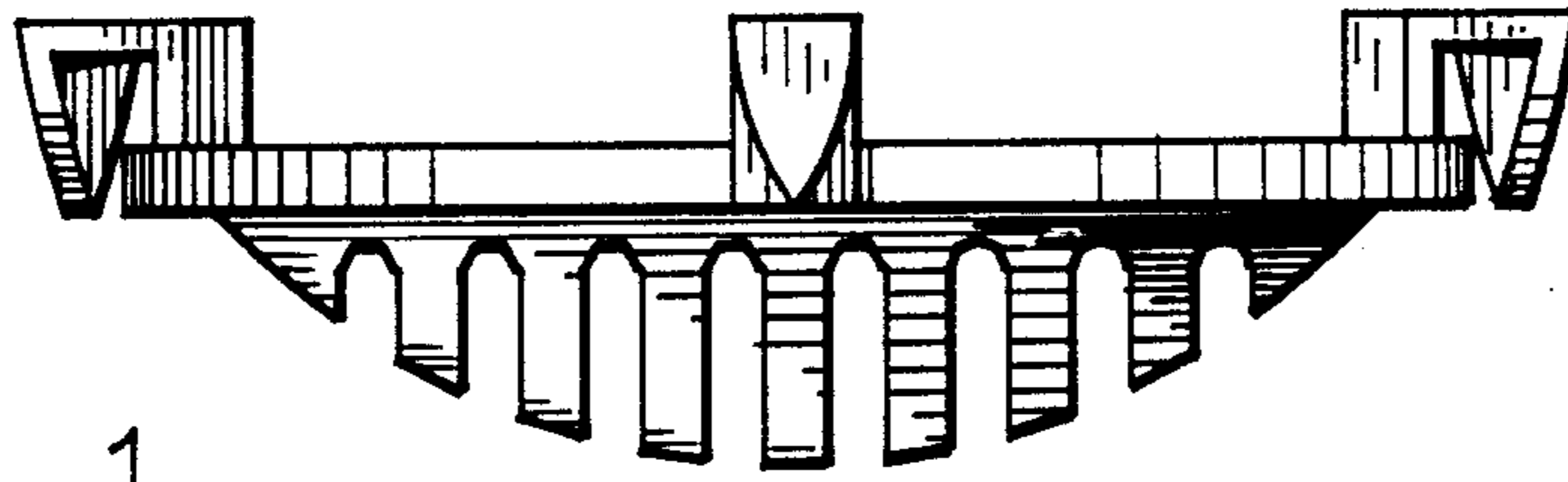

Fig. 1

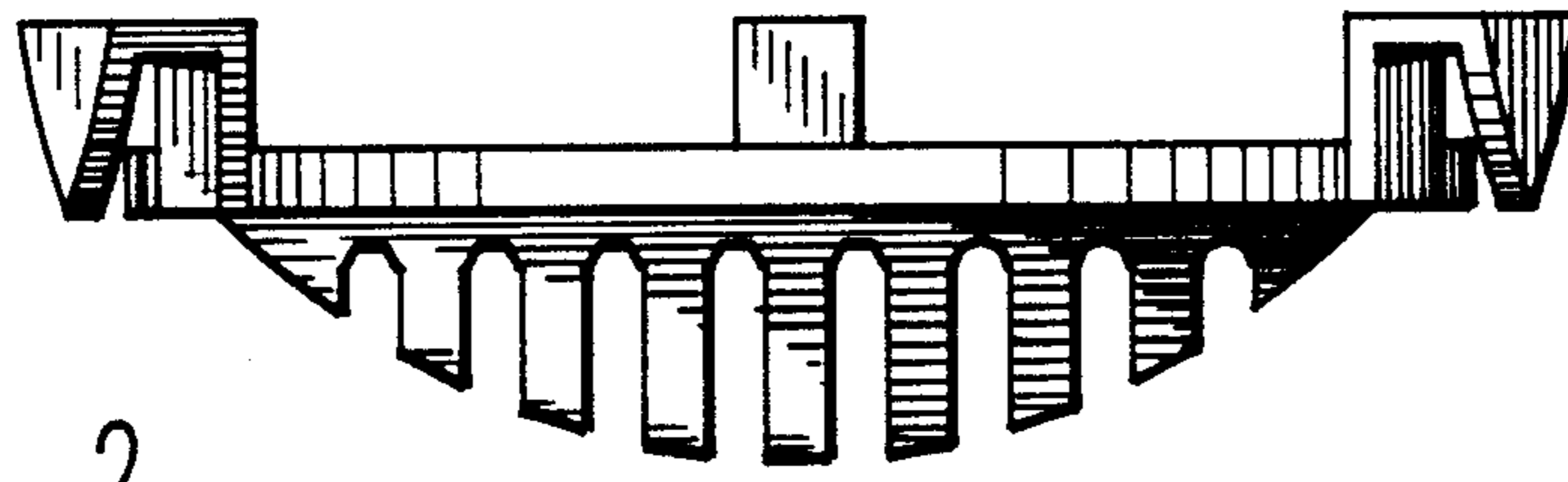

Fig. 2

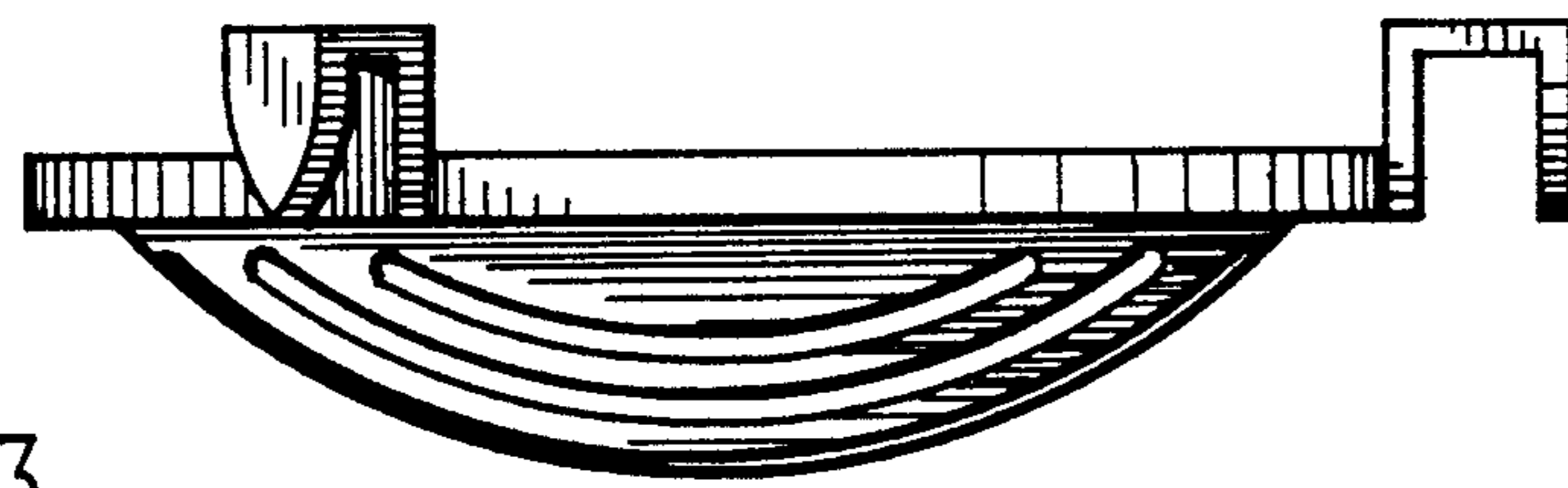

Fig. 3

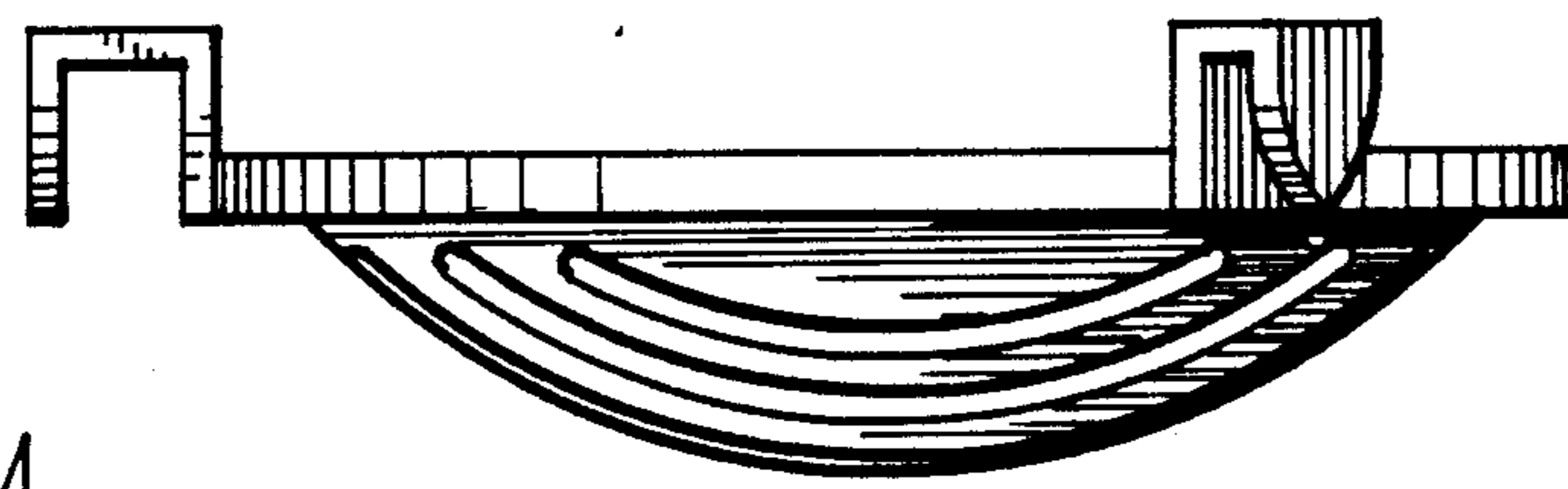

Fig. 4

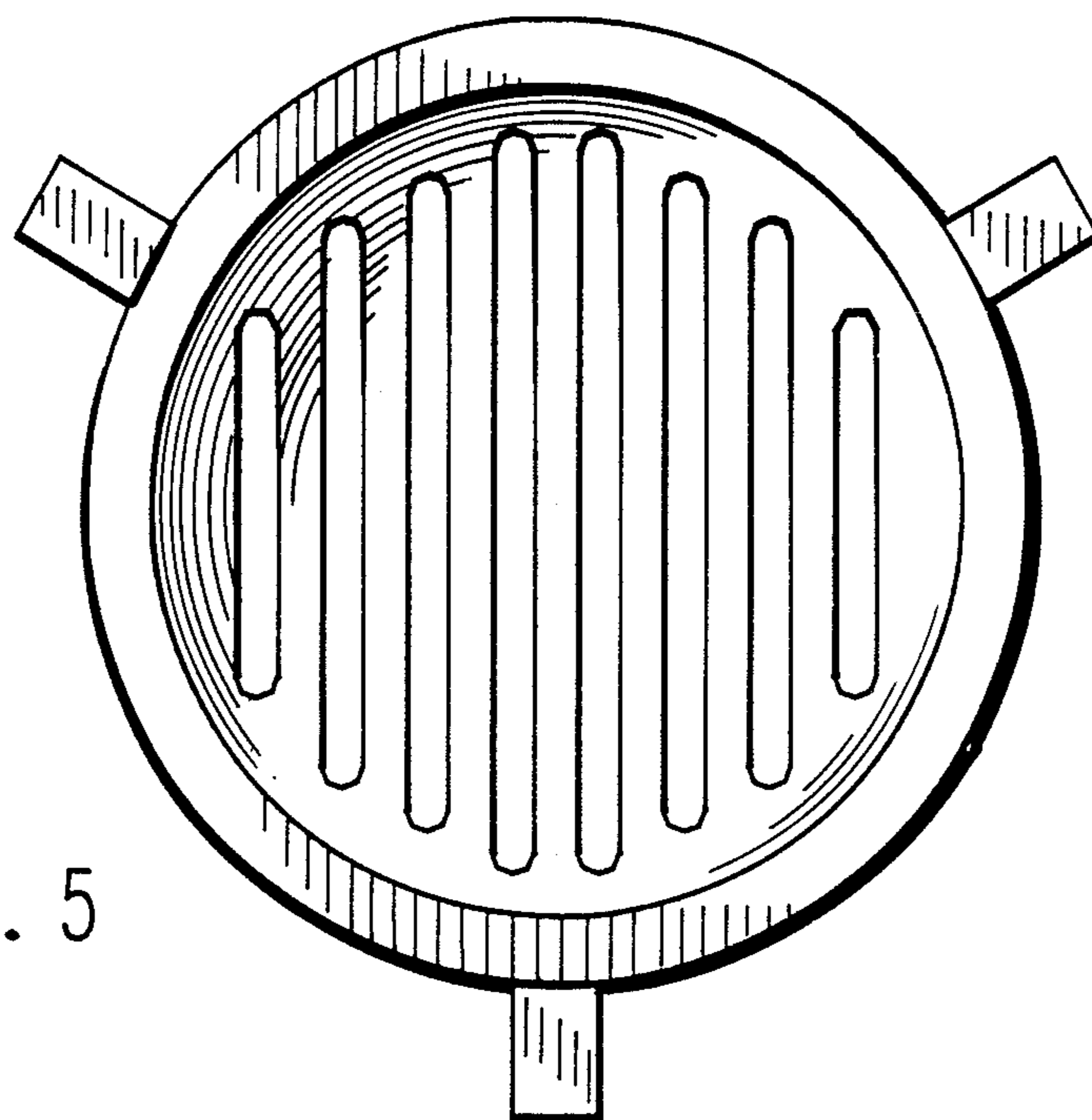

Fig. 5

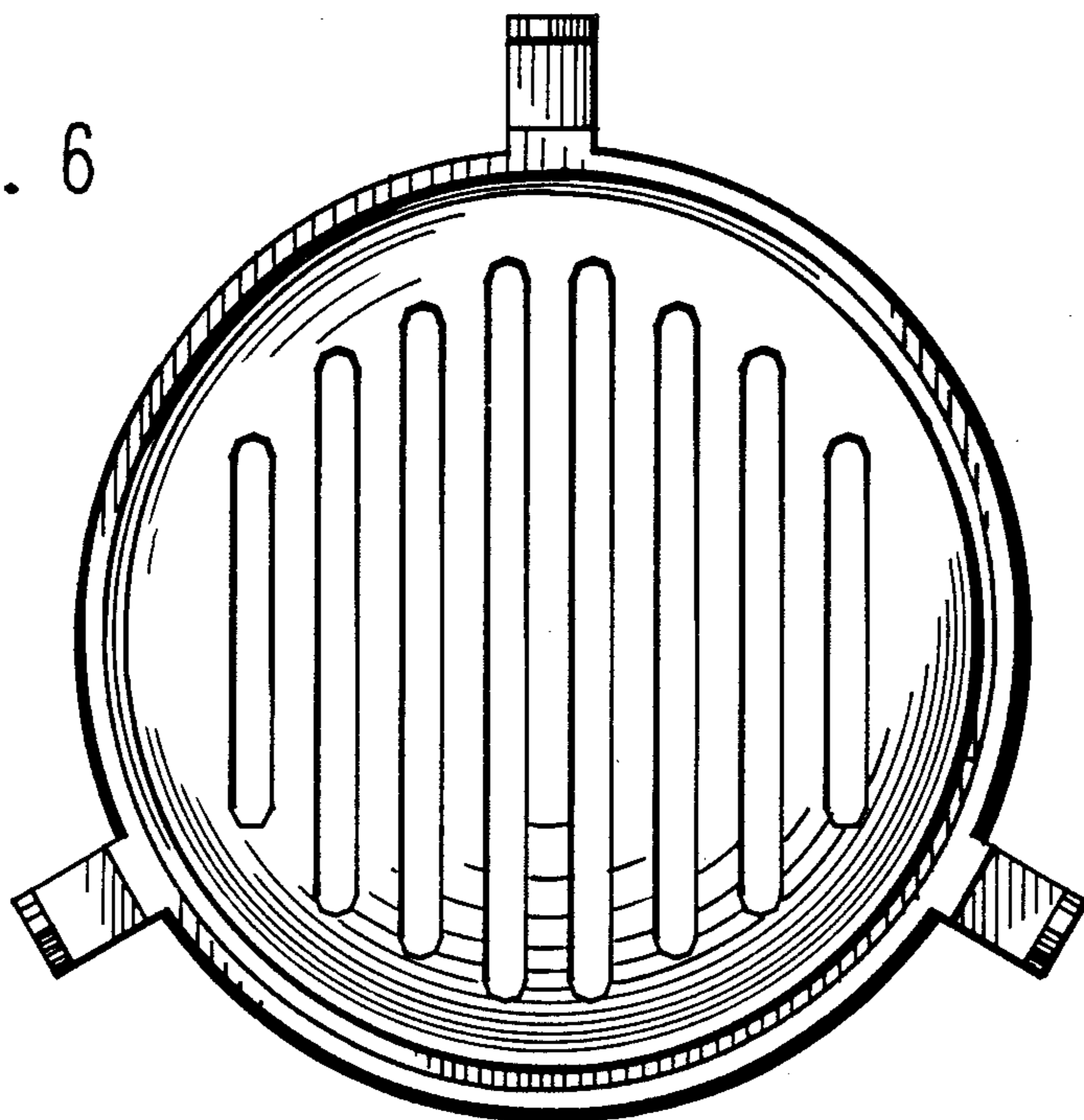

Fig. 6