

[54] BUCKET HOLDER

[75] Inventor: Roland Poivre, Ste-Foy, Canada

[73] Assignee: Cannabec Sales Representatives LTD, Richmond, Canada

[**] Term: 14 Years

[21] Appl. No.: 111,162

[22] Filed: Oct. 22, 1987

[30] Foreign Application Priority Data

Jun. 12, 1987 [CA] Canada 12-06-87-1

[52] U.S. Cl. D8/373; D6/567; D6/403; 248/300

[58] Field of Search D8/370; D6/567, 572, D6/571; 248/214, 300, 65, 403

[56] References Cited

U.S. PATENT DOCUMENTS

D. 24,174	4/1895	Liebauser	D6/567
D. 30,609	4/1899	Murphy	D8/370
D. 96,418	7/1935	Scott et al.	D6/403
163 531	5/1875	Ruake	248/65

D. 175,455	8/1955	Bartleman	D6/572
D. 277,055	1/1985	Bachanan	D8/370
D. 286,009	10/1986	Nadav	D6/567
754,285	3/1904	Dick	248/214
2,628,054	2/1953	Fazakenley	248/300

OTHER PUBLICATIONS

Architectural Graphic Standards ©1981: at p. 516; Perforated Board Fixtures: 10 Storage Shelving.

Primary Examiner—Horace B. Fay, Jr.

Attorney, Agent, or Firm—Charles E. Brown; Charles A. Brown

[57] CLAIM

The ornamental design for a bucket holder, as shown and described.

DESCRIPTION

FIG. 1 is a front and right side perspective view of a bucket holder showing my new design;

FIG. 2 is a top plan view thereof;

FIG. 3 is a left side elevational view thereof;

FIGS. 4 and 5 are respectively front and rear elevational views thereof; and

FIG. 6 is a bottom plan view thereof.

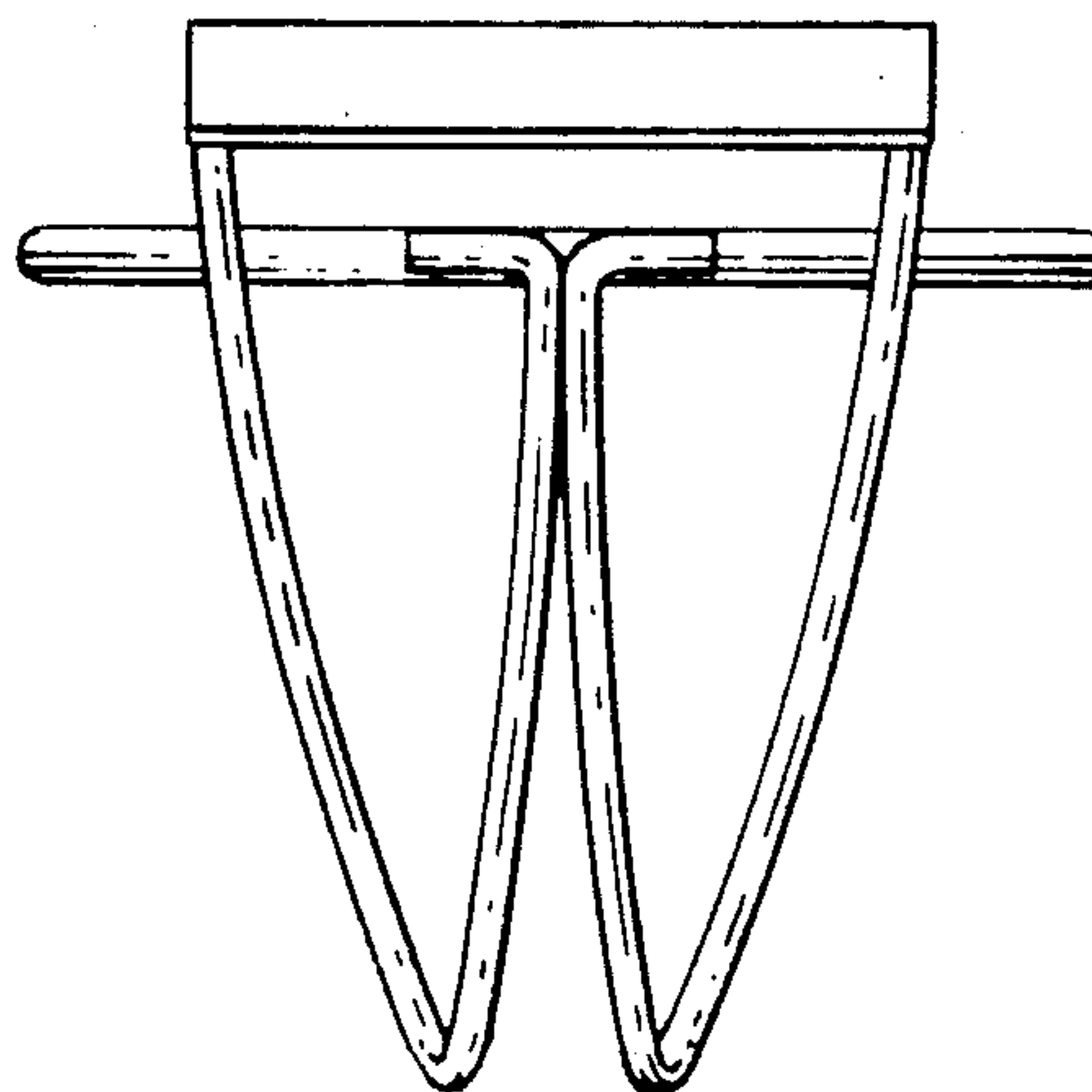
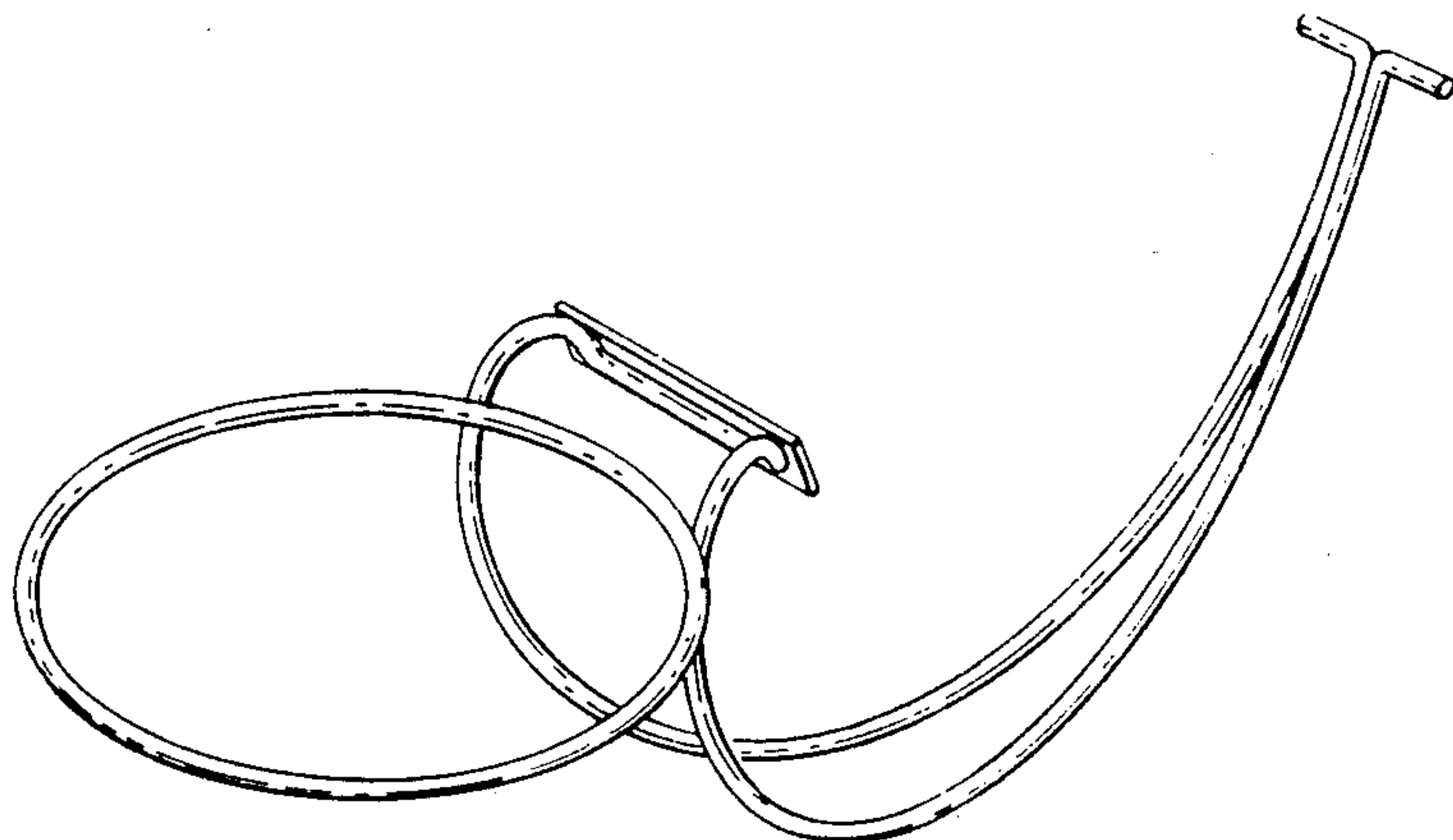

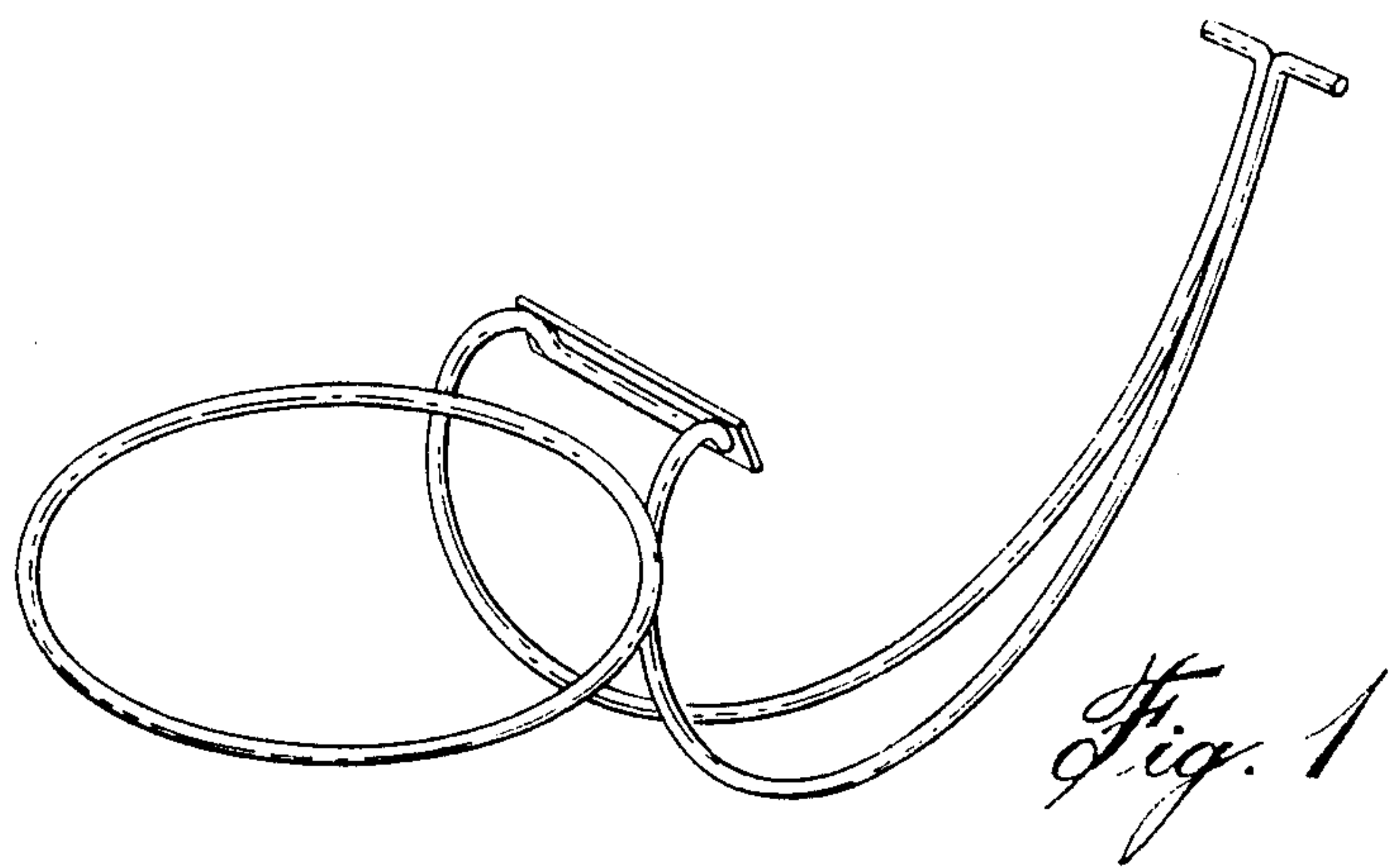

Fig. 1

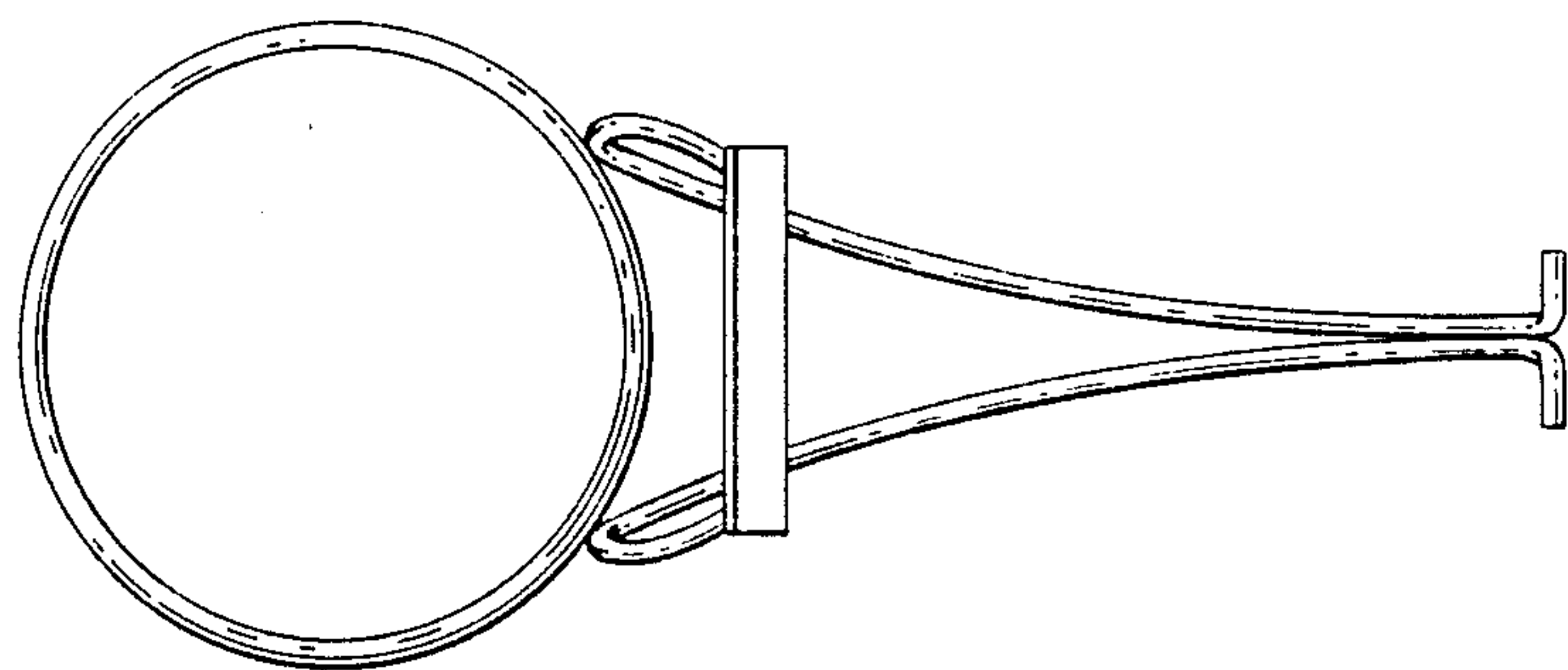

Fig. 2

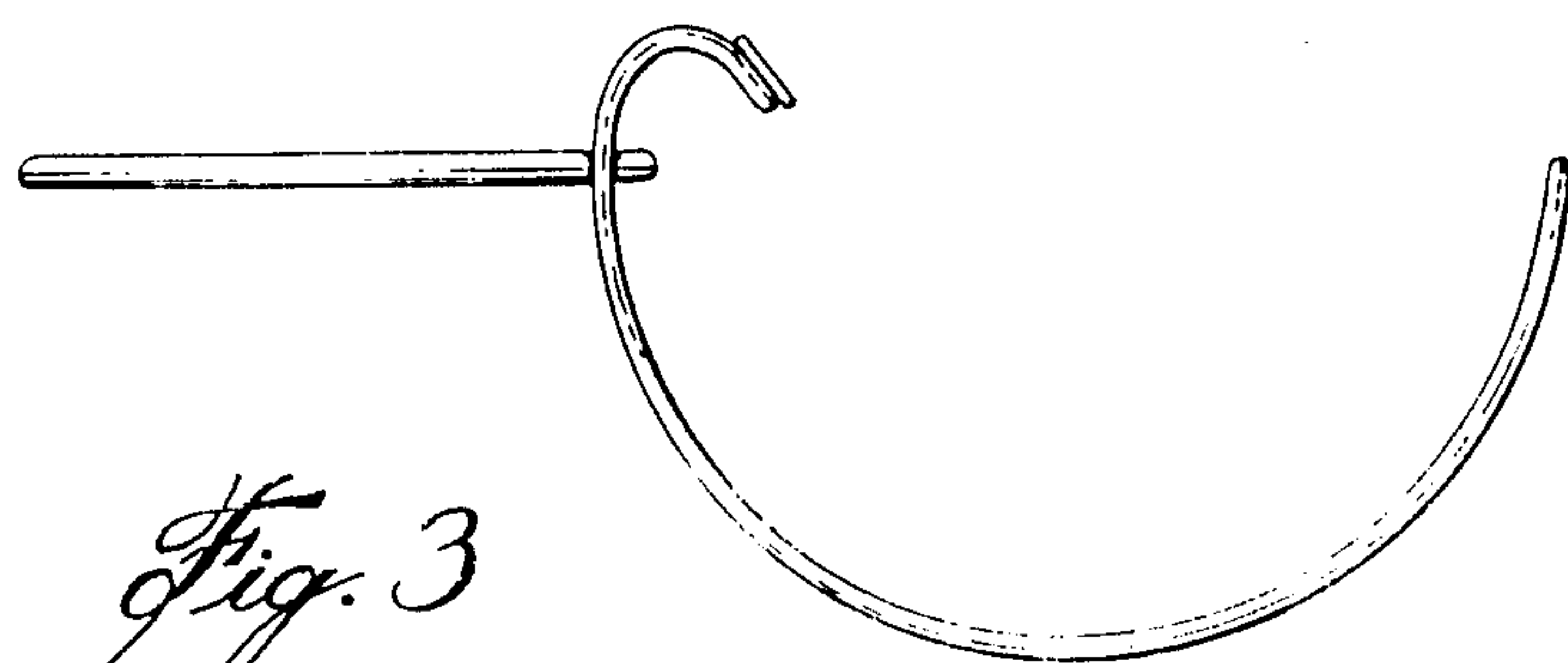

Fig. 3

Fig. 4

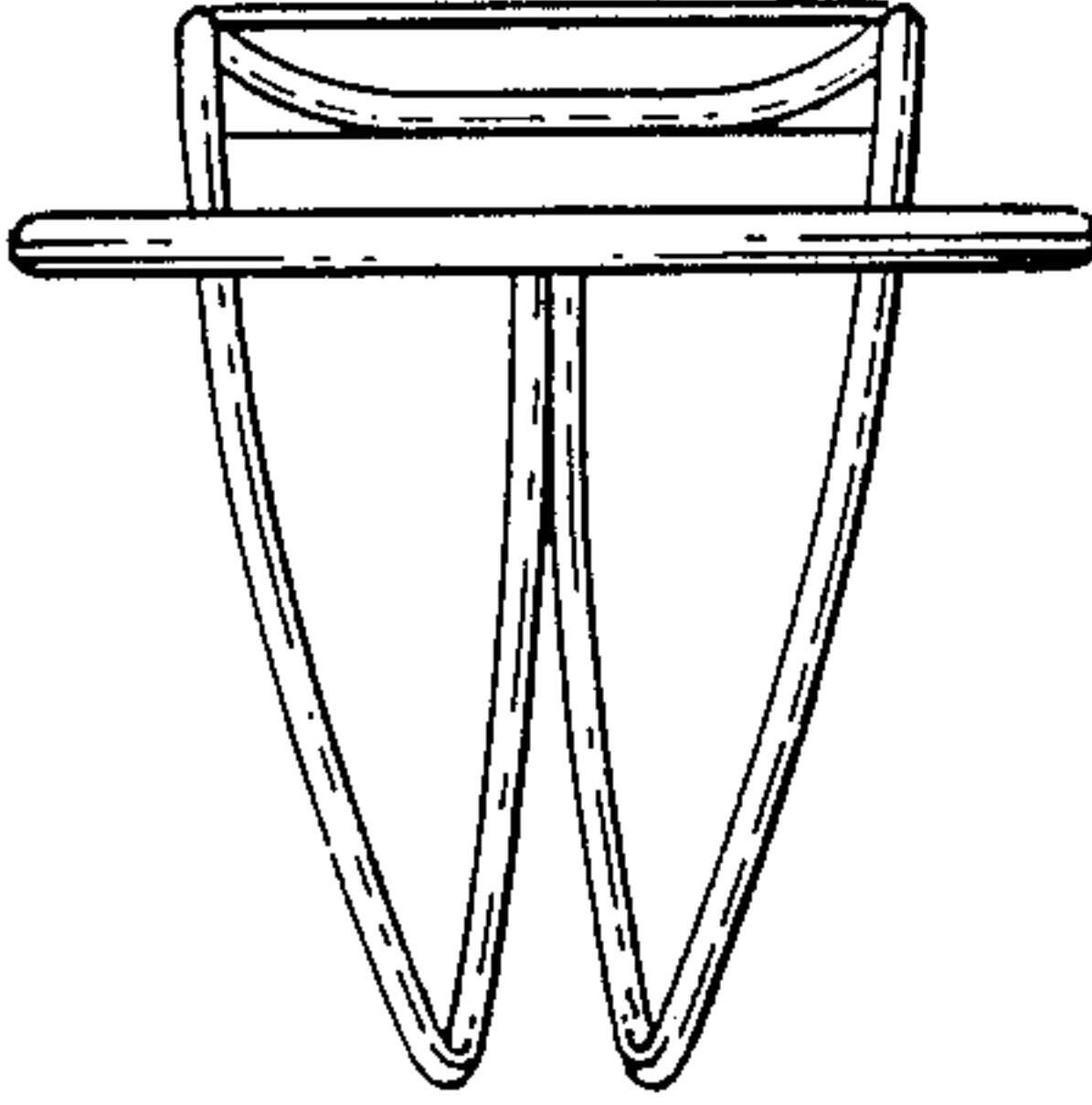

Fig. 5

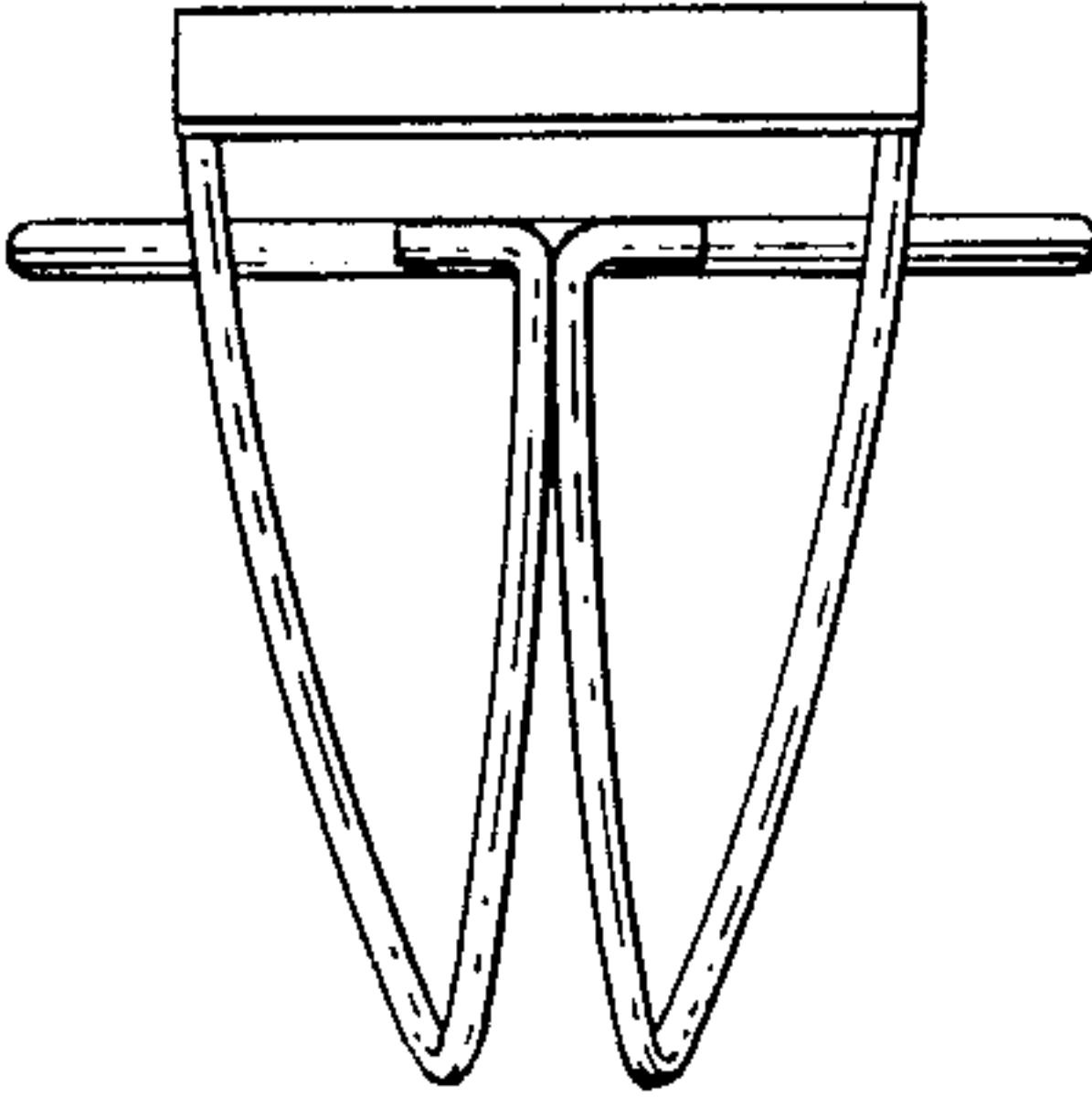

Fig. 6

