

[54] MICRODISSECTOMY CURETTE HANDLE

[76] Inventor: Gary K. Michelson, 438 Sherman Canal, Venice, Calif. 90291

[**] Term: 14 Years

[21] Appl. No.: 121,597

[22] Filed: Nov. 16, 1987

[52] U.S. Cl. D24/30; D8/107; D24/26

[58] Field of Search D24/30, 26-28; 128/757, 758, 760; 606/160, 161; D8/107, 94, 83, 8, DIG. 4

[56] References Cited

U.S. PATENT DOCUMENTS

- D. 256,768 9/1980 Irelan D8/8 X
- D. 275,127 8/1984 Edwards D24/48 X
- 1,080,929 12/1913 Romeo 606/160
- 4,572,180 2/1986 Deenadaylu 606/161

Primary Examiner—A. Hugo Word
Assistant Examiner—Stella M. Reid
Attorney, Agent, or Firm—Lewis Anten

[57] CLAIM

The ornamental design for a microdissectomy curette handle, as shown and described.

DESCRIPTION

FIG. 1 is a right side perspective view of a microdissectomy curette handle, showing my new design;
 FIG. 2 is a right side elevational view thereof, the left side elevational view being a mirror image;
 FIG. 3 is a top plan view thereof;
 FIG. 4 is a bottom plan view thereof;
 FIG. 5 is a left end elevational view thereof;
 FIG. 6 is a right end elevational view thereof;
 FIG. 7 is a right side perspective view of a second embodiment of FIG. 1;
 FIG. 8 is a right side elevational view thereof, the left side elevational view being a mirror image;
 FIG. 9 is a top plan view thereof;
 FIG. 10 is a bottom plan view thereof;
 FIG. 11 is a left end elevational view thereof; and
 FIG. 12 is a right end elevational view thereof.
 The broken line showing in FIGS. 1-4 and 7-9 is for illustrative purposes only and forms no part of the claimed design.

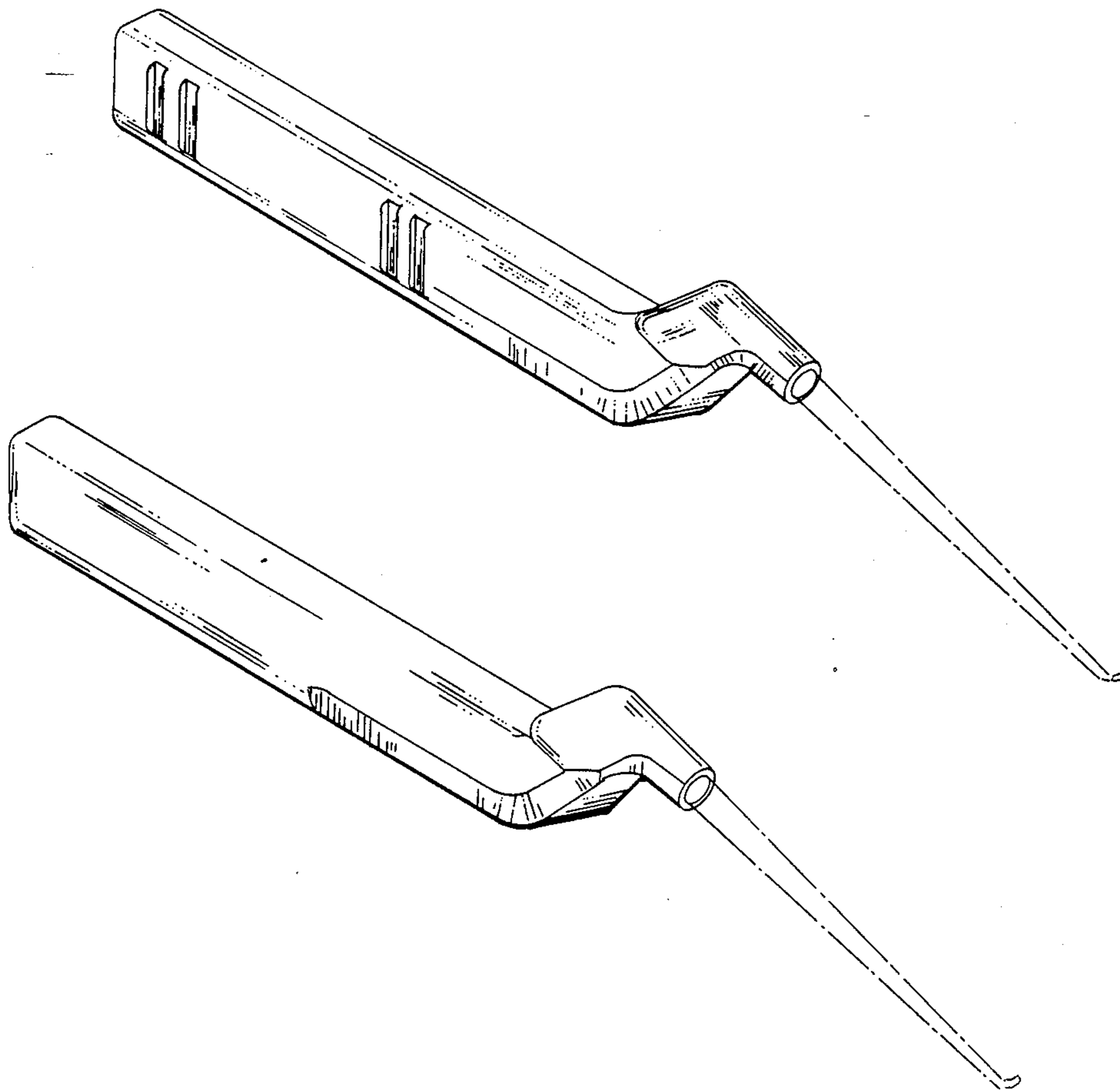

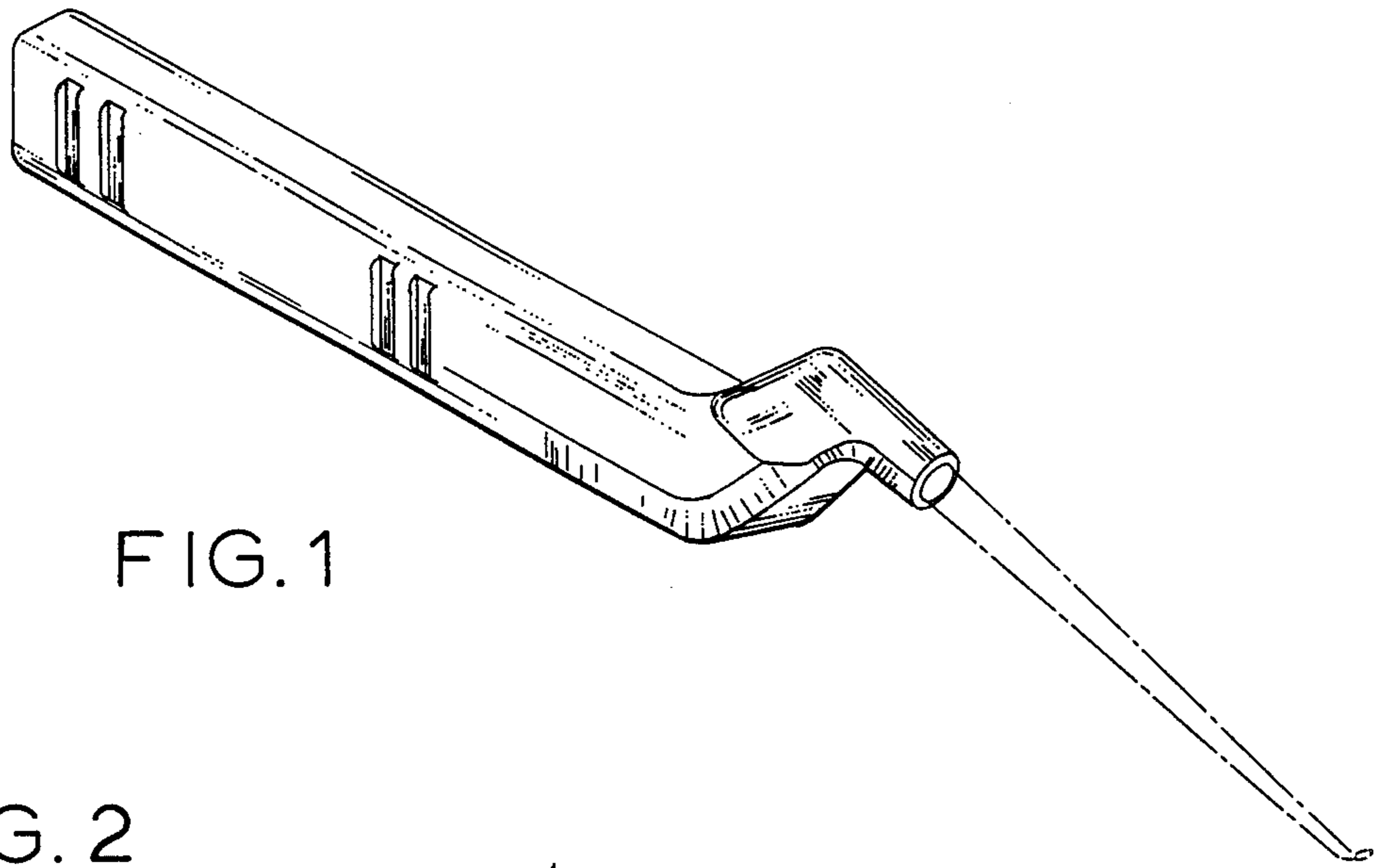

FIG. 1

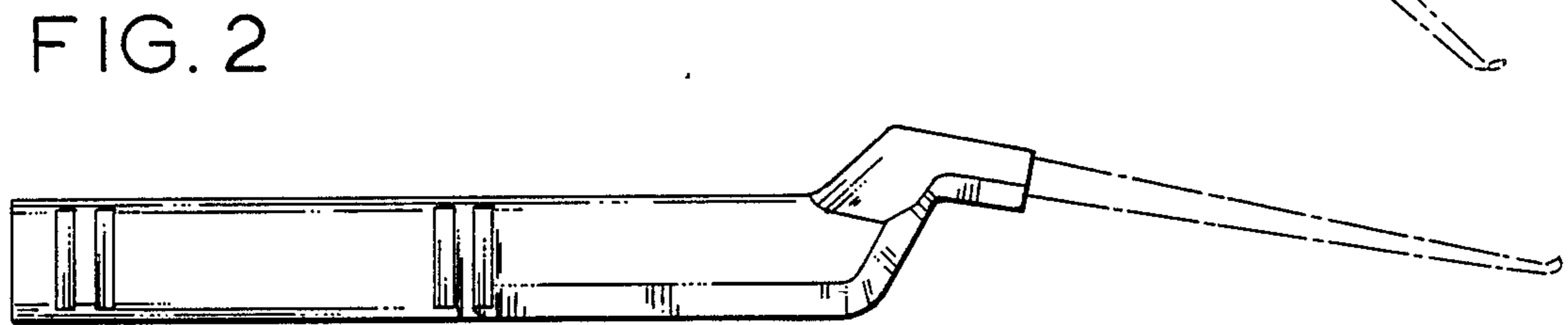

FIG. 2

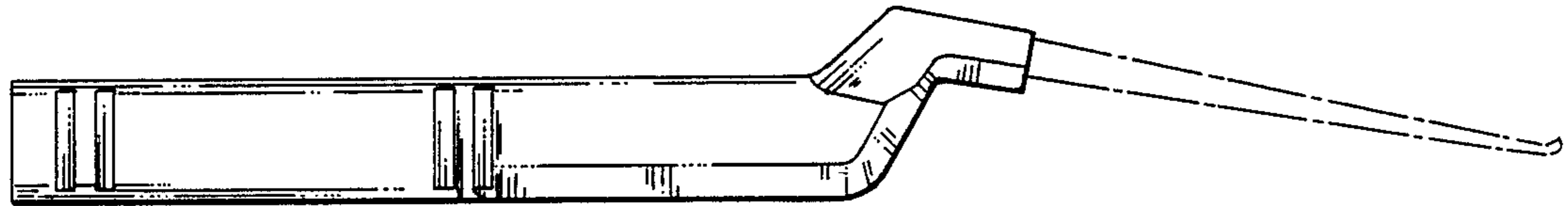

FIG. 3



FIG. 4

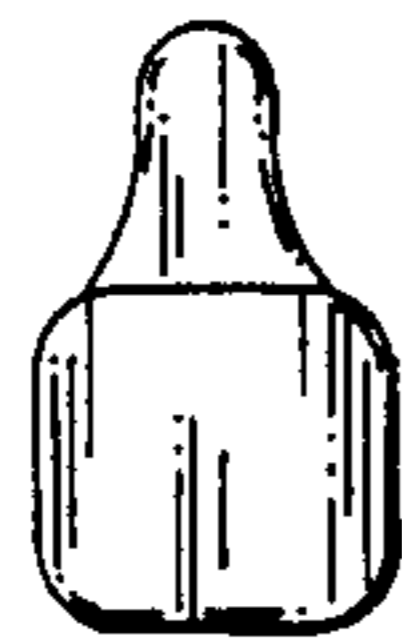
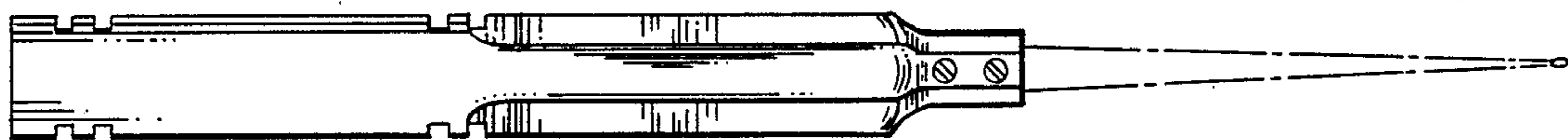

FIG. 5



FIG. 6

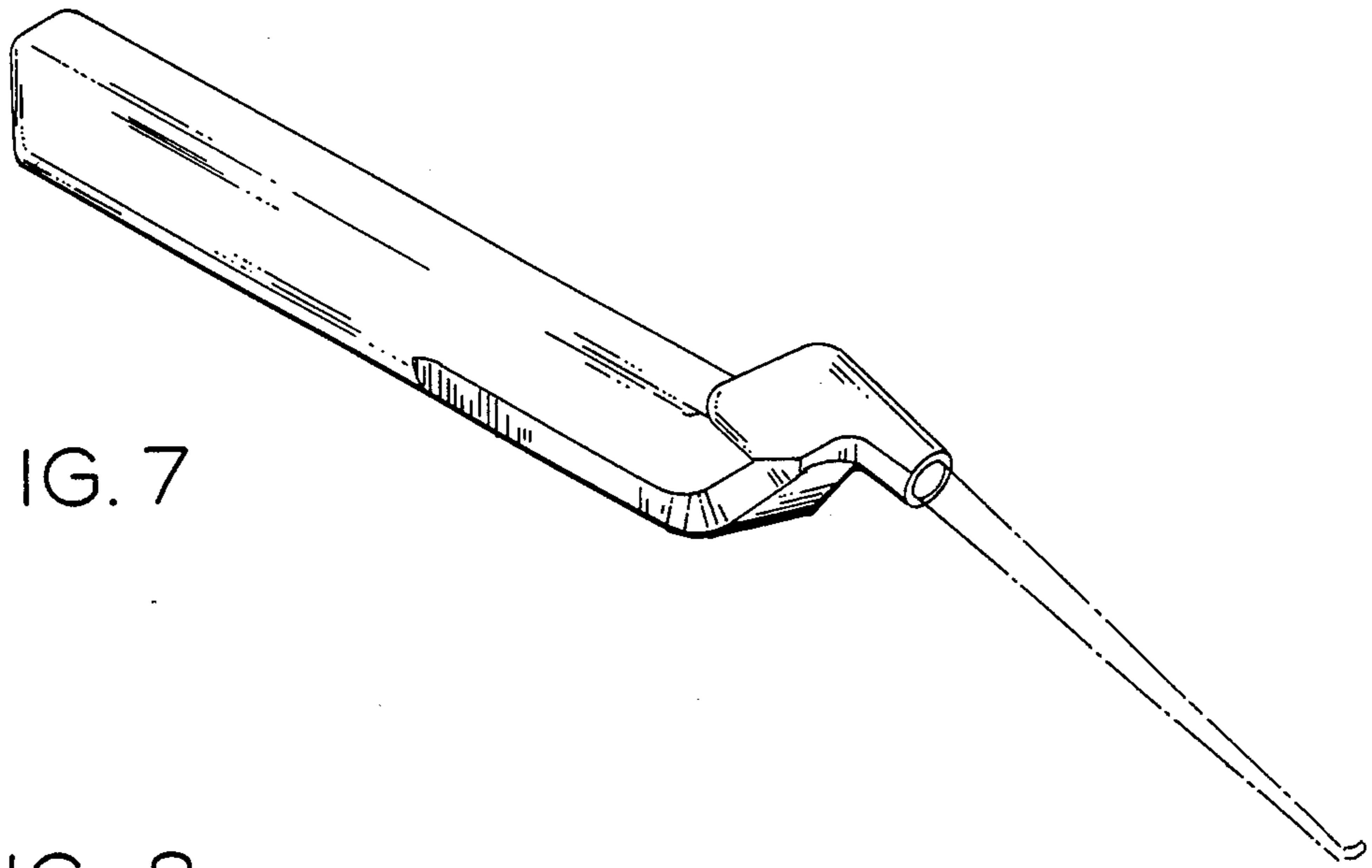

FIG. 7

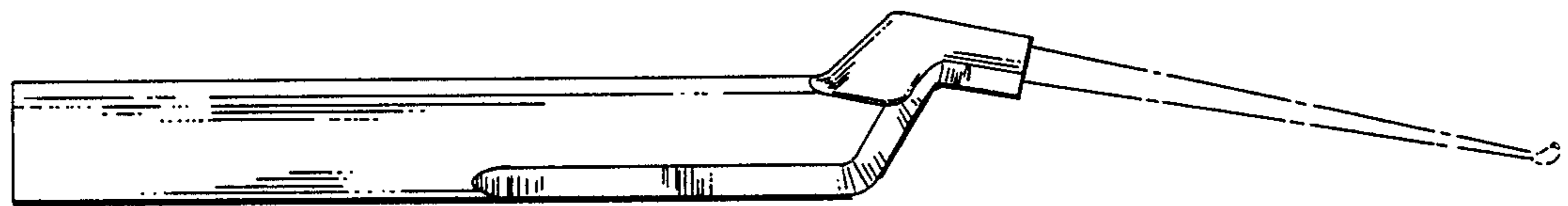

FIG. 8

FIG. 9



FIG. 10

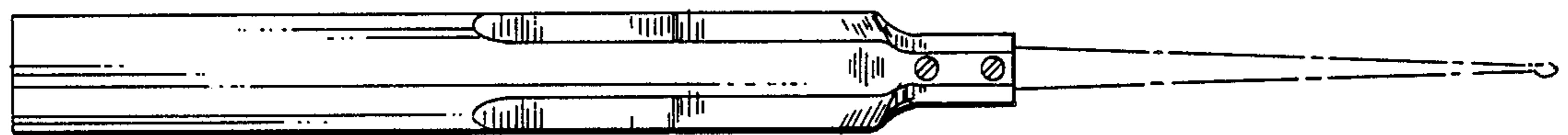

FIG. 11

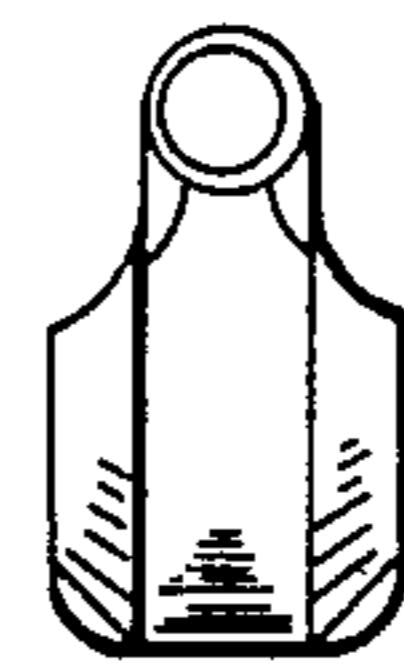

FIG. 12