

[54] **PHOTOCOPY MACHINE**

[75] **Inventor: Eugene A. Helmetsie, Spencer, N.Y.**

[73] **Assignee: Ozalid Corporation, Binghamton, N.Y.**

[\*\*] **Term: 14 Years**

[21] **Appl. No.: 154,618**

[22] **Filed: Feb. 10, 1988**

[52] **U.S. Cl. .... D18/36**

[58] **Field of Search ..... D18/13, 36-40;  
D14/107, 111, 114; 355/200, 210, 233, 234**

[56] **References Cited**

**U.S. PATENT DOCUMENTS**

D. 177,050	3/1956	Jones et al. ....	D18/36
D. 200,739	3/1965	Isikawa .....	D18/36
D. 279,985	8/1985	Thom .....	D14/111
D. 285,807	9/1986	Otsuka .....	D18/13

**OTHER PUBLICATIONS**

The Xerox 2510 Engineering Copier Brochure; 9/1986.

*Primary Examiner*—Nelson C. Holtje  
*Assistant Examiner*—Caron D. Veynar  
*Attorney, Agent, or Firm*—Kane, Dalsimer, Sullivan,  
Kurucz, Levy, Eisele and Richard

[57] **CLAIM**

The ornamental design for a photocopier machine, as shown and described.

**DESCRIPTION**

FIG. 1 is a top left perspective view of a photocopier machine showing my new design;  
FIG. 2 is a top plan view thereof;  
FIG. 3 is a left side elevational view thereof;  
FIG. 4 is a front elevational view thereof;  
FIG. 5 is a bottom plan view thereof;  
FIG. 6 is a rear elevational view thereof;  
FIG. 7 is a right side elevational view thereof.

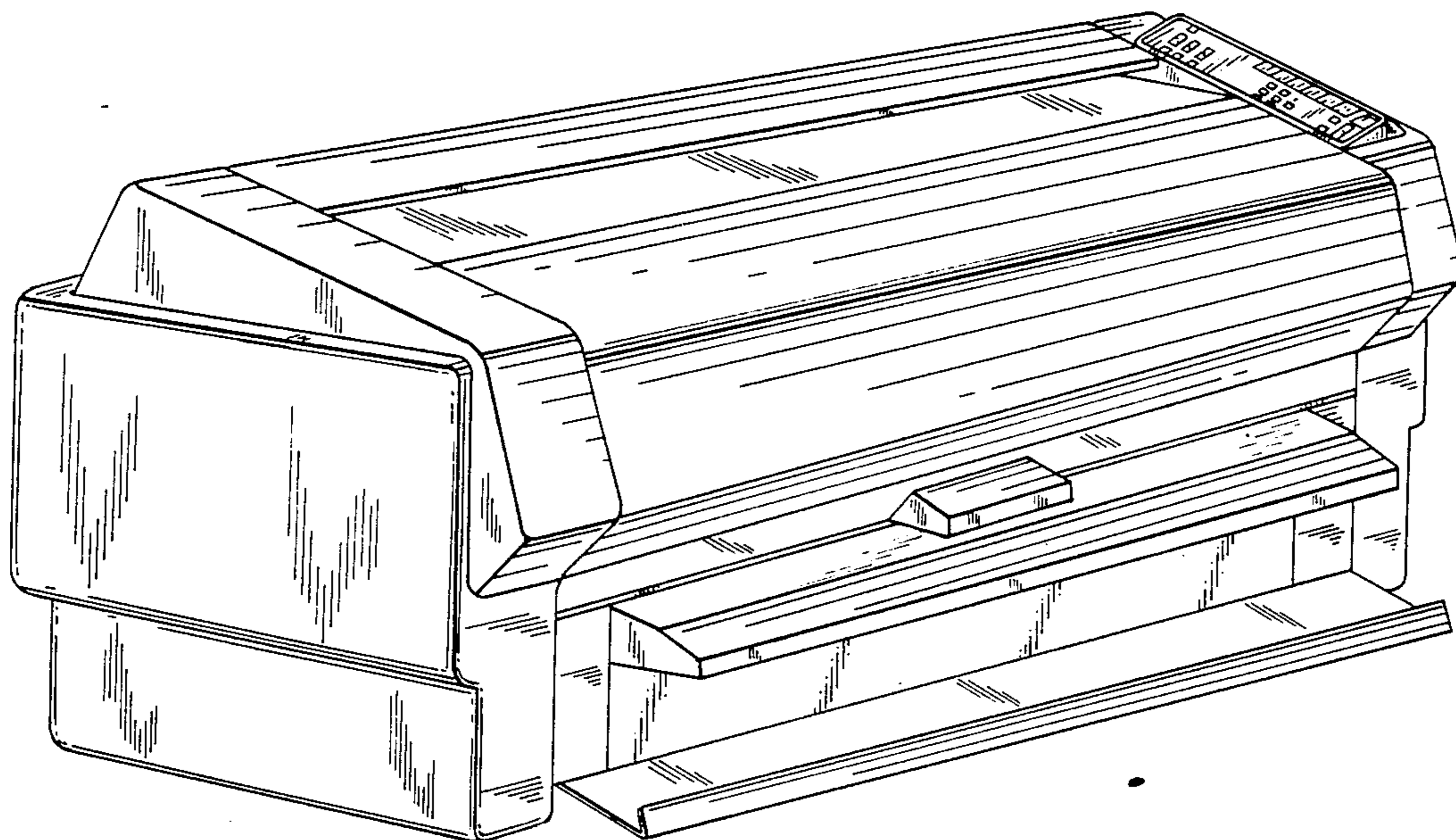

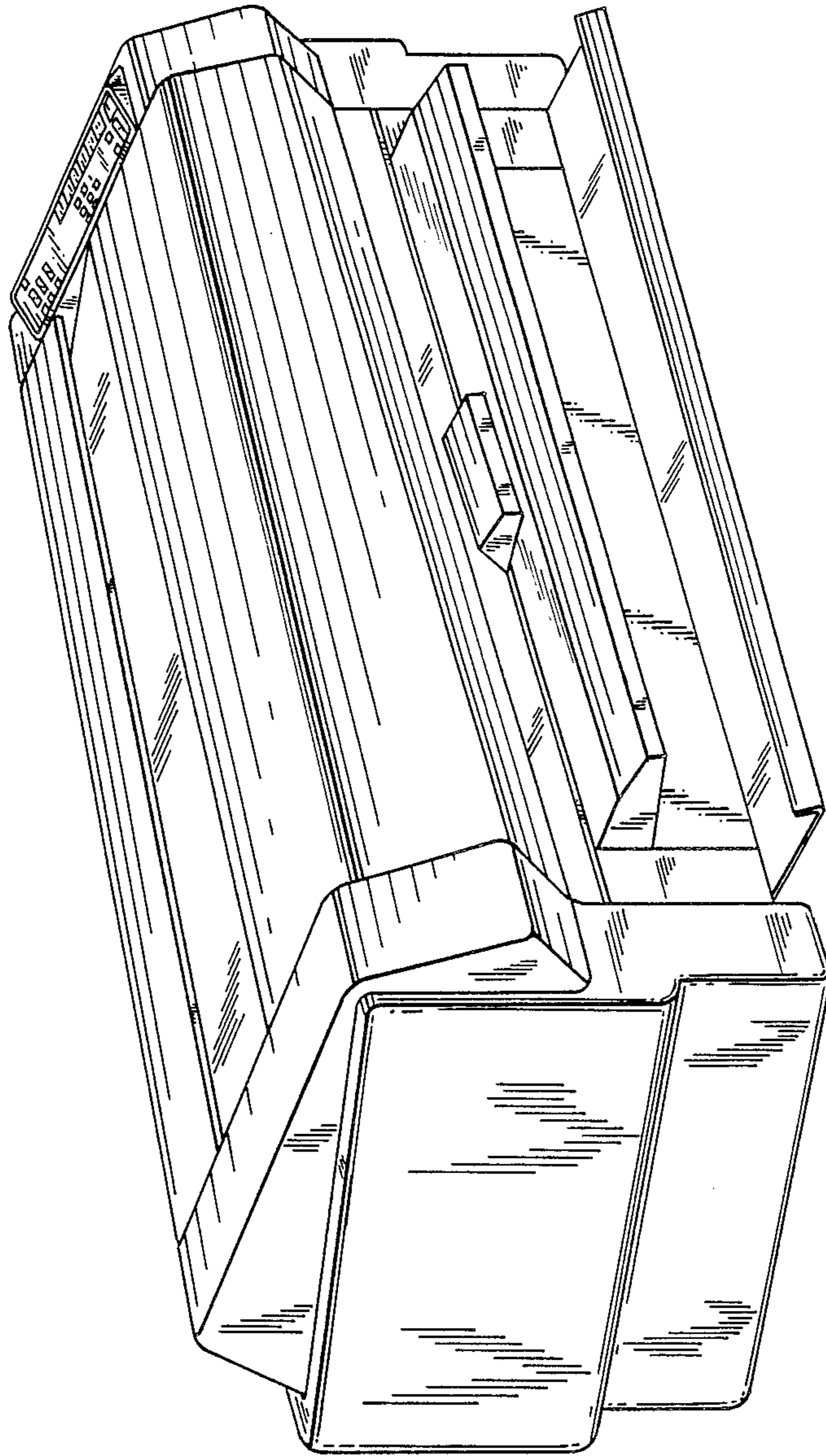

FIG. 1

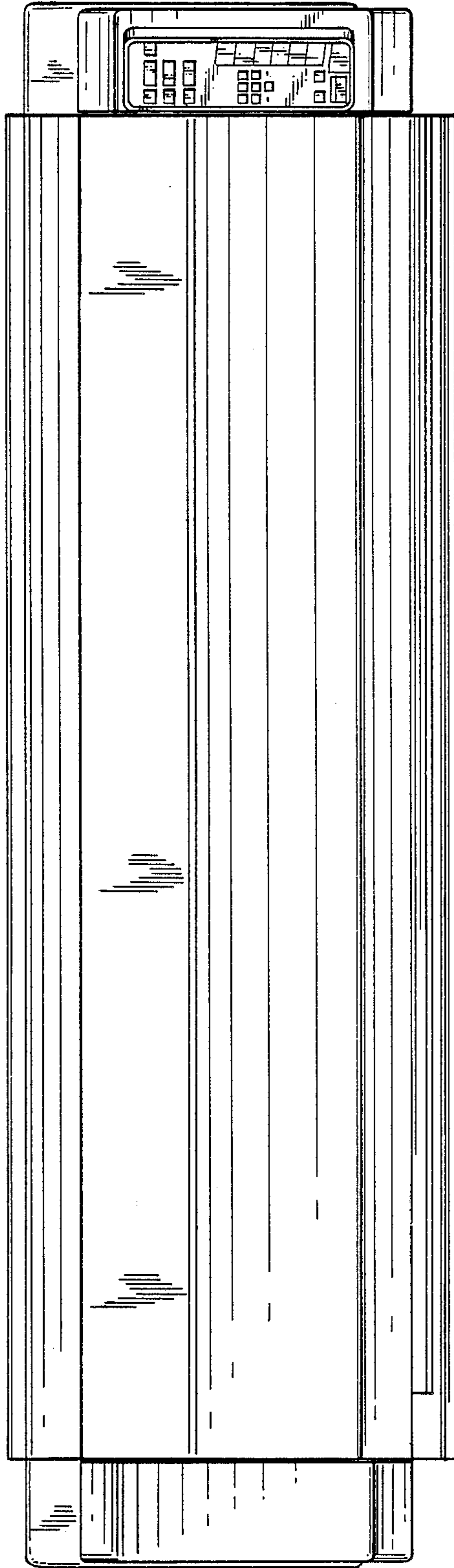

FIG. 2

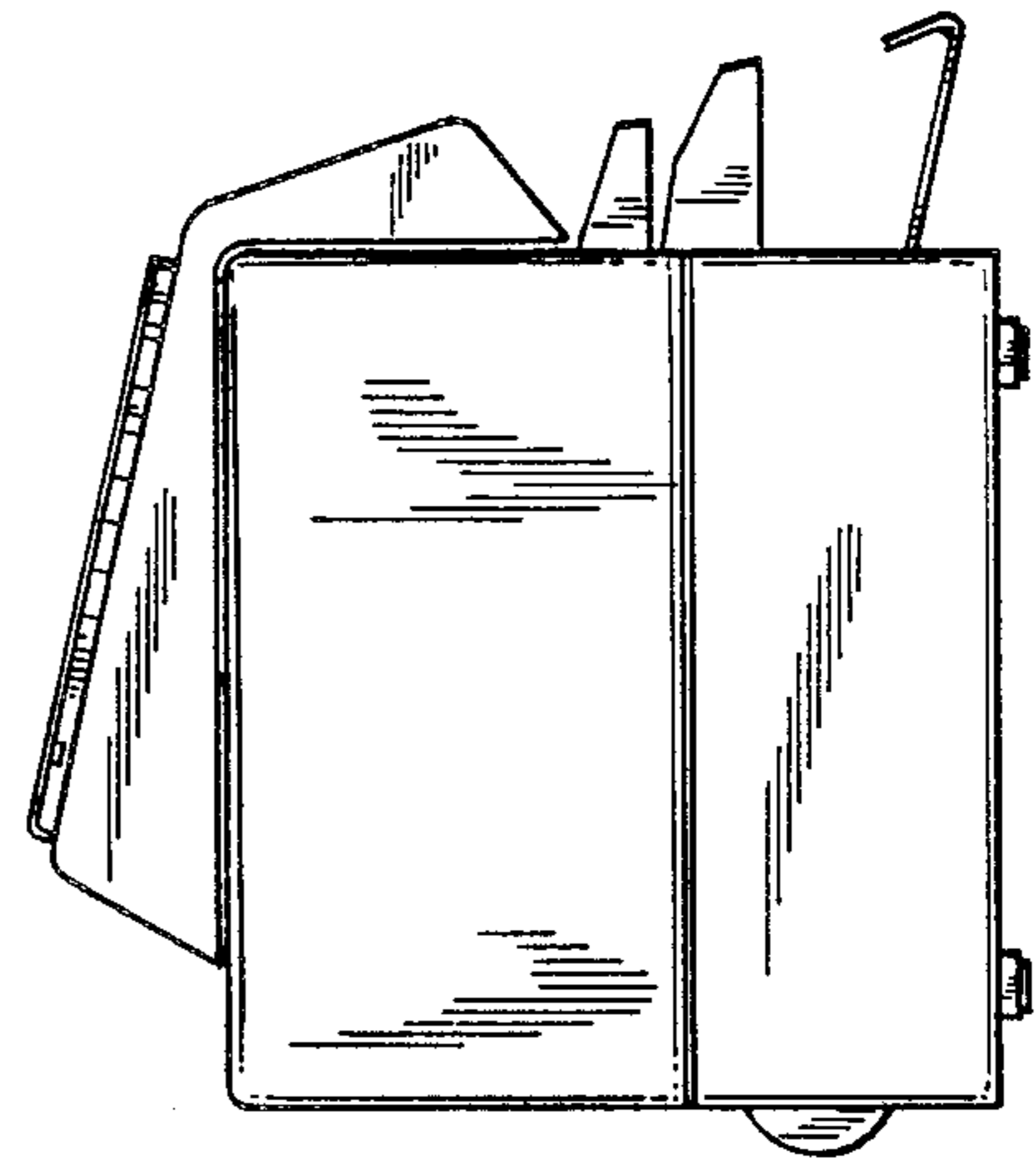

FIG. 3

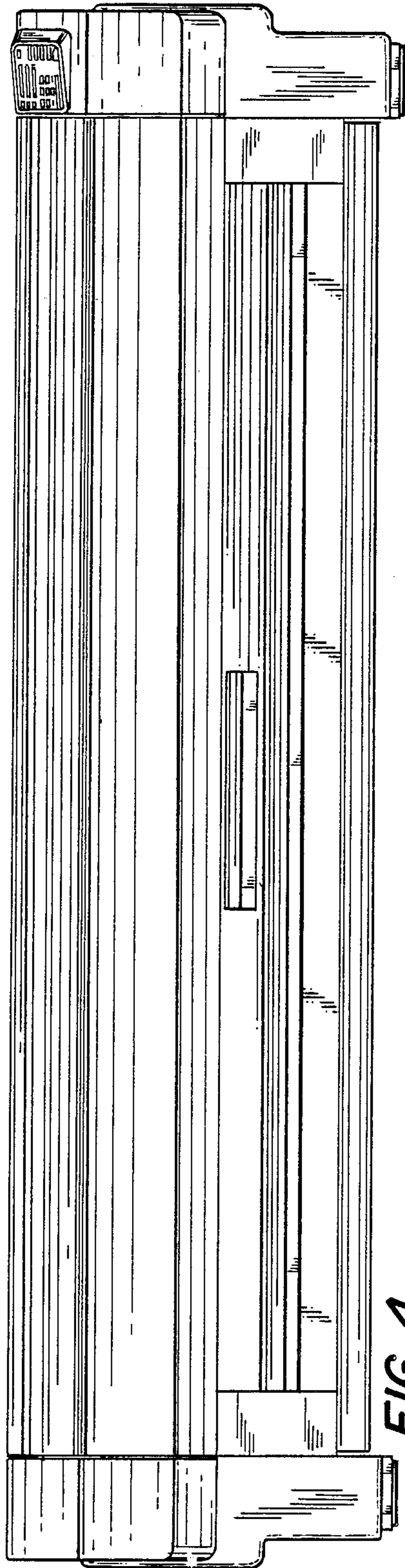
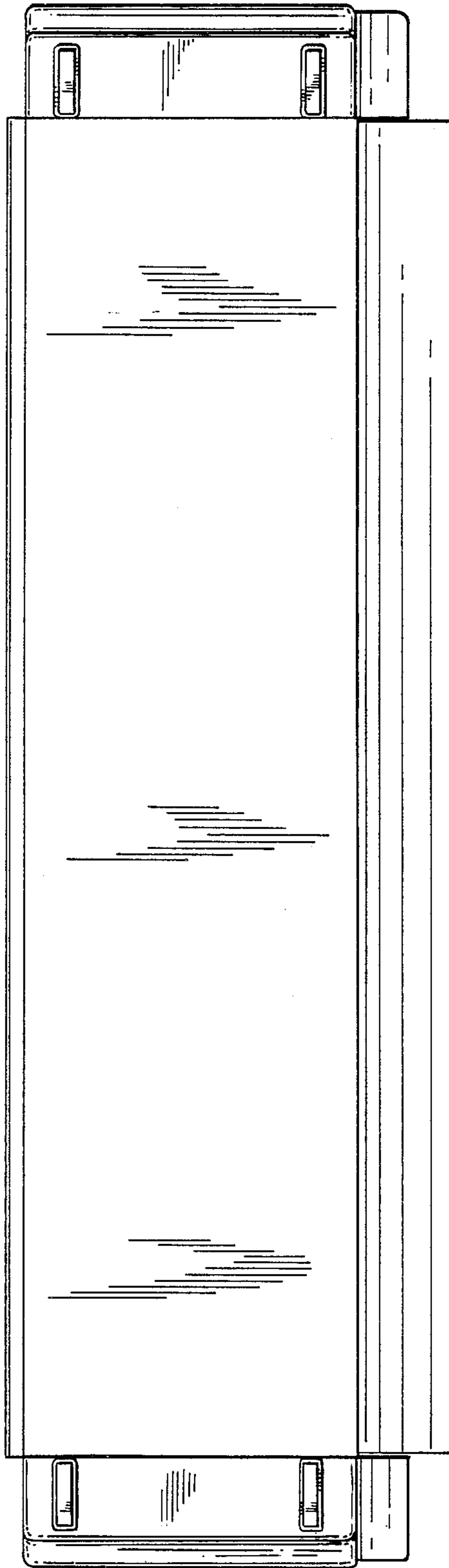

FIG. 4

FIG. 5



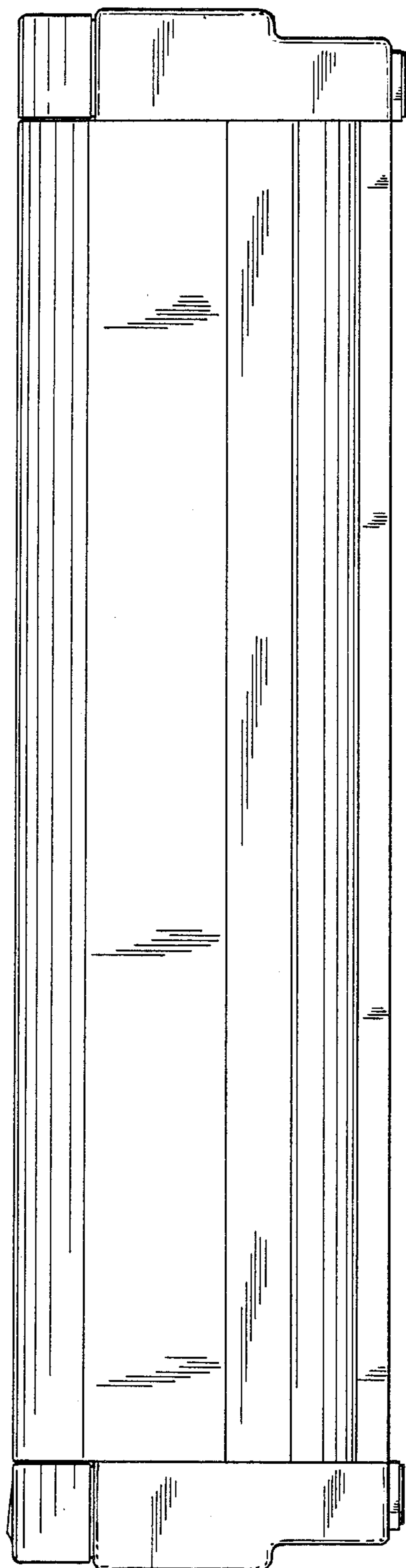

FIG. 6

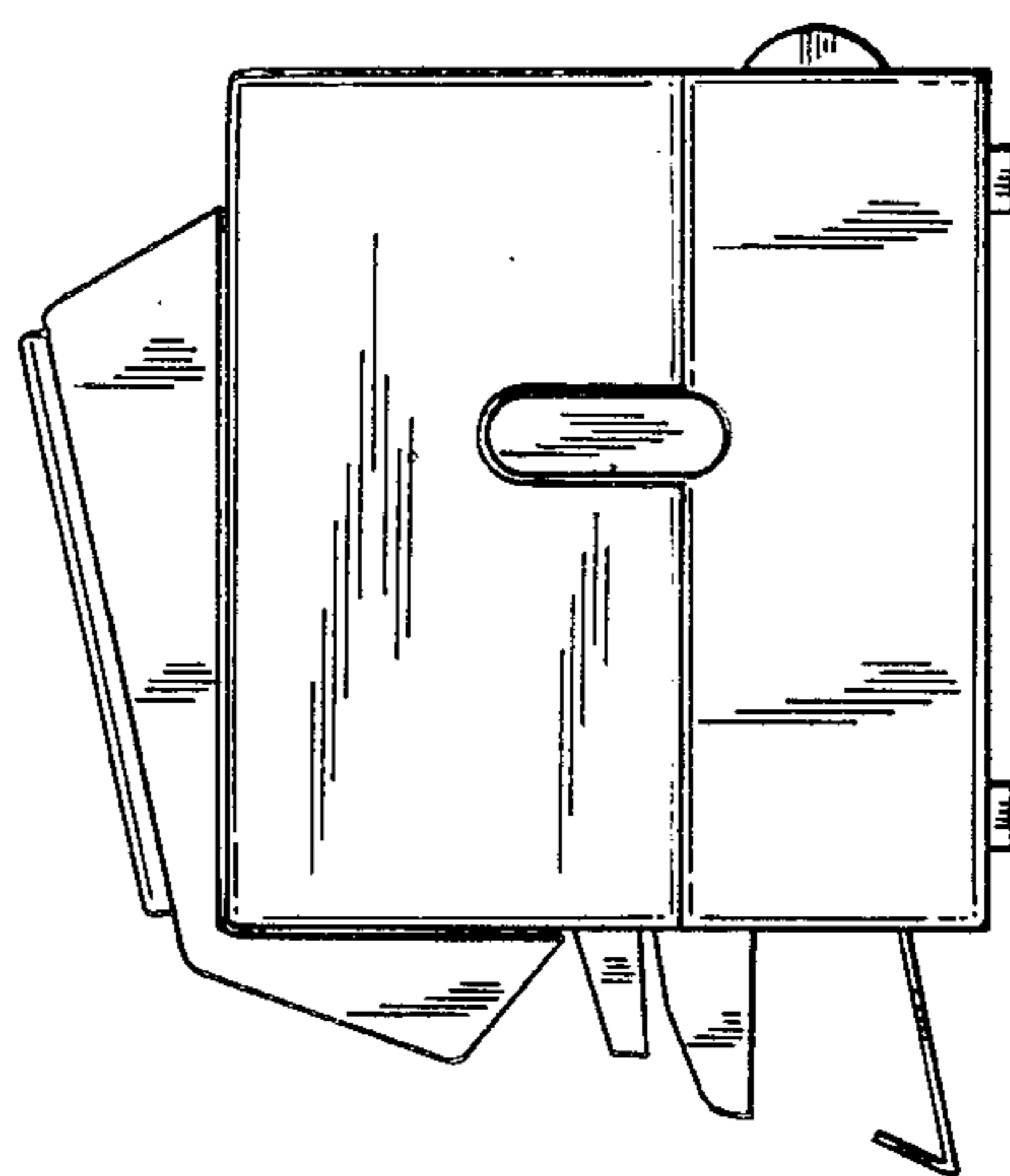

FIG. 7