

[54] TRASH CAN

[76] Inventor: Marc J. Calvi, 24 Salmon Falls
Estates, Rochester, N.H. 03867

[**] Term: 14 Years

[21] Appl. No.: 210,302

[22] Filed: Jun. 22, 1988

[52] U.S. Cl. D34/7

[58] Field of Search D34/1, 7, 8, 9, 11;
220/1 T, 262, 263, 18, 231; D7/17, 313

[56] References Cited

U.S. PATENT DOCUMENTS

- | | | | |
|------------|---------|-----------------------------|---------|
| D. 108,642 | 3/1938 | Geibel | D34/9 |
| D. 176,083 | 11/1955 | Reinecke | D34/9 |
| 1,218,449 | 3/1917 | Nickum | 220/1 T |
| 2,626,078 | 1/1953 | Hutchisson, Jr. et al. | D34/7 |

FOREIGN PATENT DOCUMENTS

1281344 11/1960 France 220/1 T

Primary Examiner—Kay H. Chin
Attorney, Agent, or Firm—Jerry T. Kearns

[57] CLAIM

The ornamental design for a trash can, as shown and described.

DESCRIPTION

FIG. 1 is a front elevational view of a trash can showing my new design;
FIG. 2 is a rear elevational view thereof;
FIG. 3 is a left side elevational view thereof;
FIG. 4 is a right side elevational view thereof;
FIG. 5 is a top plan view thereof;
FIG. 6 is a bottom plan view thereof; and,
FIG. 7 is a cross sectional view thereof taken along the line 7 of FIG. 5.

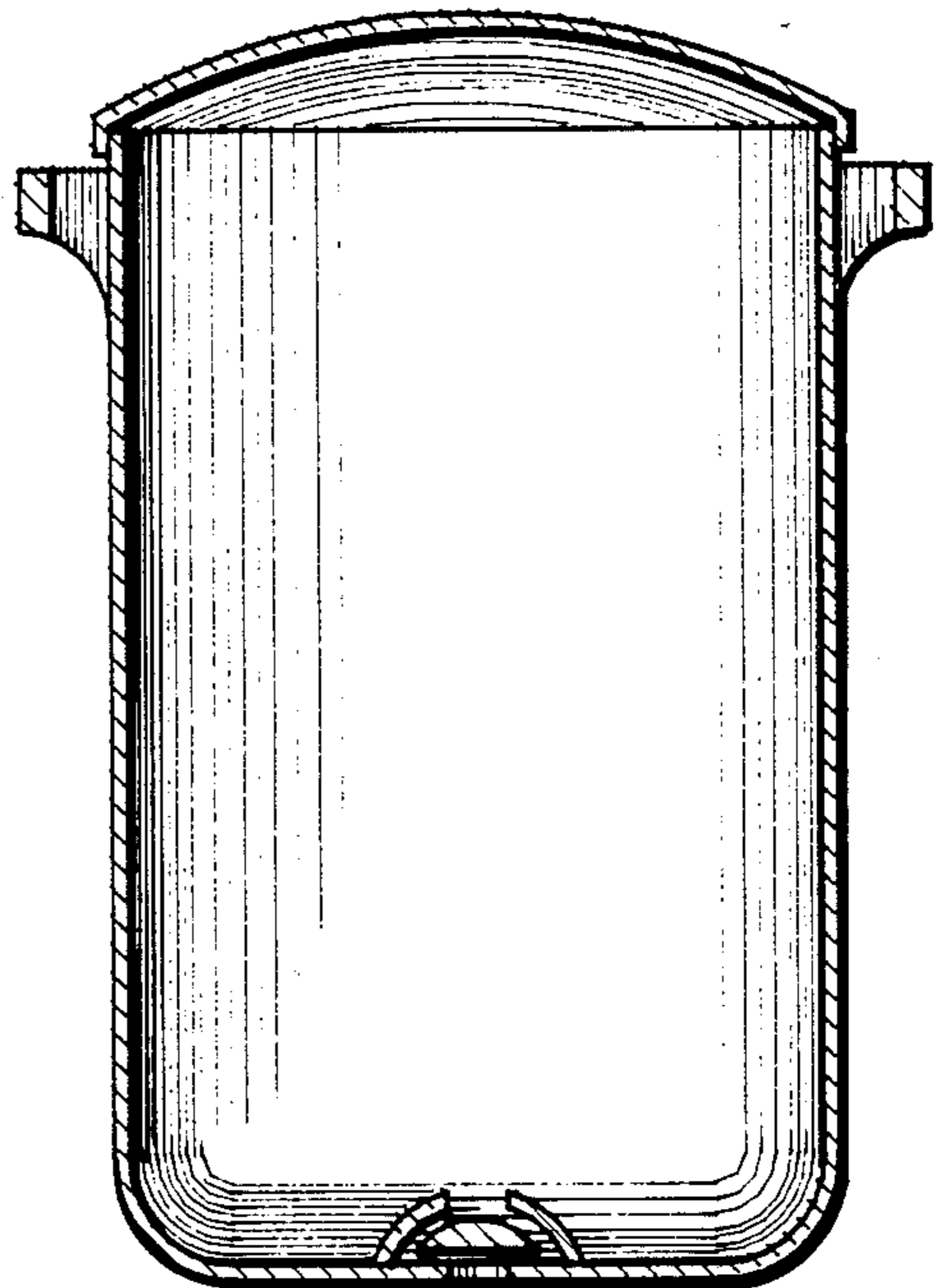
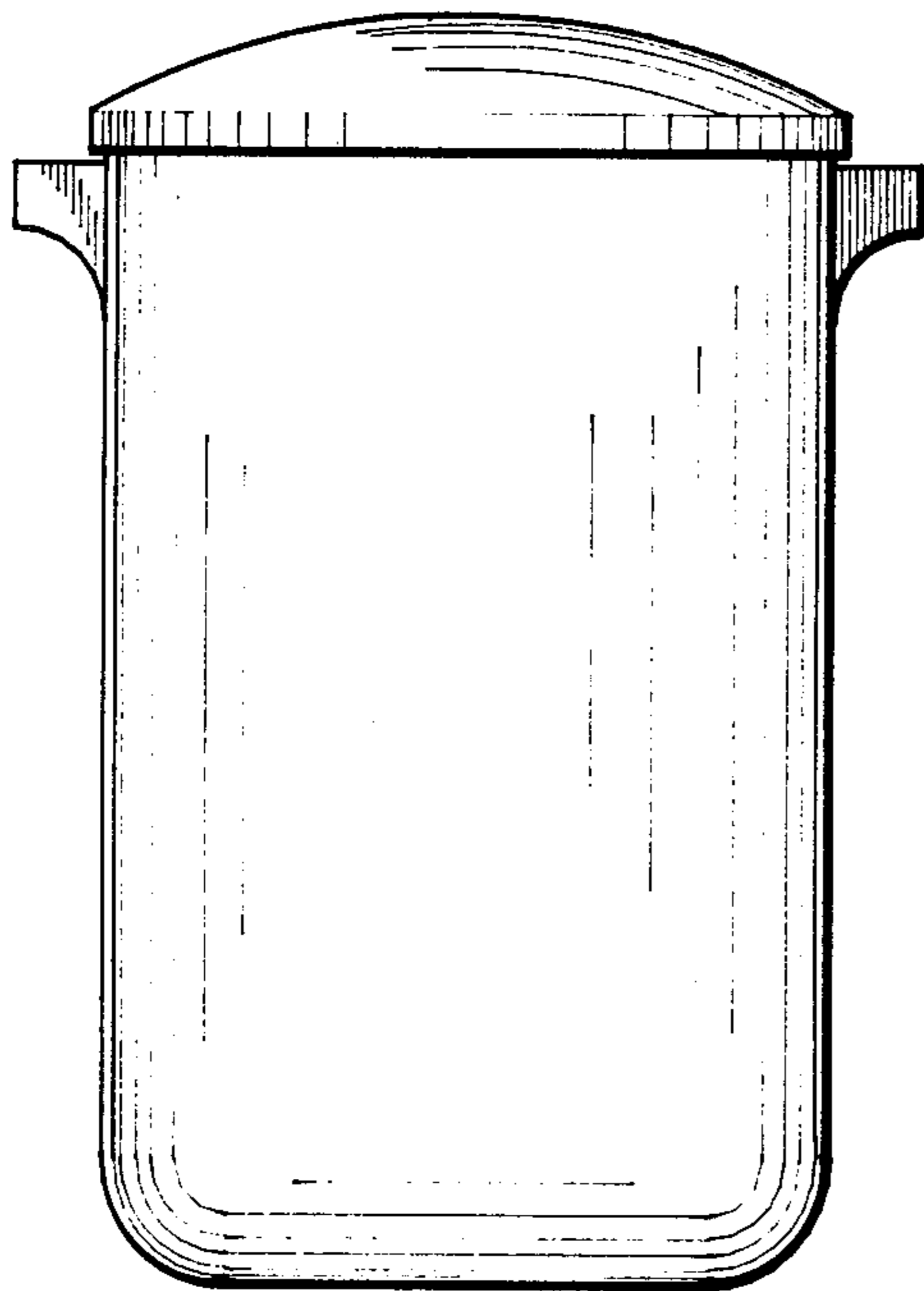

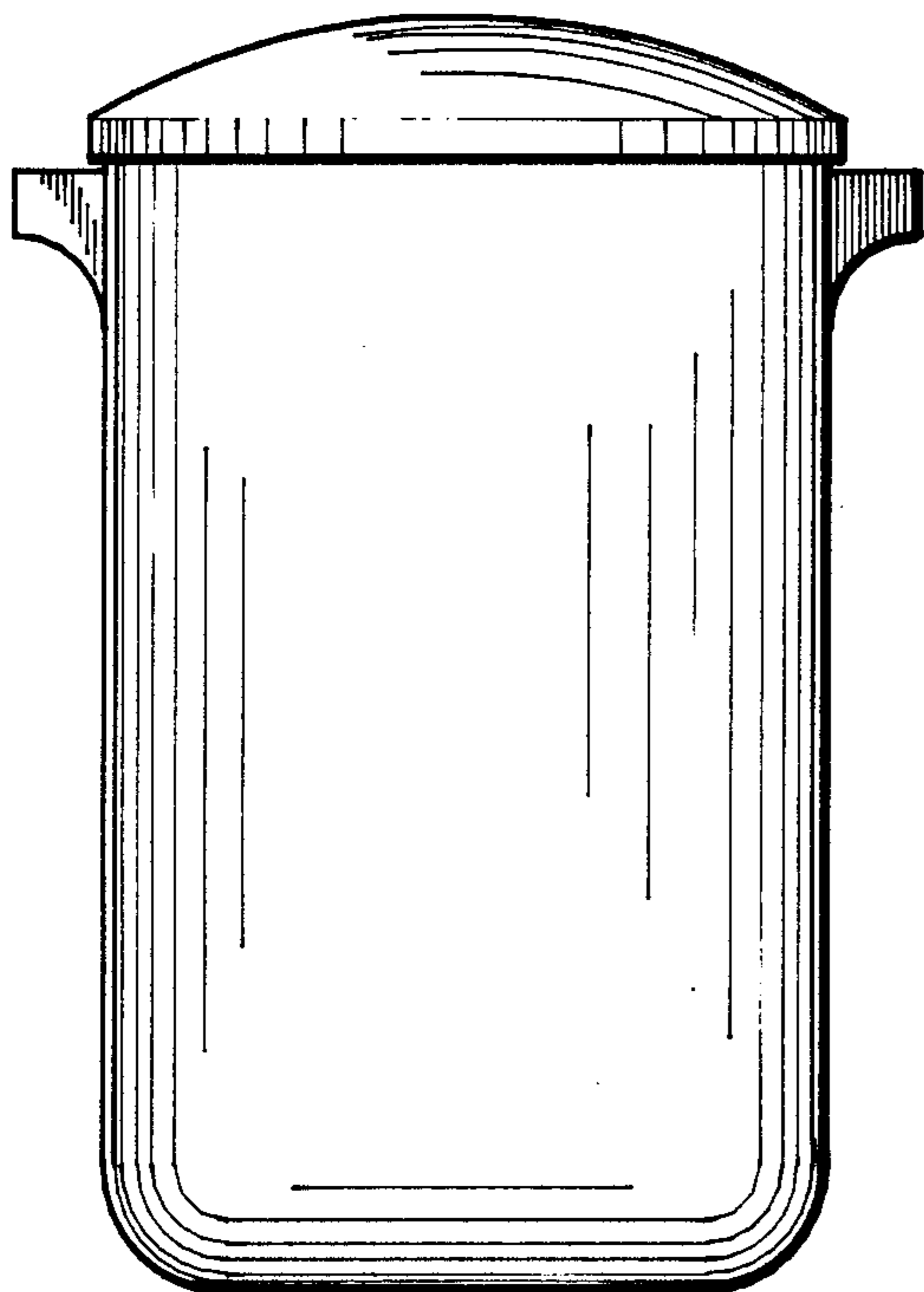

Fig. 1

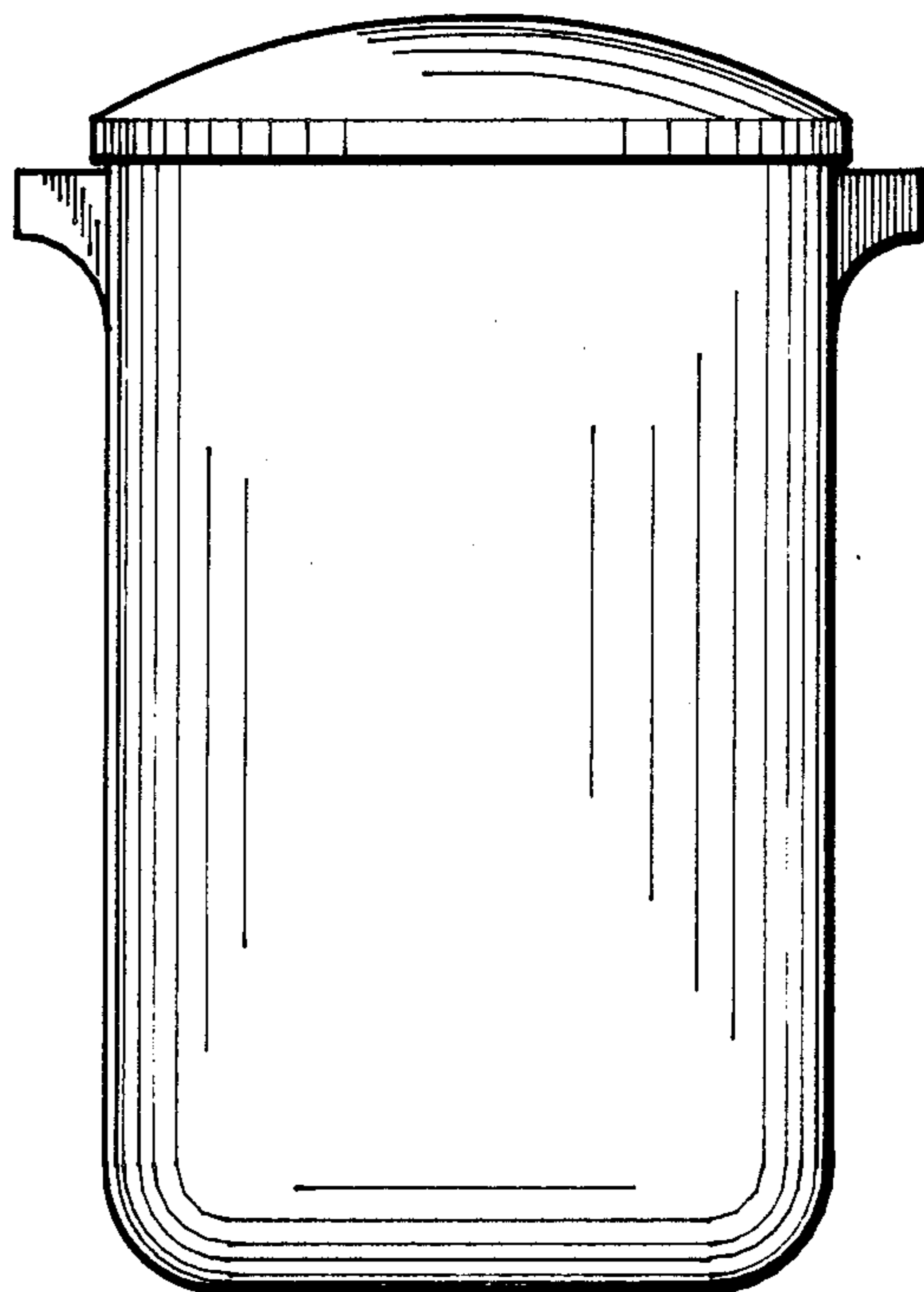

Fig. 2

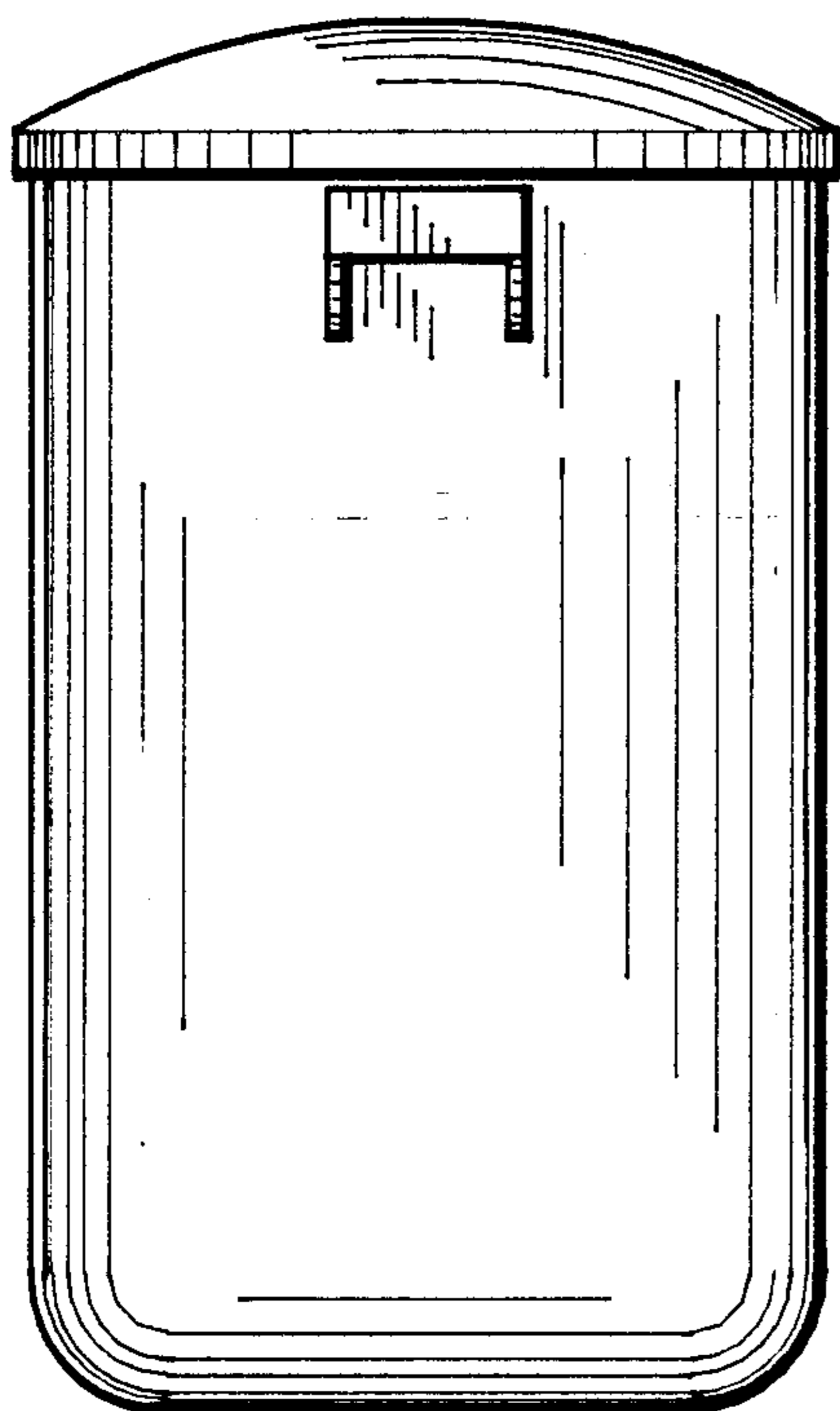

Fig. 3

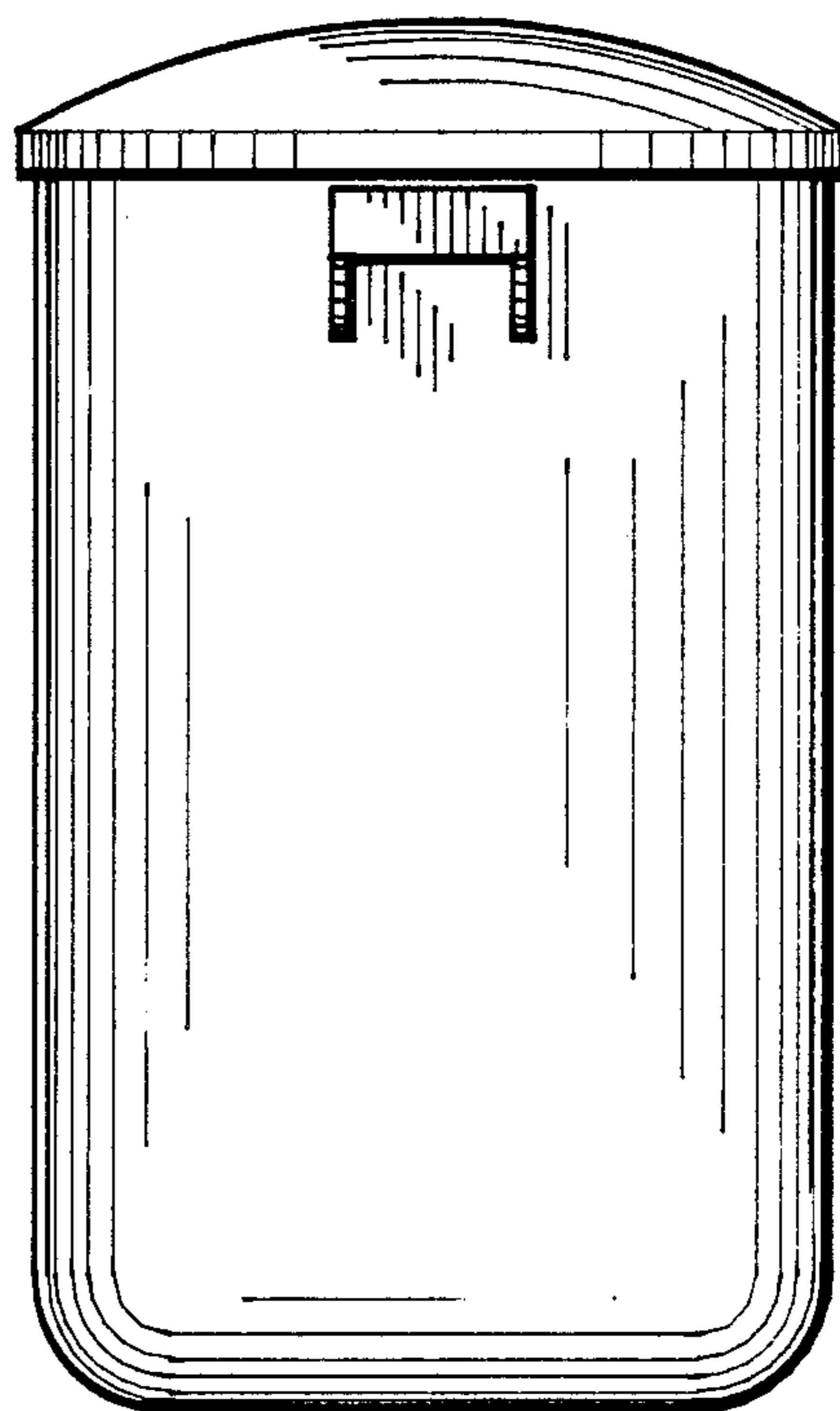

Fig. 4

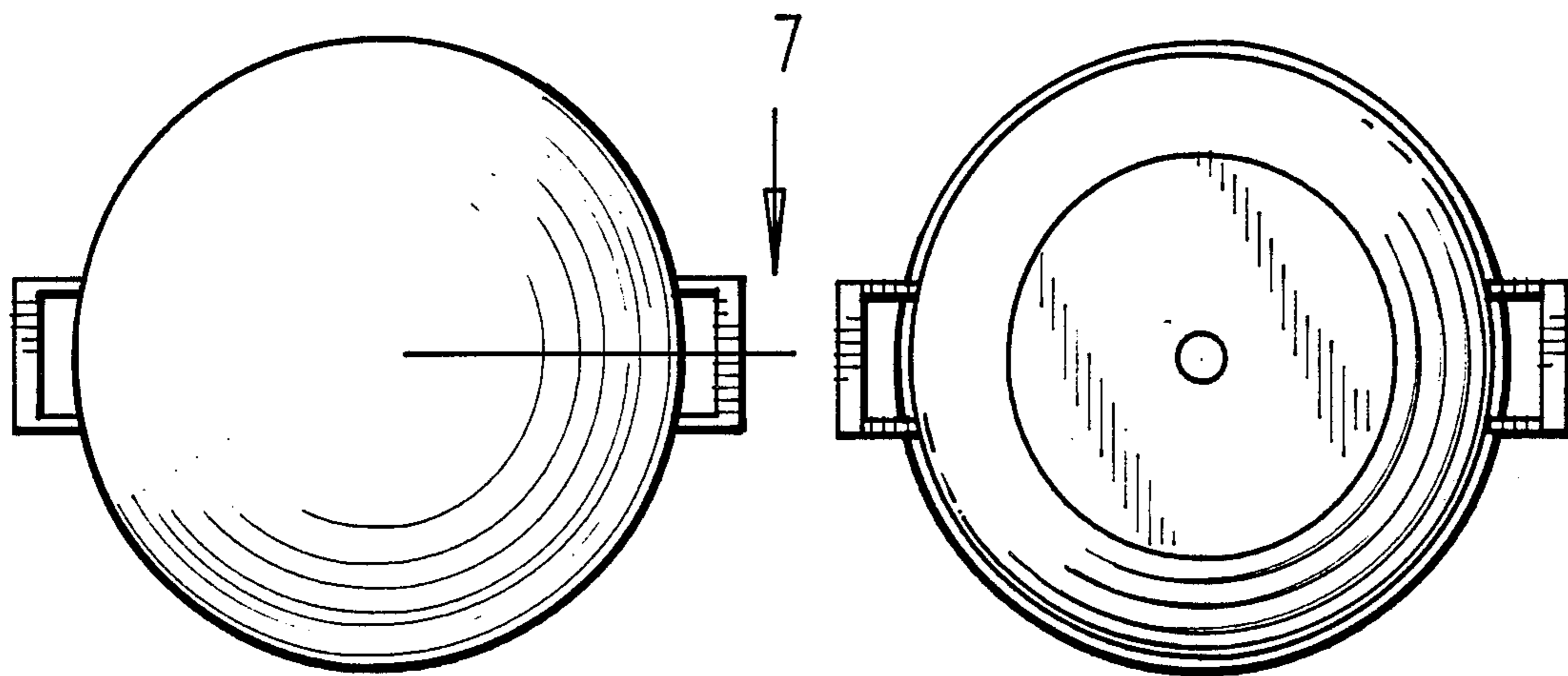

Fig. 5

Fig. 6

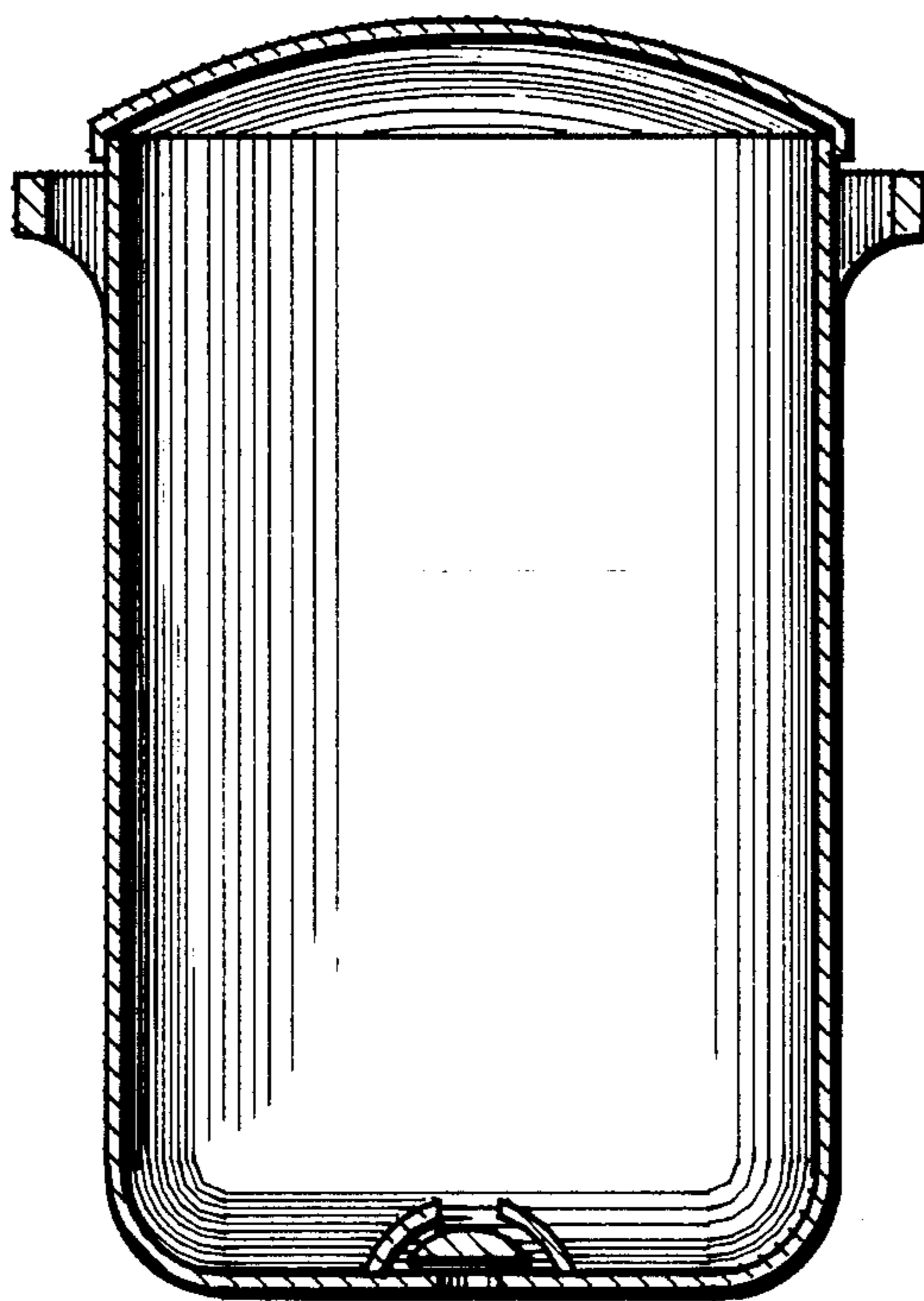

Fig. 7