

[54] COMBINED CHANDELIER AND CEILING FAN

[76] Inventor: Aivan Wang, 6F1,296,Sec.4, Hsin Yih Rd., Taipei, Taiwan

[\*\*] Term: 14 Years

[21] Appl. No.: 171,934

[22] Filed: Mar. 23, 1988

[52] U.S. Cl. .... D26/51; D23/377; D26/88

[58] Field of Search ..... D26/72, 80-92; 362/404, 405, 406; 149/407; 92/408; 96/362, 363, 147; D23/377, 385; 416/5

[56] References Cited

U.S. PATENT DOCUMENTS

- D. 209,247 11/1967 Ayers ..... D23/377
- D. 262,660 1/1982 Fairbanks et al. .... D26/88
- D. 274,354 6/1984 Mezey ..... D23/377

4,721,480 1/1988 Yung ..... 416/5 X

OTHER PUBLICATIONS

Harry Gitlin Lighting Ad., 1977, Downlight (left).

Primary Examiner—Susan J. Lucas  
Attorney, Agent, or Firm—Esso Int'Patent and Trademark Office

[57] CLAIM

The ornamental design for a combined chandelier and ceiling fan, as shown and described.

DESCRIPTION

FIG. 1 is a top perspective view of a combined chandelier and ceiling fan showing my new design;  
 FIG. 2 is a right side elevational view thereof, the left side being a mirror image;  
 FIG. 3 is a front elevational view thereof, the rear being a mirror image;  
 FIG. 4 is a bottom plan view thereof.

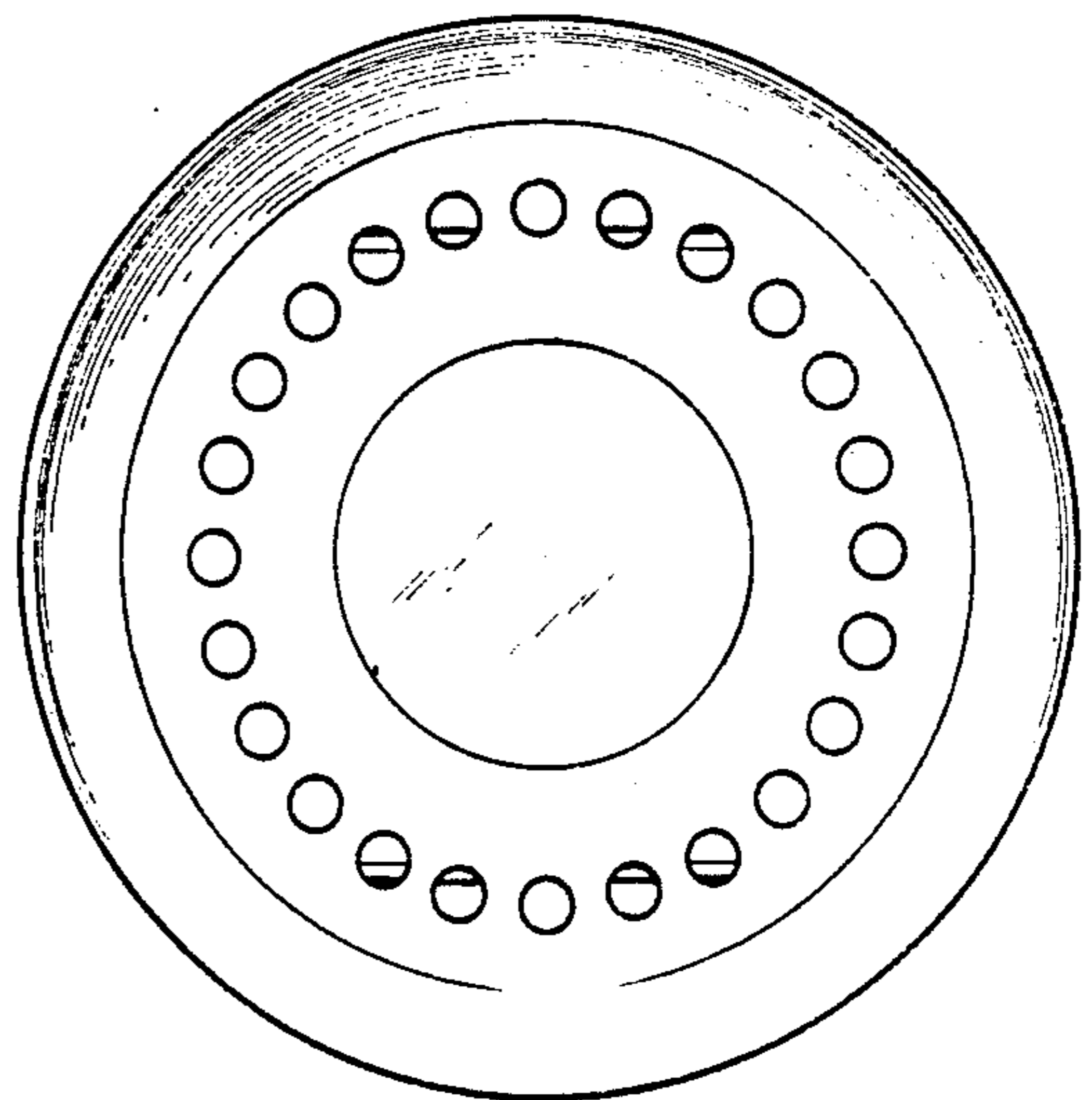
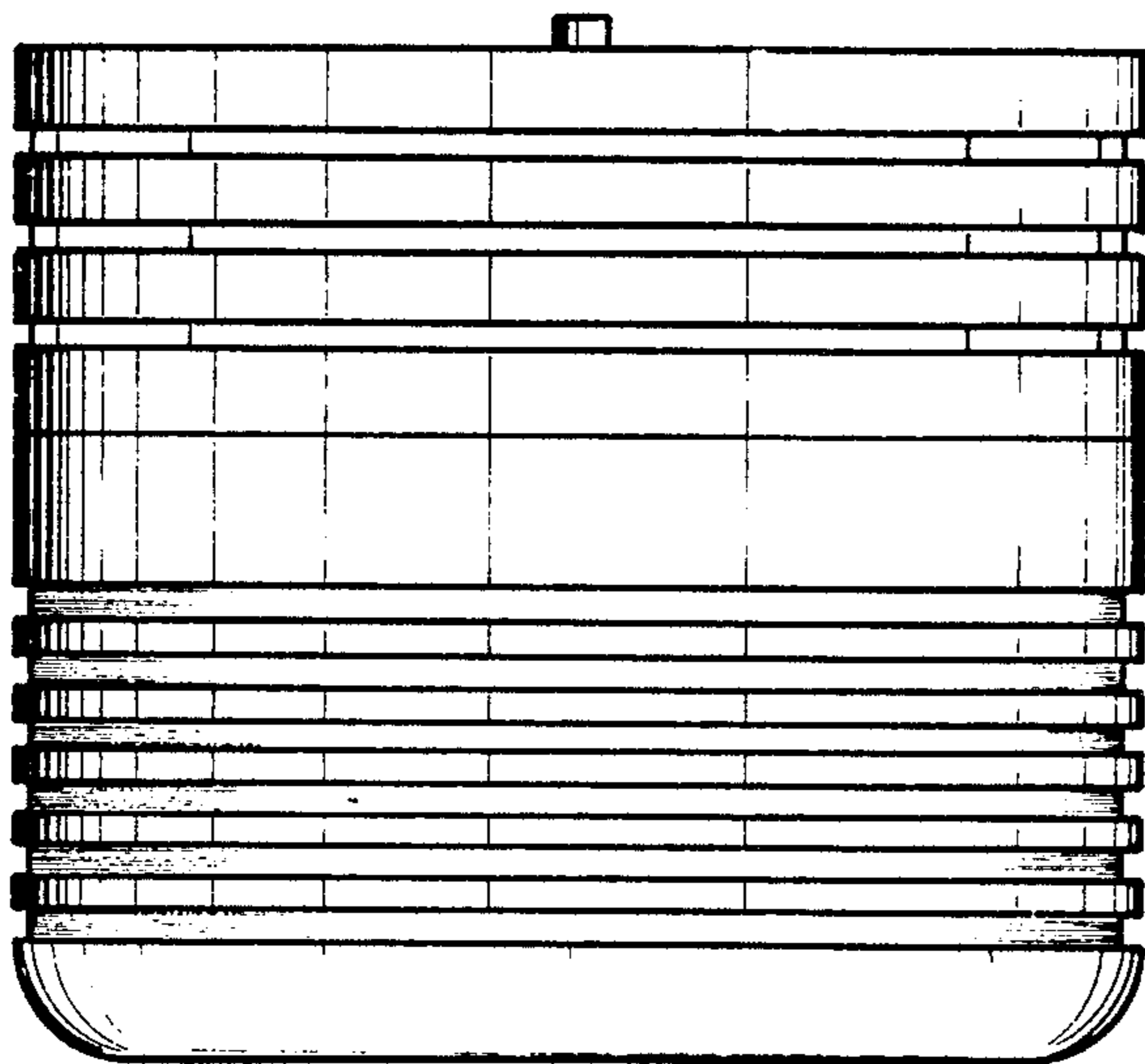

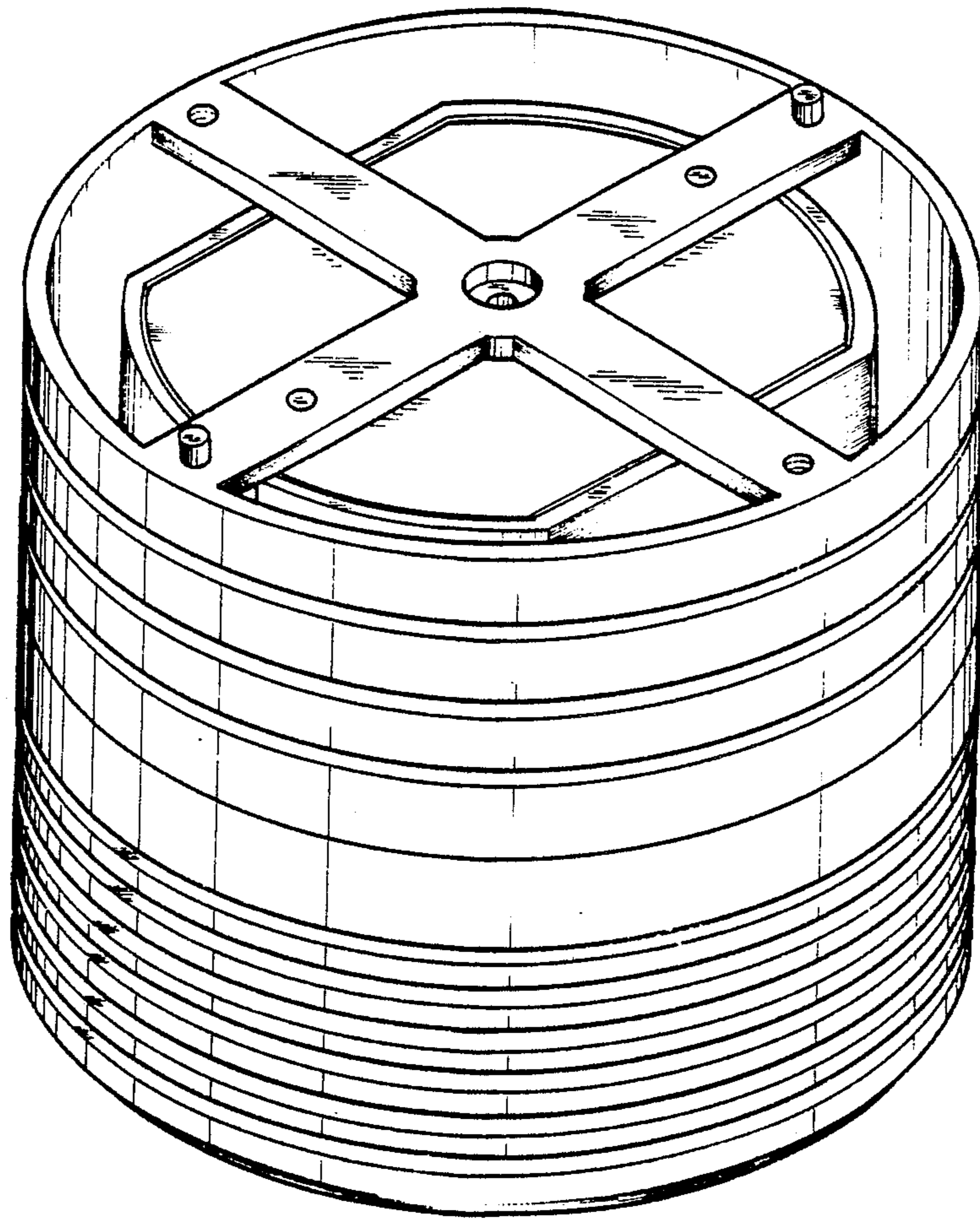

FIG 1

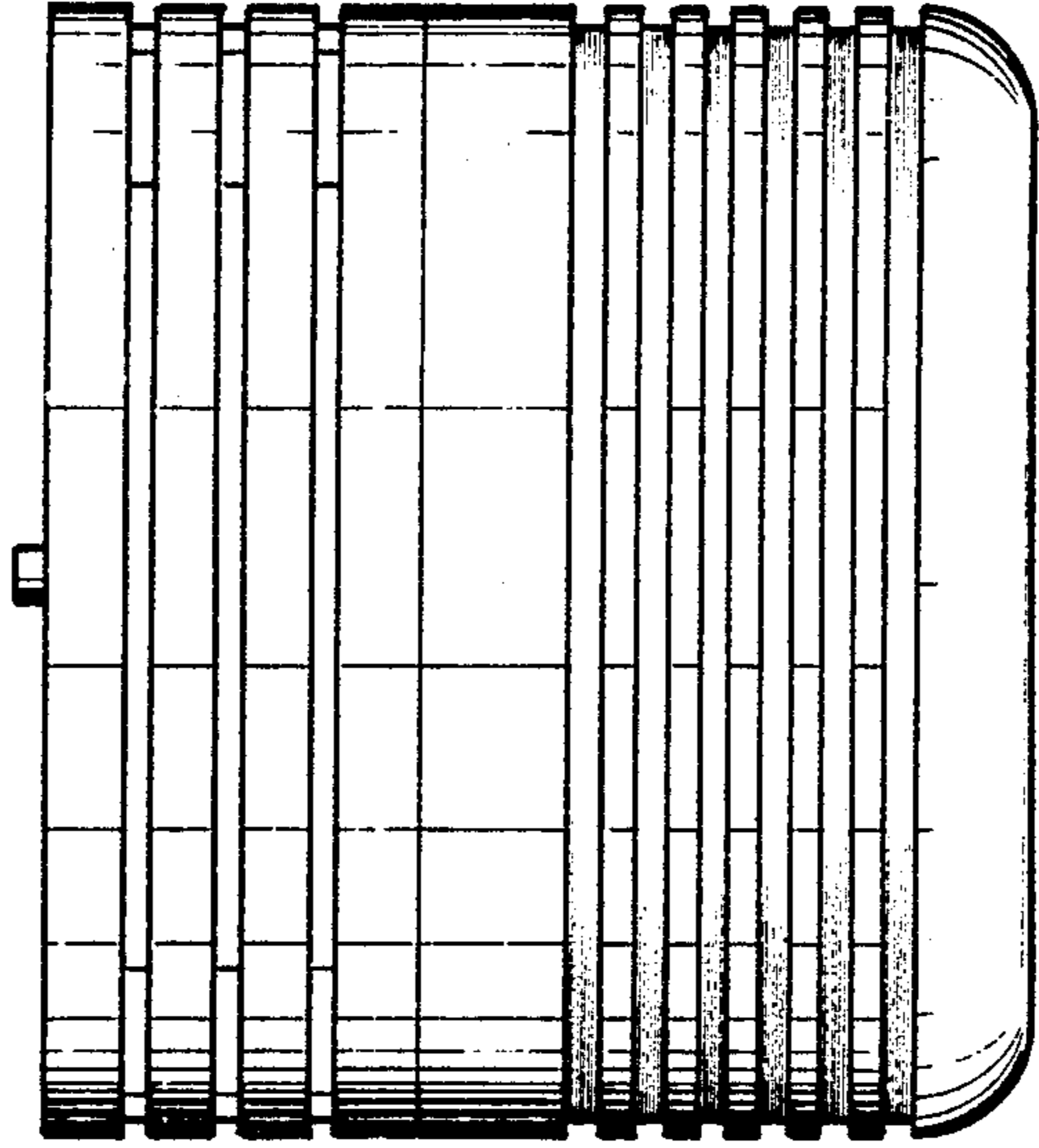

FIG. 3

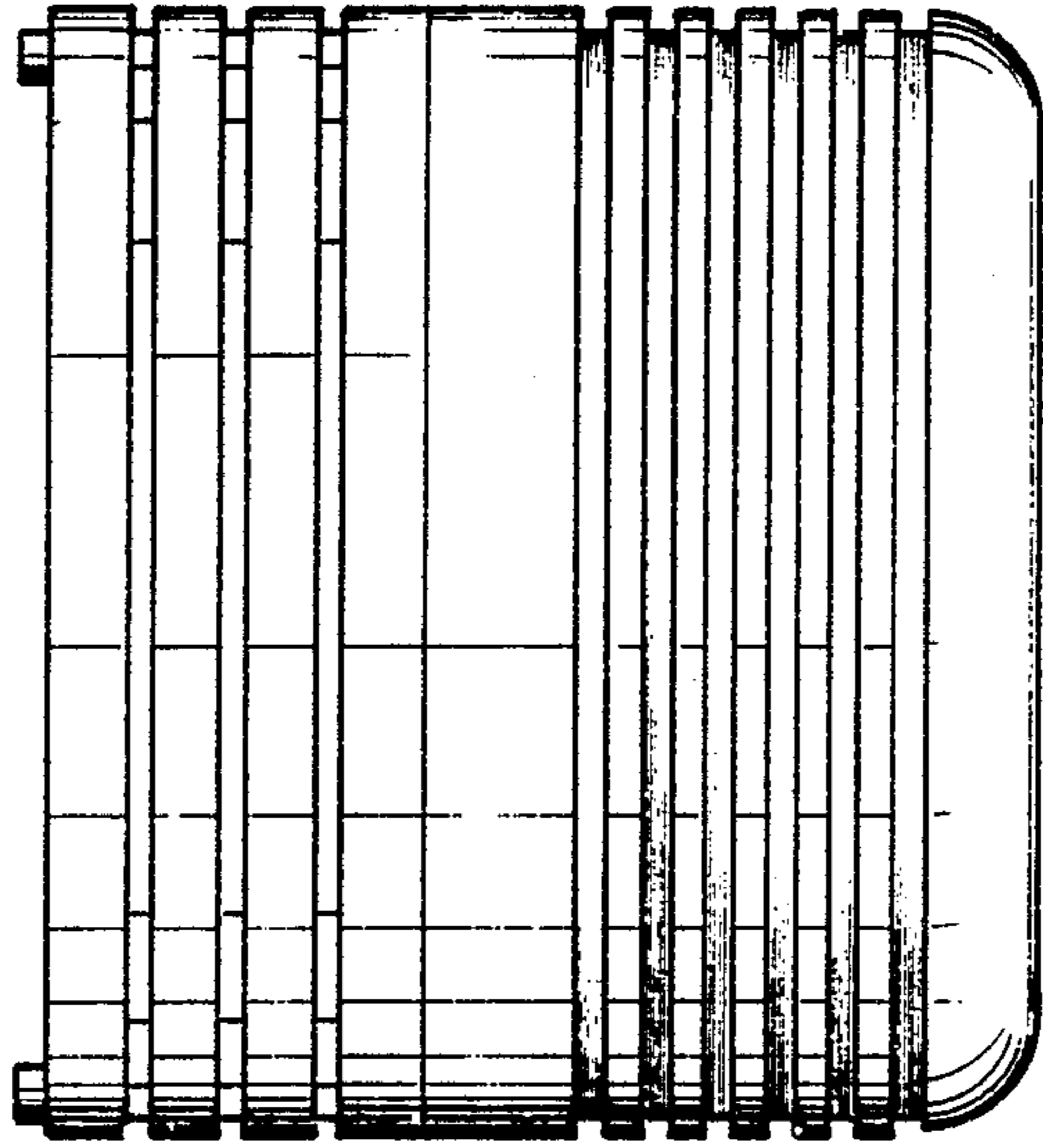

FIG. 2

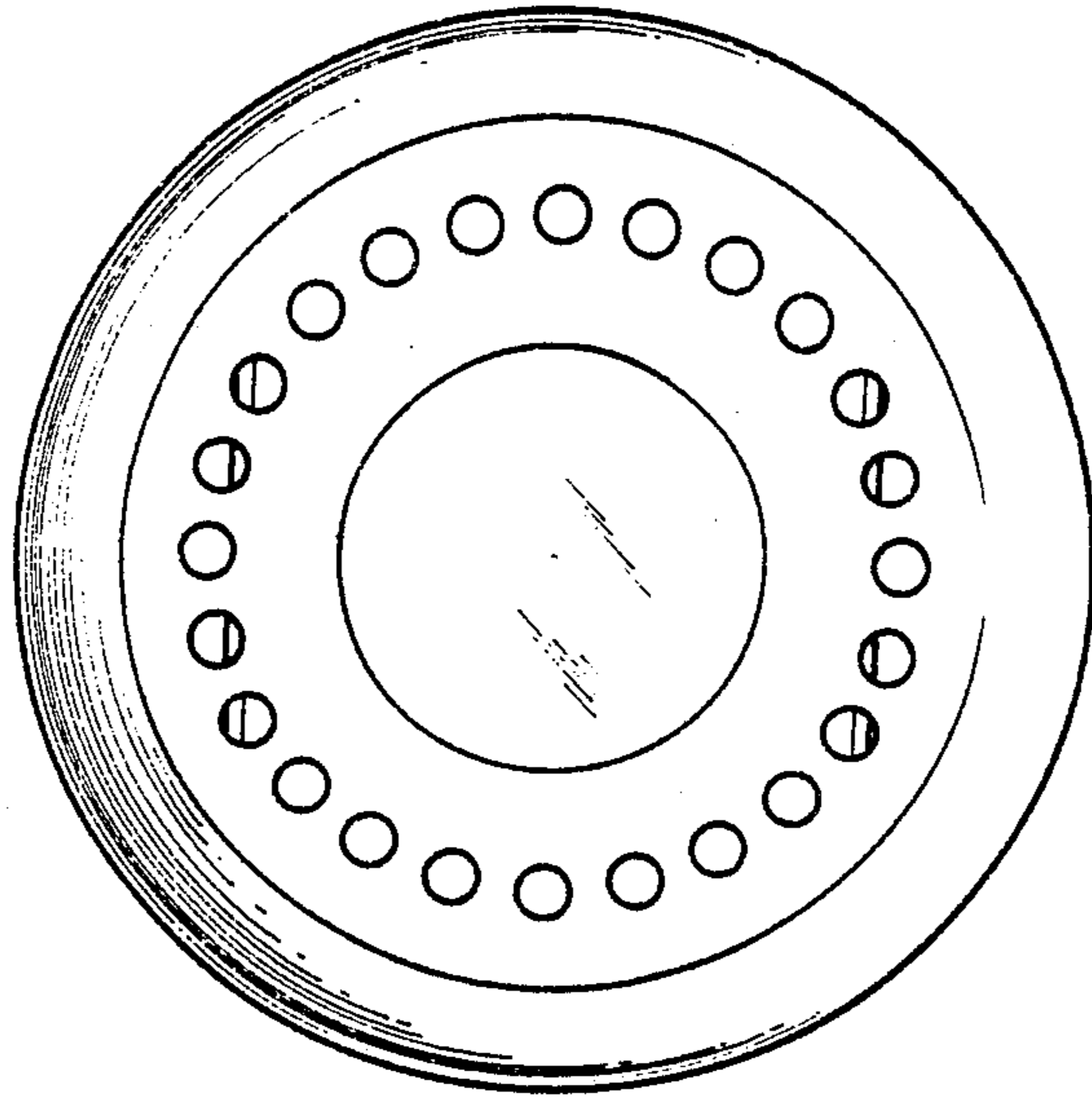

FIG. 5

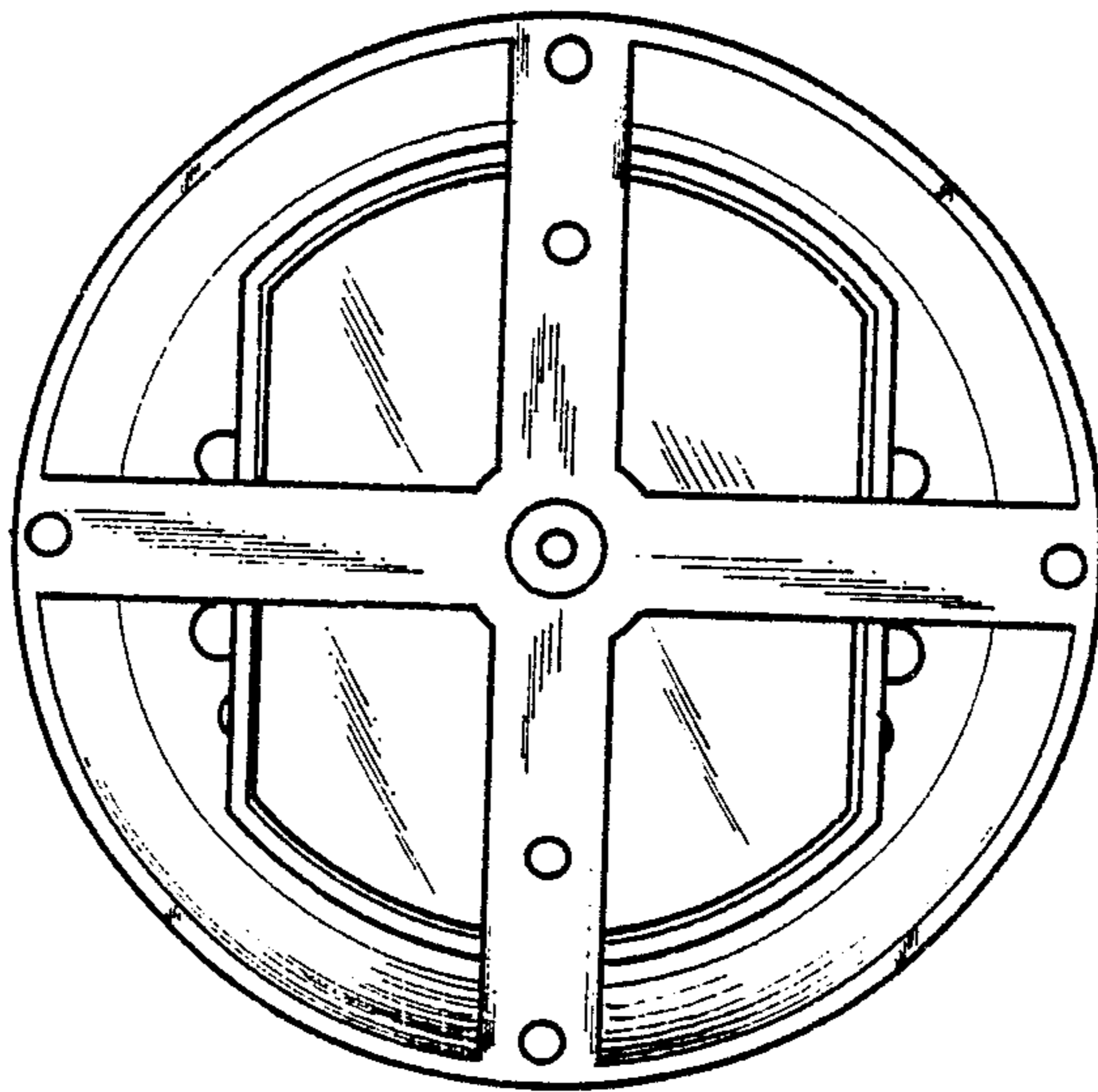

FIG. 4