

[54] FACSIMILE

[75] Inventor: Masaki Takahashi, Kawasaki, Japan

[73] Assignee: Canon Kabushiki Kaisha, Tokyo, Japan

[**] Term: 14 Years

[21] Appl. No.: 197,892

[22] Filed: May 24, 1988

[30] Foreign Application Priority Data

Nov. 27, 1987 [JP] Japan 62-48566

[52] U.S. Cl. D14/118

[58] Field of Search D14/118, 141, 248; D18/36, 37; 358/400, 401

[56] References Cited

U.S. PATENT DOCUMENTS

- D. 299,494 1/1989 Tsuruoka D14/118
- D. 300,139 3/1989 Nishio D14/118

- D. 304,187 10/1989 Komatsu D14/118
- D. 304,578 11/1989 Saegusa et al. D14/118

OTHER PUBLICATIONS

HFD; 06/15/87; p. 76; Center-The FaxLine.

Primary Examiner—Theodore M. Shooman
Attorney, Agent, or Firm—Fitzpatrick, Cella, Harper & Scinto

[57] CLAIM

The ornamental design for a facsimile, as shown.

DESCRIPTION

FIG. 1 is a front elevational view of a facsimile showing my new design;
 FIG. 2 is a rear elevational view thereof;
 FIG. 3 is a top plan view thereof;
 FIG. 4 is a bottom plan view thereof;
 FIG. 5 is a left side elevational view thereof;
 FIG. 6 is a right side elevational view thereof; and
 FIG. 7 is a top and front perspective view thereof.

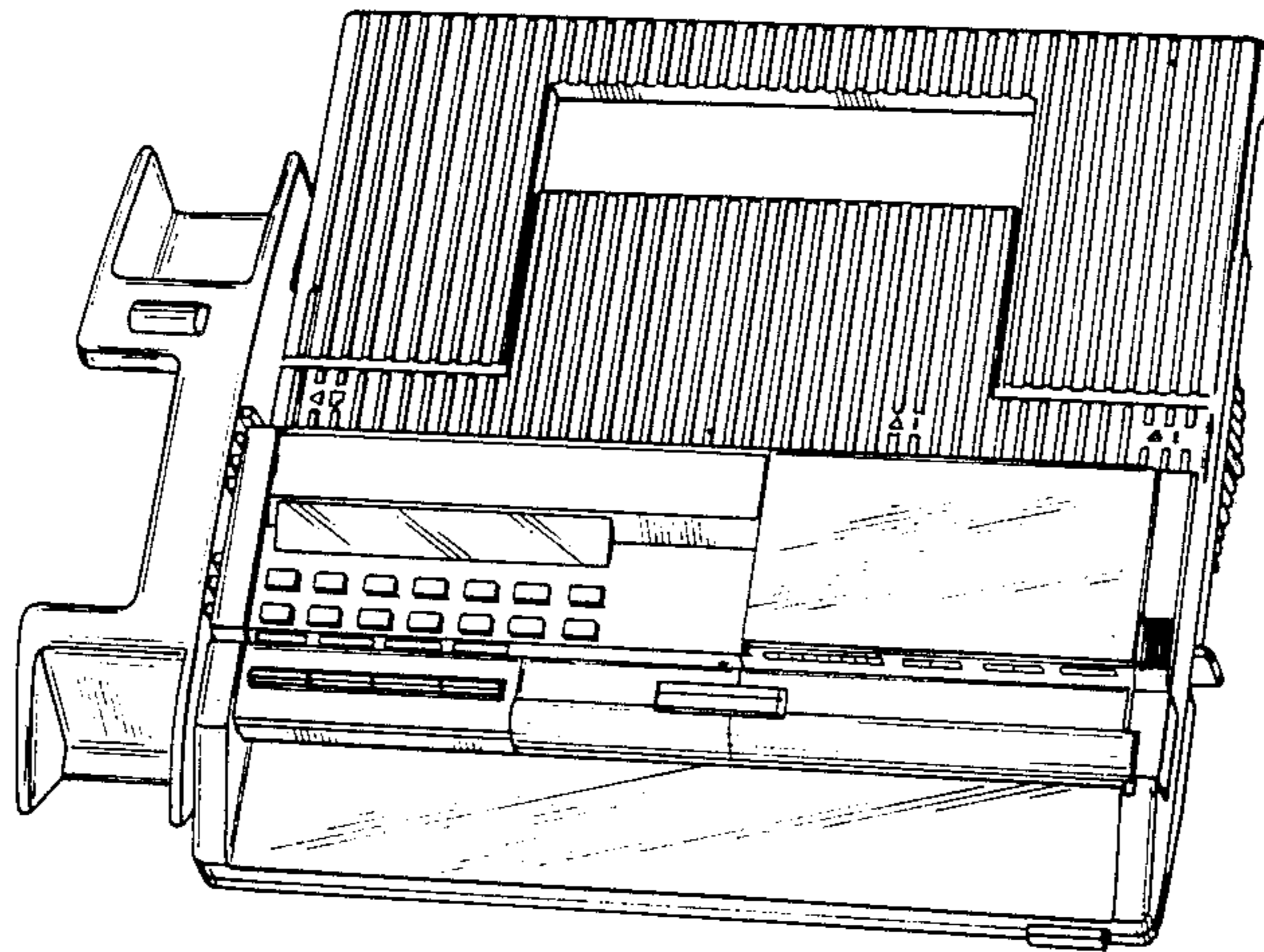

FIG. 1

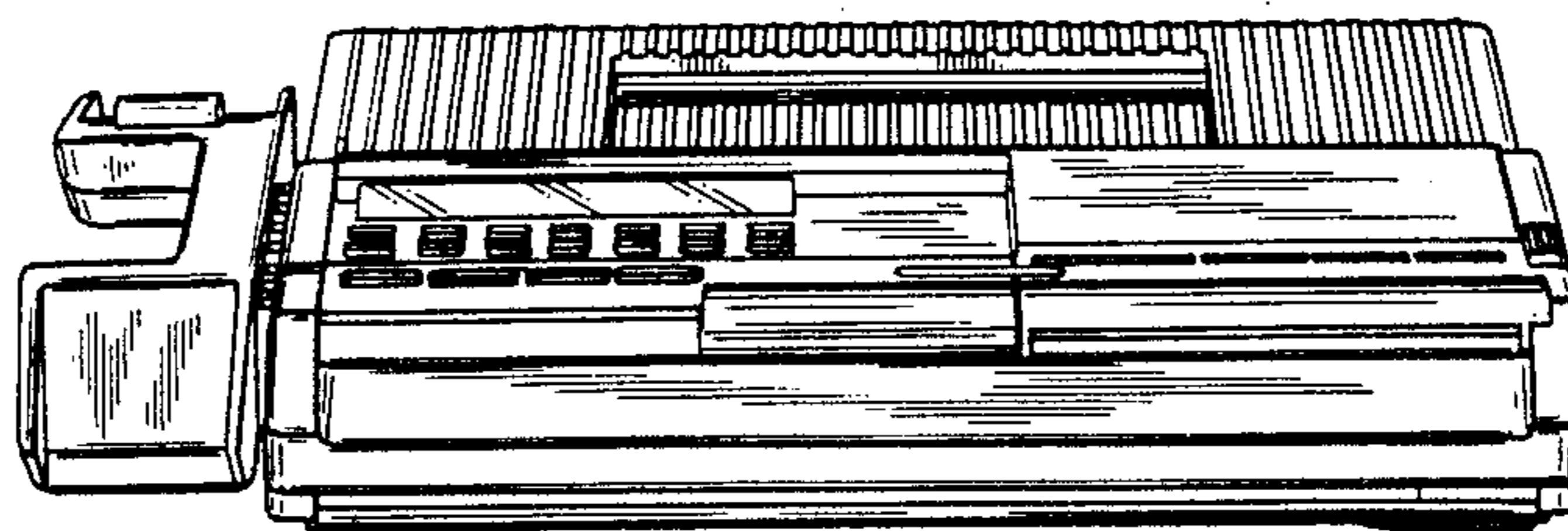

FIG. 2

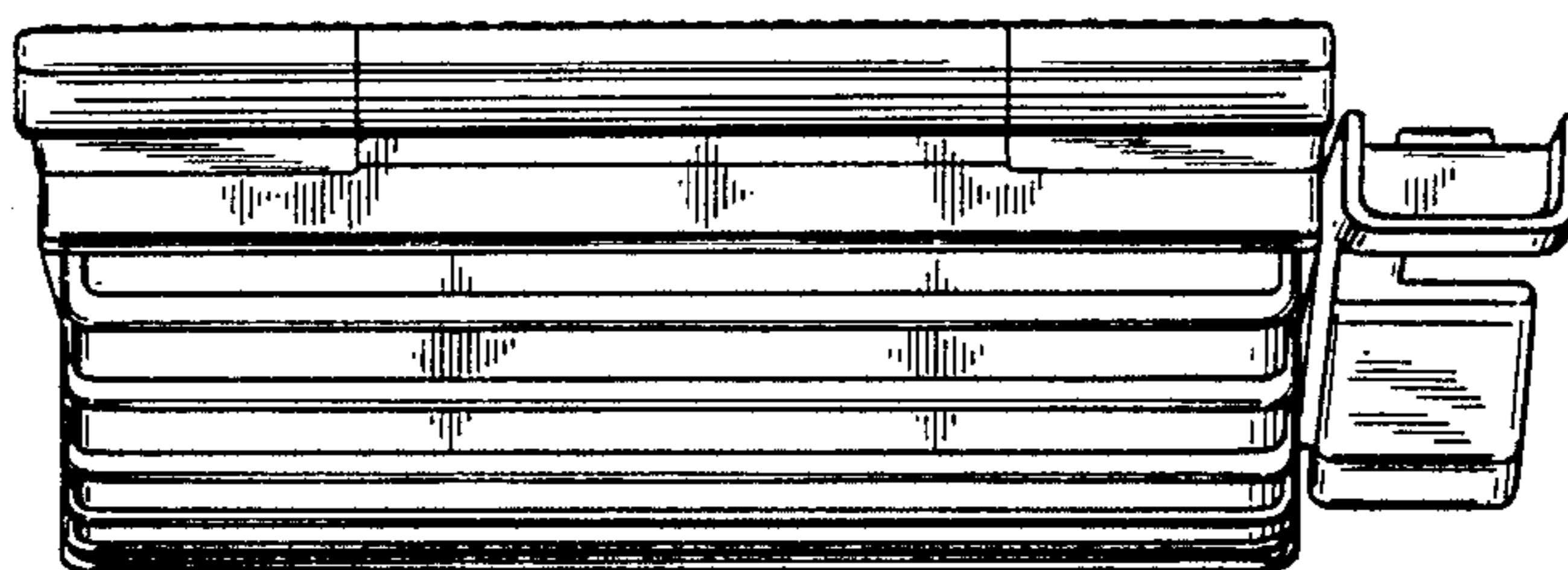

FIG. 3

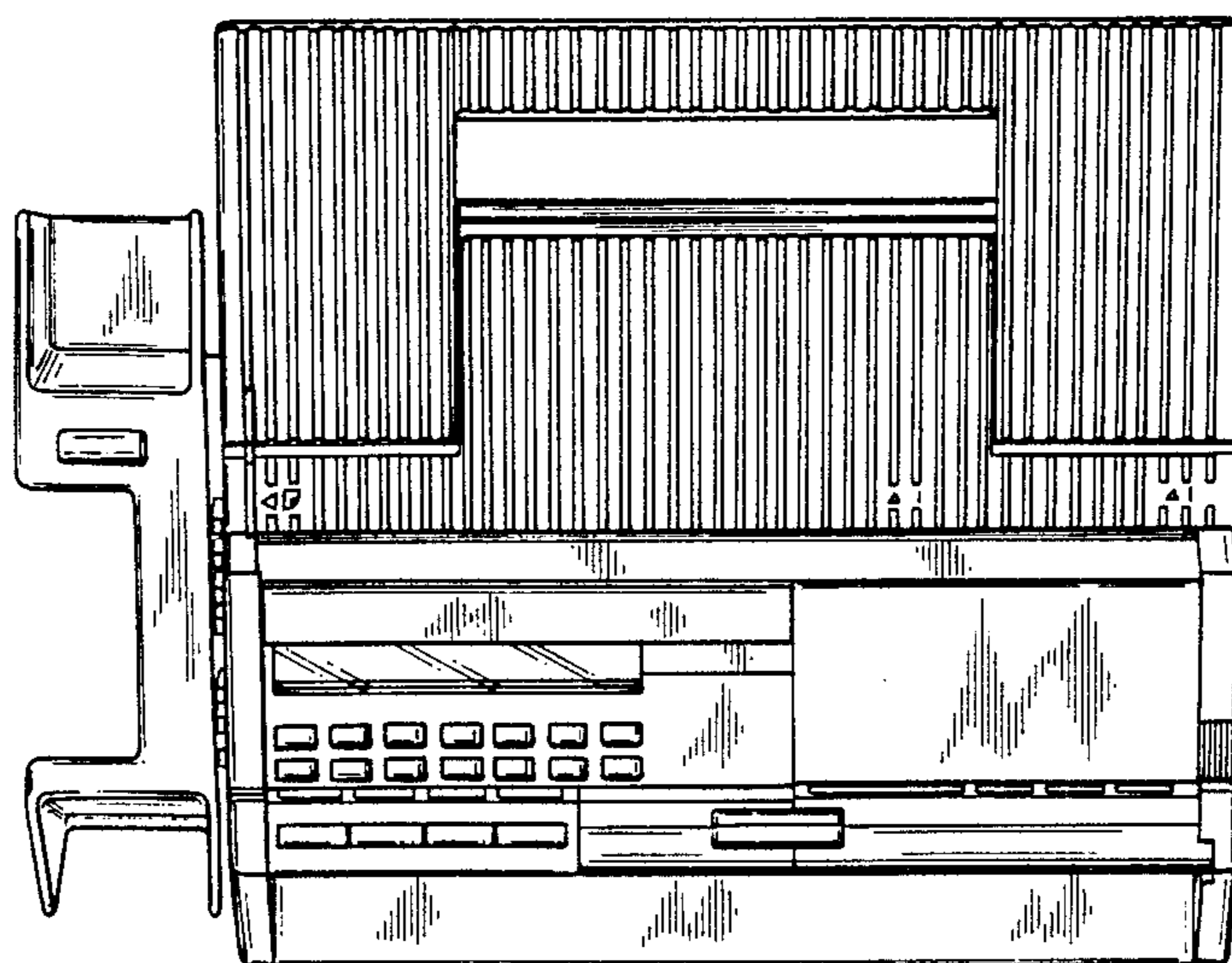

FIG. 4

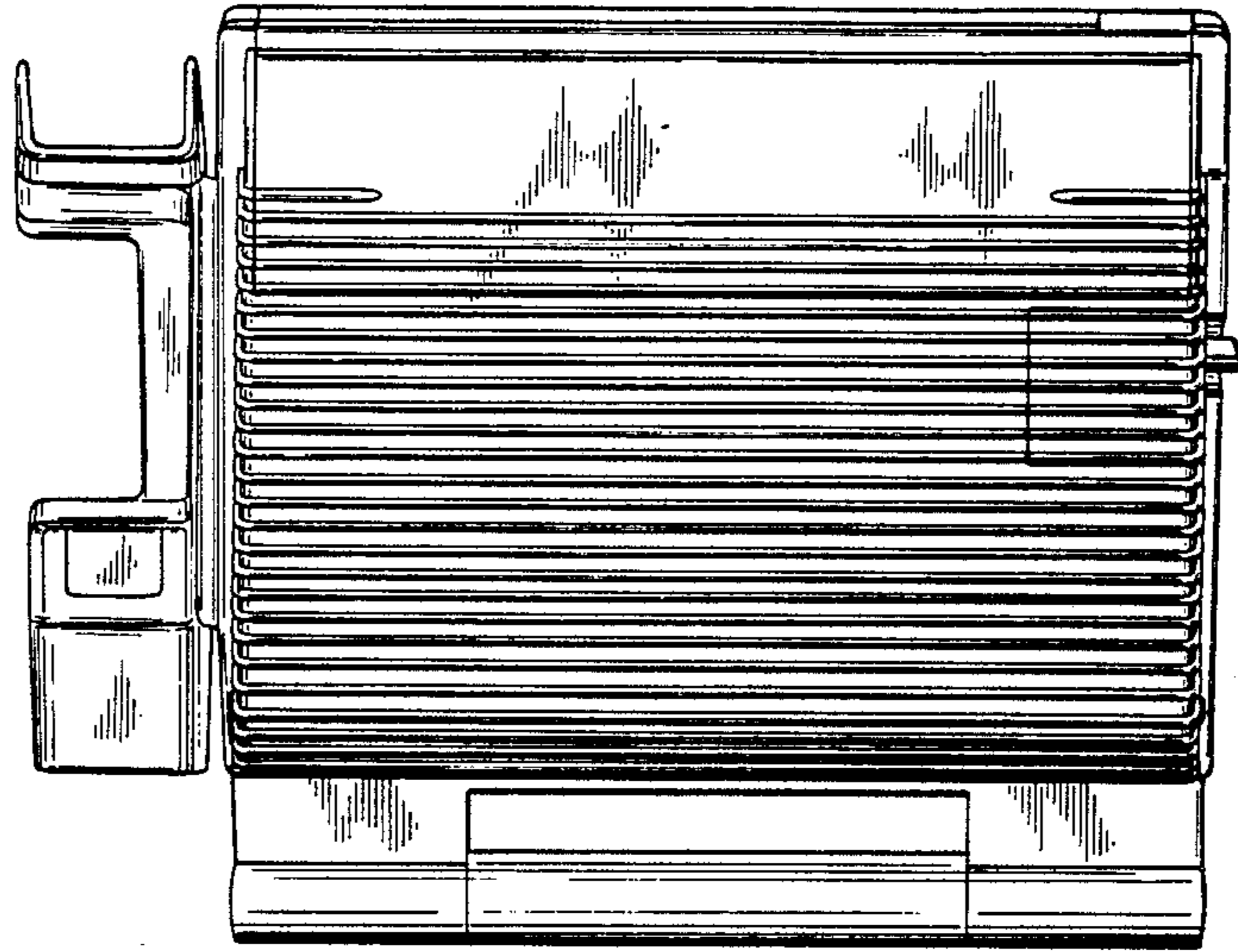

FIG. 5

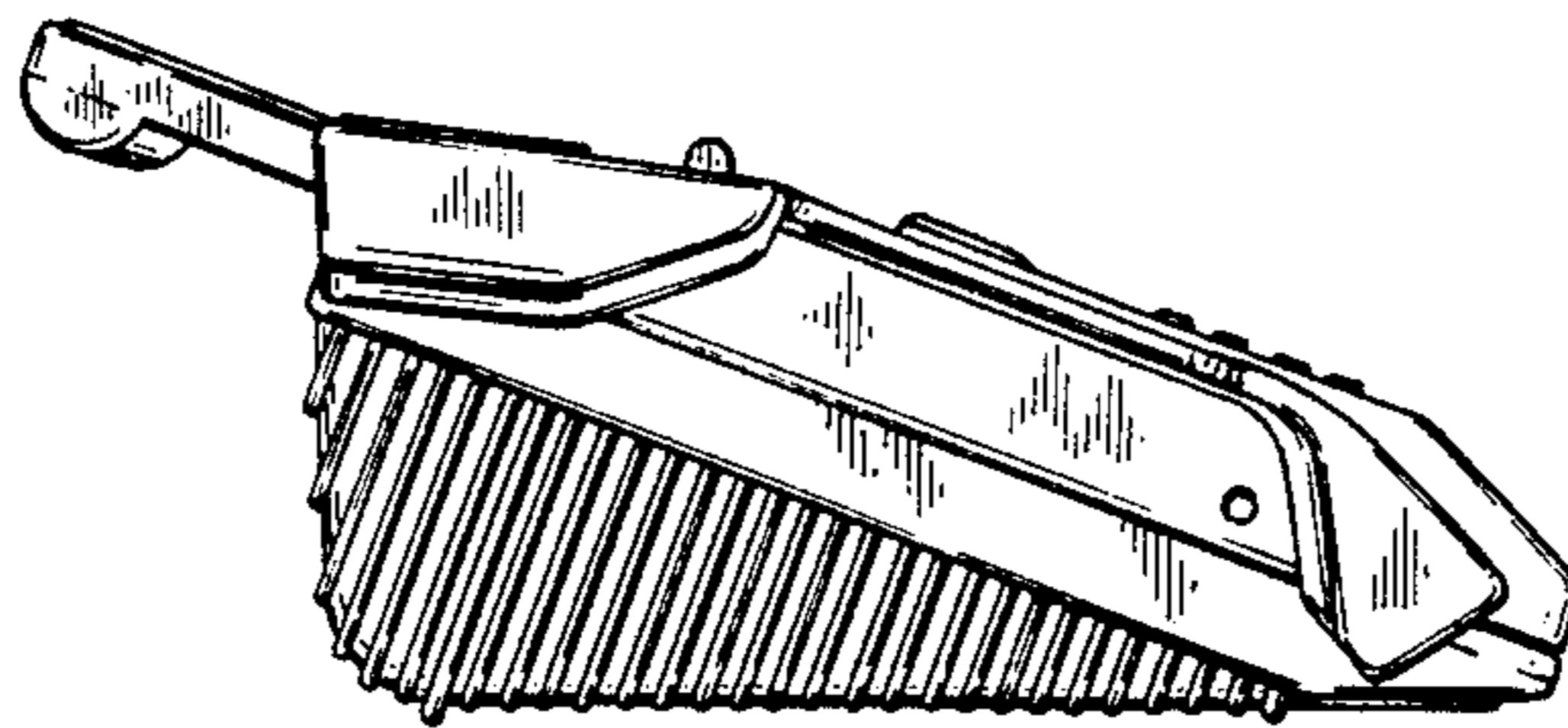

FIG. 6

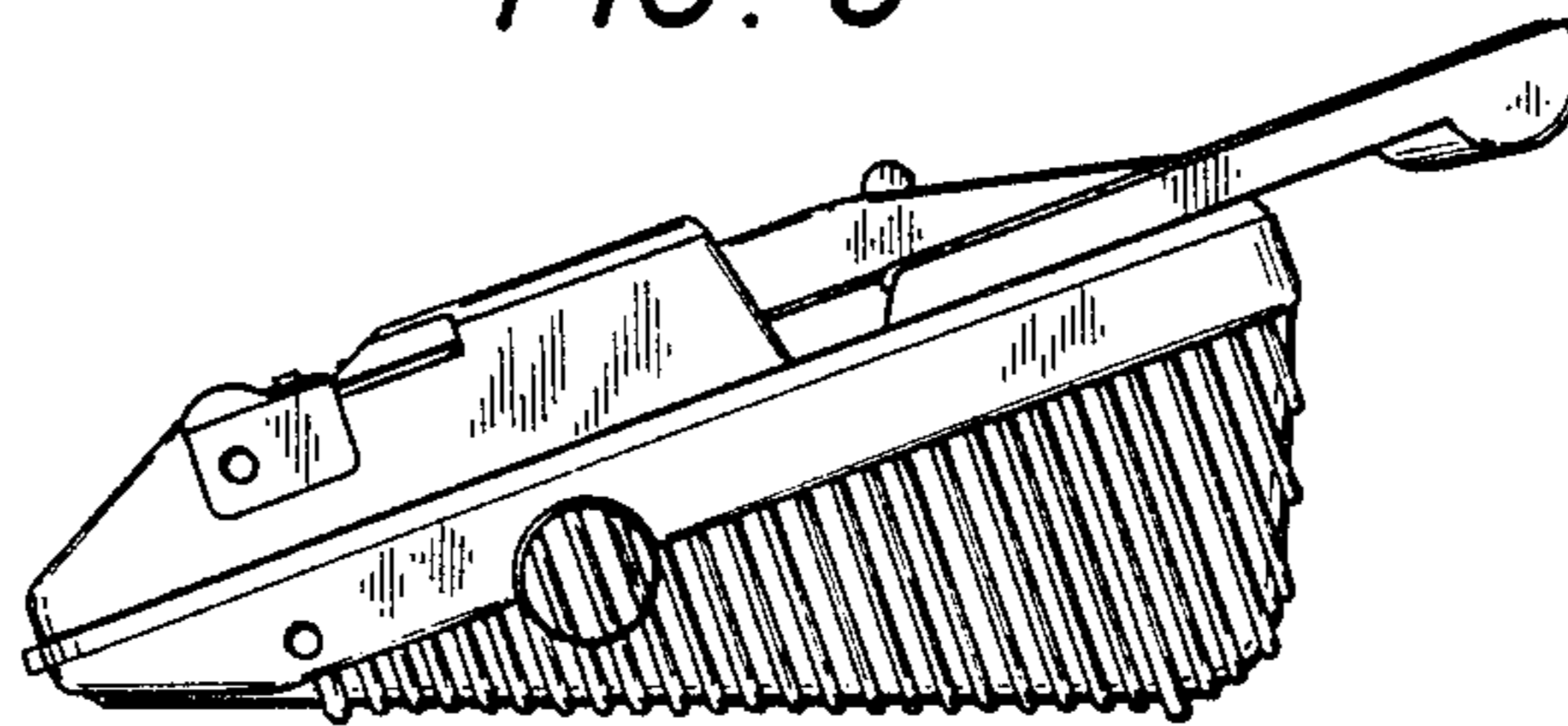

FIG. 7

