

[54] **COMBINED DISPLAY SCREEN BEZEL AND KEYBOARD MOUNTING PANEL**

[75] **Inventor: James J. Kemp, Pleasant Plain, Ohio**

[73] **Assignee: Cincinnati Milacron Inc., Cincinnati, Ohio**

[**] **Term: 14 Years**

[21] **Appl. No.: 118,516**

[22] **Filed: Nov. 6, 1987**

[52] **U.S. Cl. D14/115**

[58] **Field of Search D14/100, 101, 106, 113, D14/115, 239, 124-125; D18/1, 7, 11, 12; 358/249, 254; 364/706-710; 340/700, 706, 711, 712**

[56] **References Cited**

U.S. PATENT DOCUMENTS

- D. 157,635 3/1950 Schnell D14/239
- D. 270,727 9/1983 Gonzales D14/100
- D. 272,348 1/1984 Gonzales et al. D14/100
- D. 277,182 1/1985 Matsuda et al. D14/239

D. 302,428 7/1989 Klebba D14/115

OTHER PUBLICATIONS

Cincinnati Milacron—"Acramatic 850MC Machining Center Control" brochure, Publication No. N-560.

Primary Examiner—Wallace R. Burke

Assistant Examiner—Freda S. Nunn

Attorney, Agent, or Firm—Frost & Jacobs

[57] **CLAIM**

The ornamental design for a combined display screen bezel and keyboard mounting panel, as shown and described.

DESCRIPTION

FIG. 1 is a front elevational view of a combined display screen bezel and keyboard mounting panel showing my new design;

FIG. 2 is a top plan view thereof;

FIG. 3 is a bottom plan view thereof;

FIG. 4 is a right side elevational view thereof;

FIG. 5 is a rear elevational view thereof;

FIG. 6 is a left side elevational view thereof; and

FIG. 7 is a perspective view thereof.

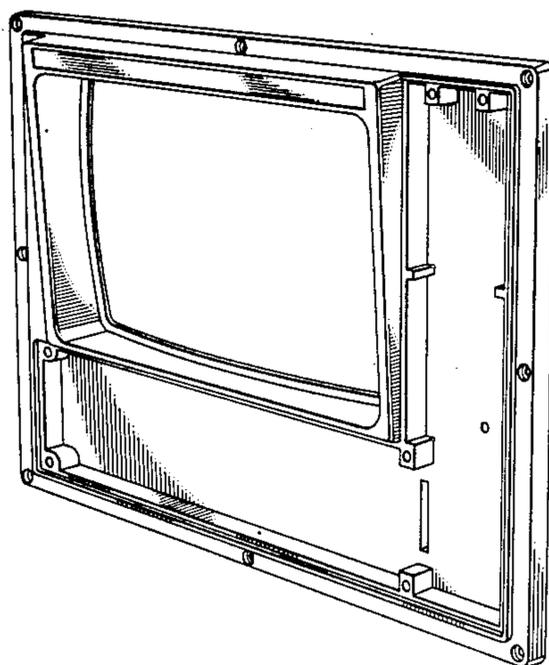

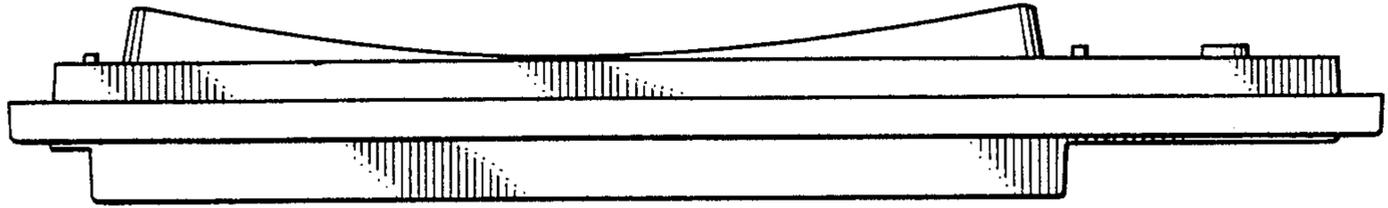

FIG. 2

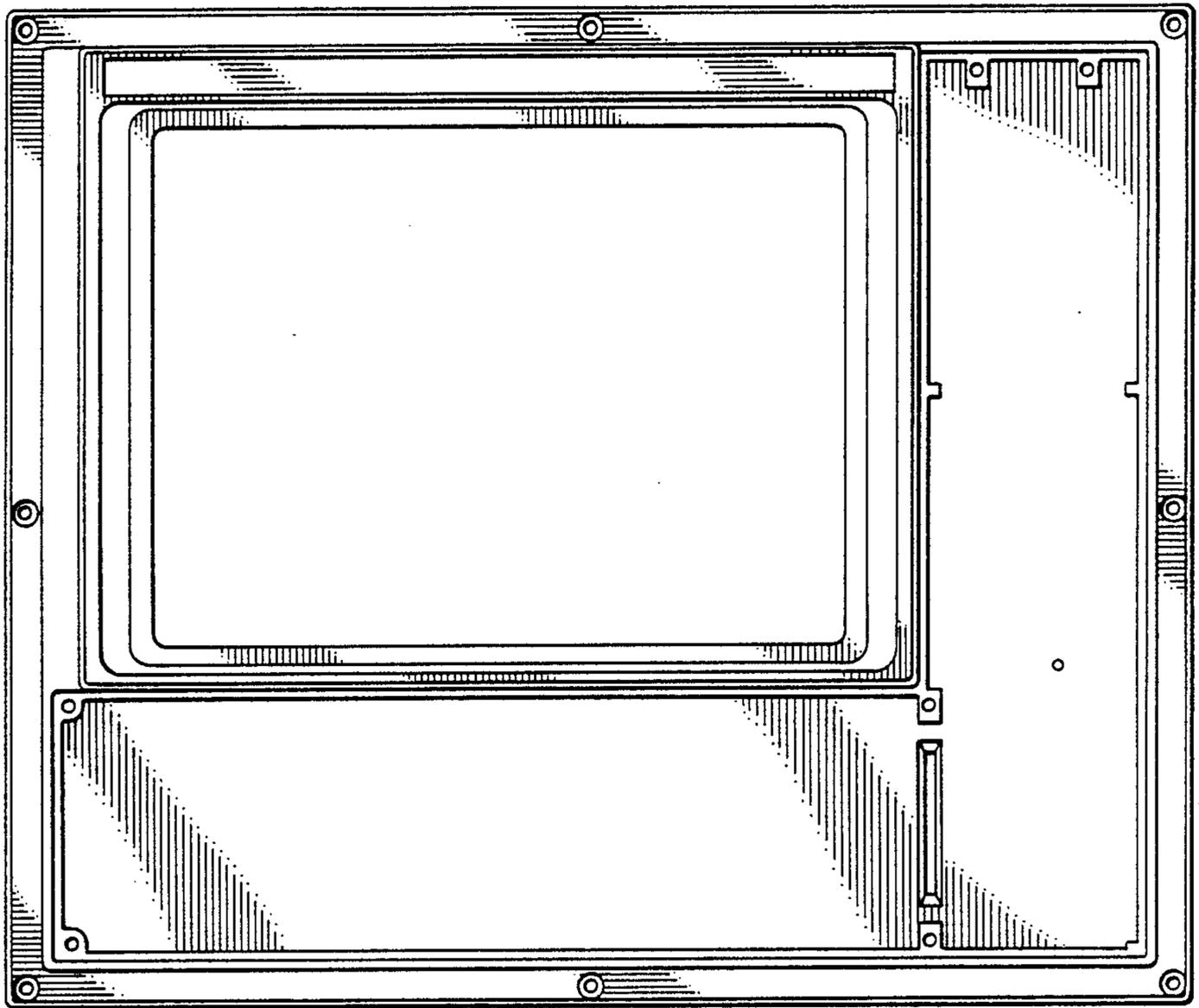

FIG. 1

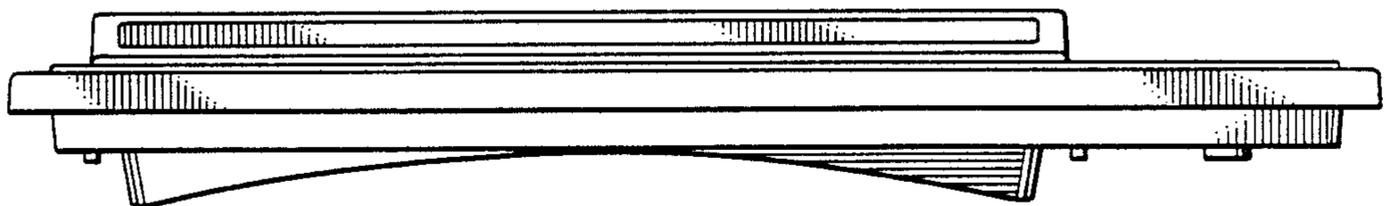

FIG. 3

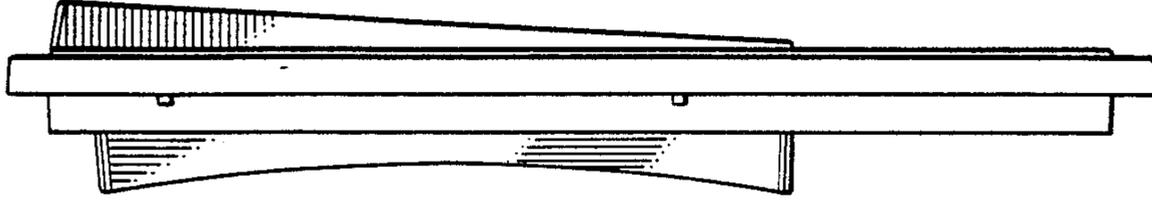

FIG. 6

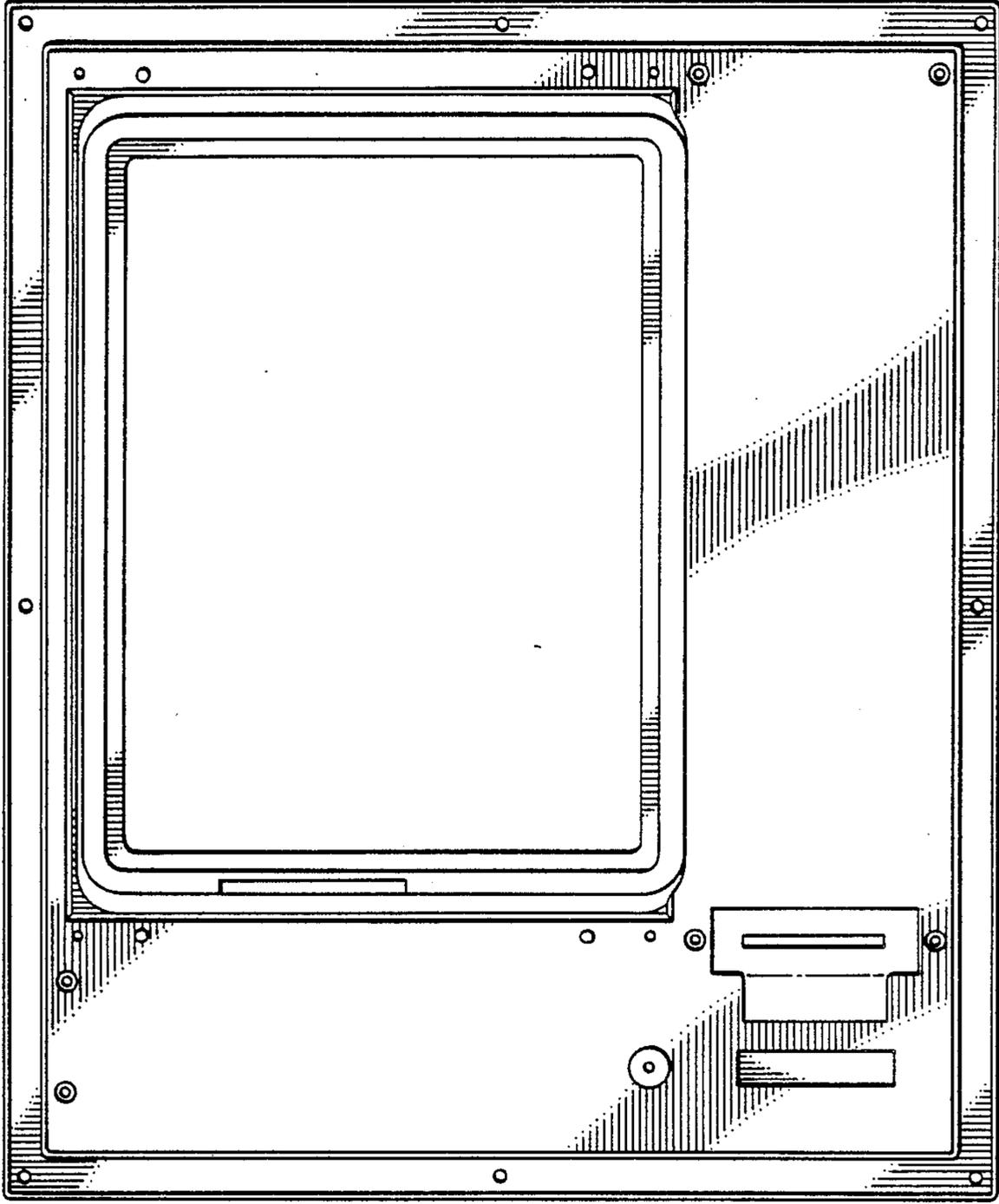

FIG. 5

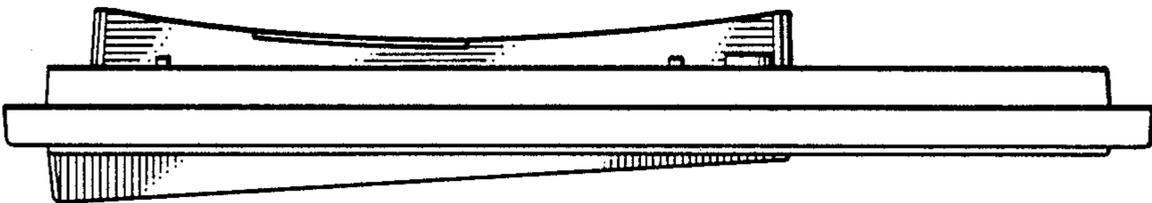

FIG. 4

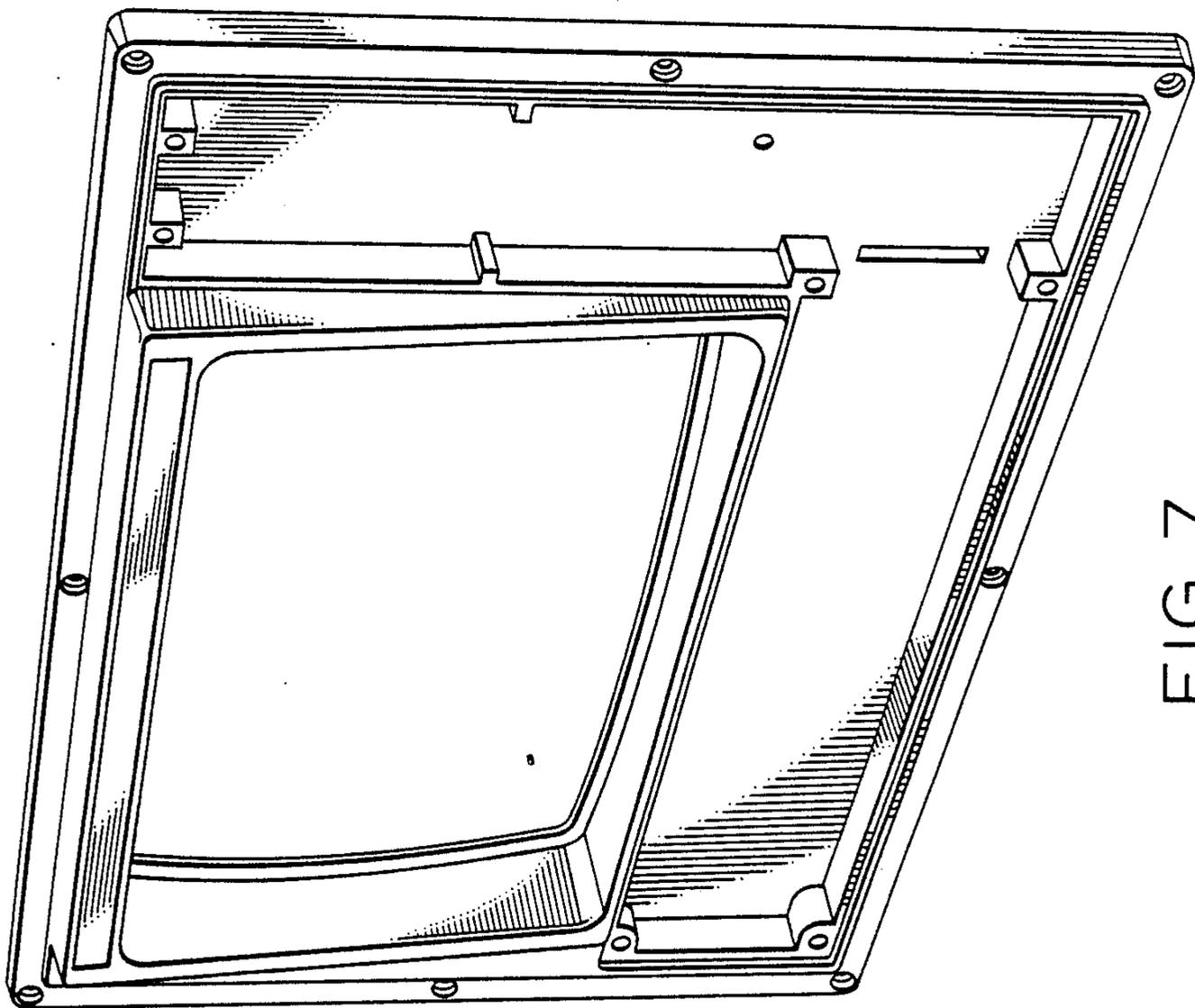

FIG. 7