

[54] BOX ENCLOSURE FOR TRUCKS

[76] Inventor: Robert Karrer, P.O. Box 3183,
Smithers, British Columbia, Canada,
VOJ 2N0

[**] Term: 14 Years

[21] Appl. No.: 24,333

[22] Filed: Mar. 10, 1987

[52] U.S. Cl. D12/156

[58] Field of Search D12/156; 296/3, 10,
296/98, 99.1, 100

[56] References Cited

U.S. PATENT DOCUMENTS

D. 235,327	6/1975	Morris	D12/156
D. 263,947	4/1982	Hardin	D12/156
3,489,456	1/1970	Klanke	296/100
4,615,557	10/1986	Robinson	296/102

Primary Examiner—James M. Gandy
Attorney, Agent, or Firm—Bauer & Schaffer

[57] CLAIM

The ornamental design for a box enclosure for trucks, as shown and described.

DESCRIPTION

FIG. 1 is a perspective view of the top, rear and one side of a box enclosure for trucks showing my new design;

FIG. 2 is a disc elevation view thereof;

FIG. 3 is a rear elevation view thereof;

FIG. 4 is a front elevation view thereof;

FIG. 5 is a top plan view thereof; and

FIG. 6 is a perspective view of the top, rear and opposite side thereof on a reduced scale it being understood that the broken lines are for illustrative purpose only and form no part of the claimed design.

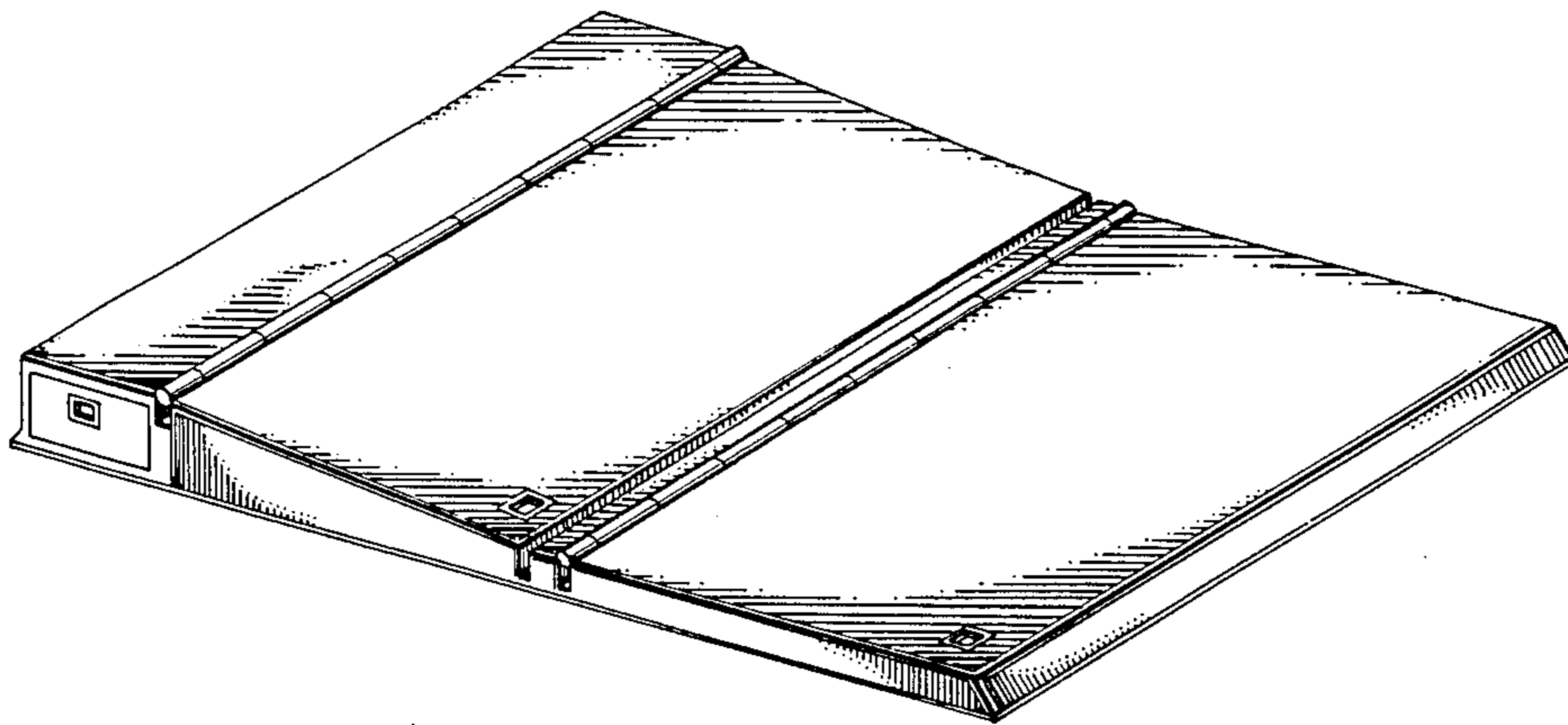

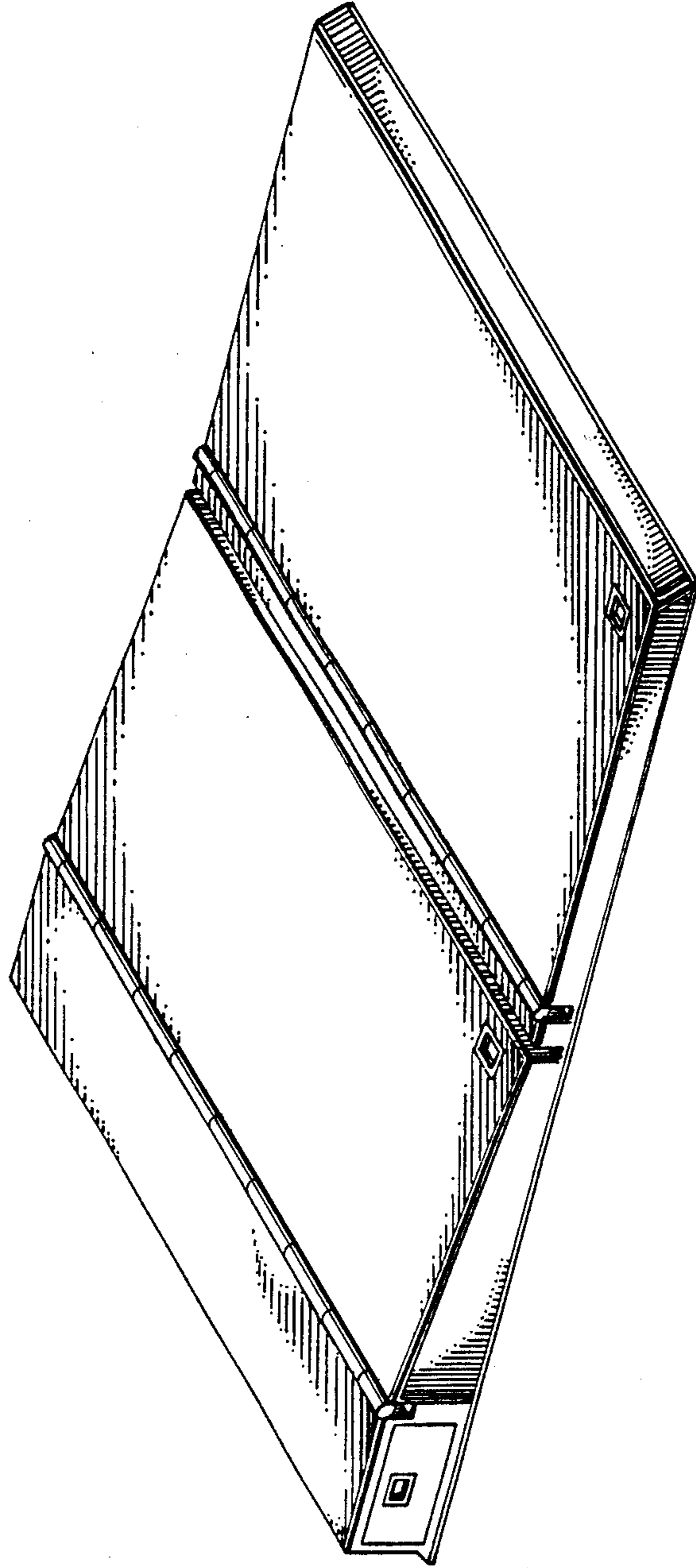

FIG. 1

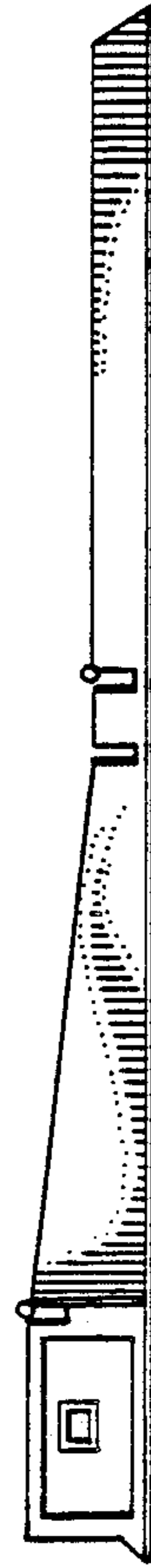

FIG. 2

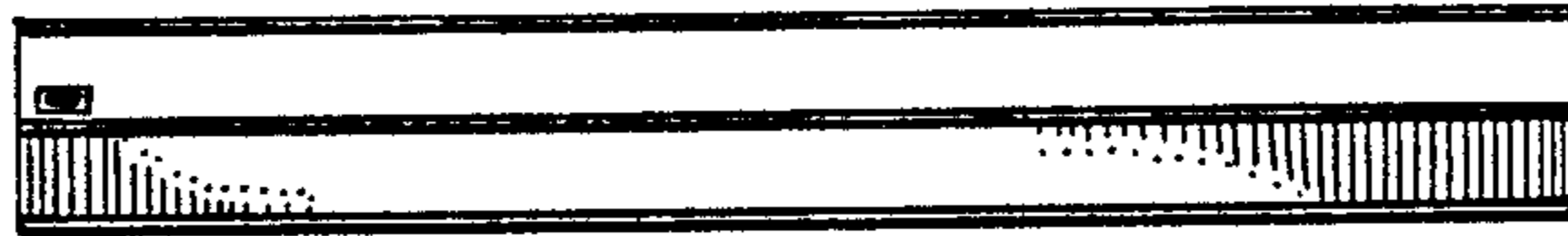

FIG. 3

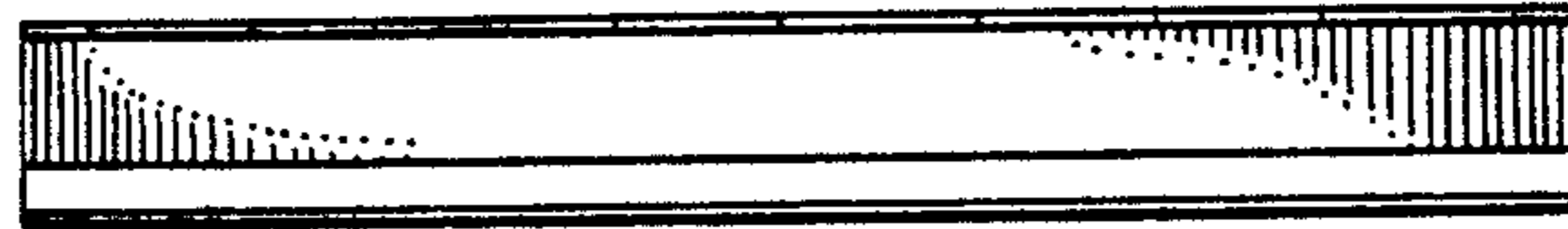

FIG. 4

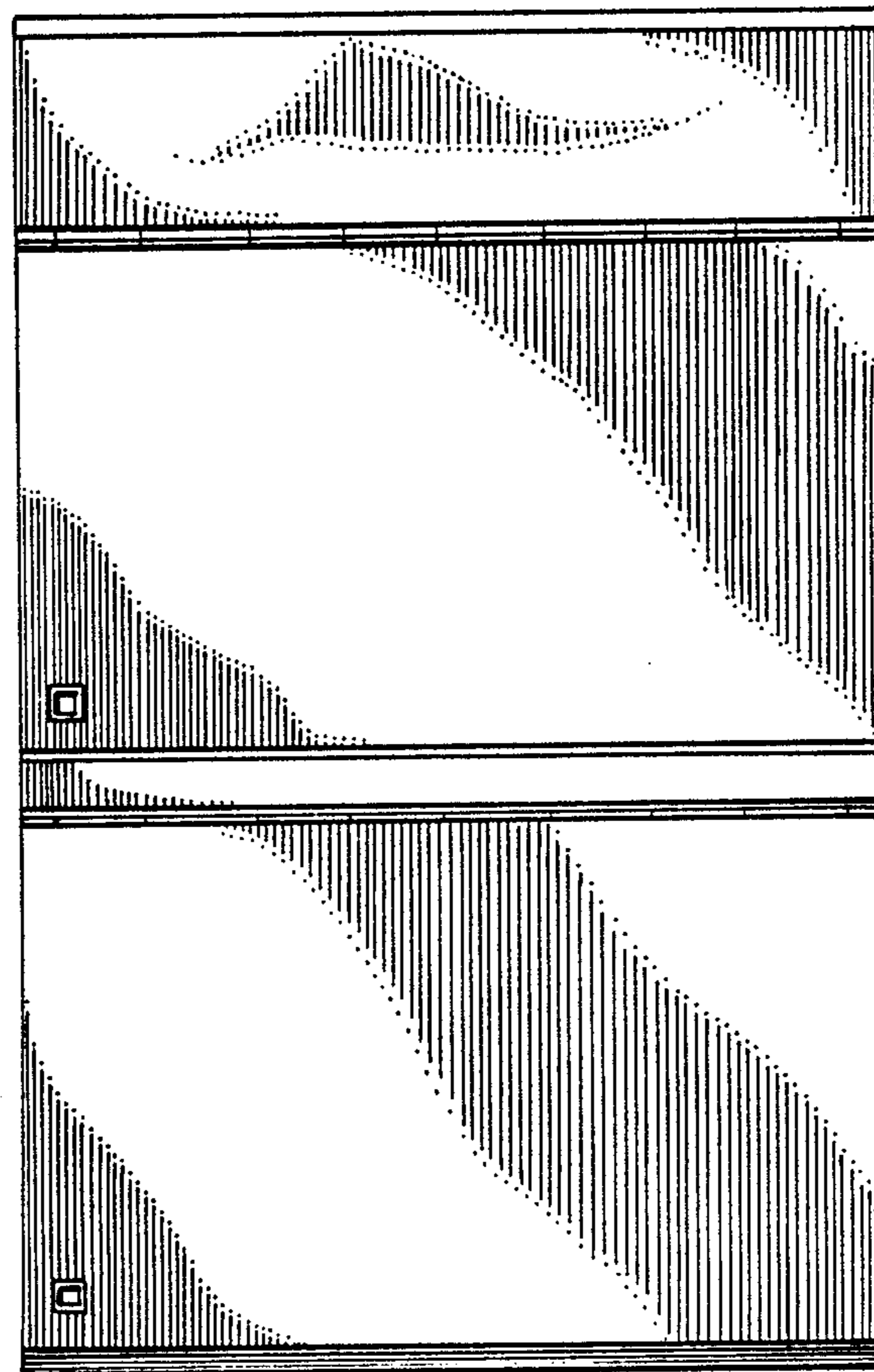

FIG. 5

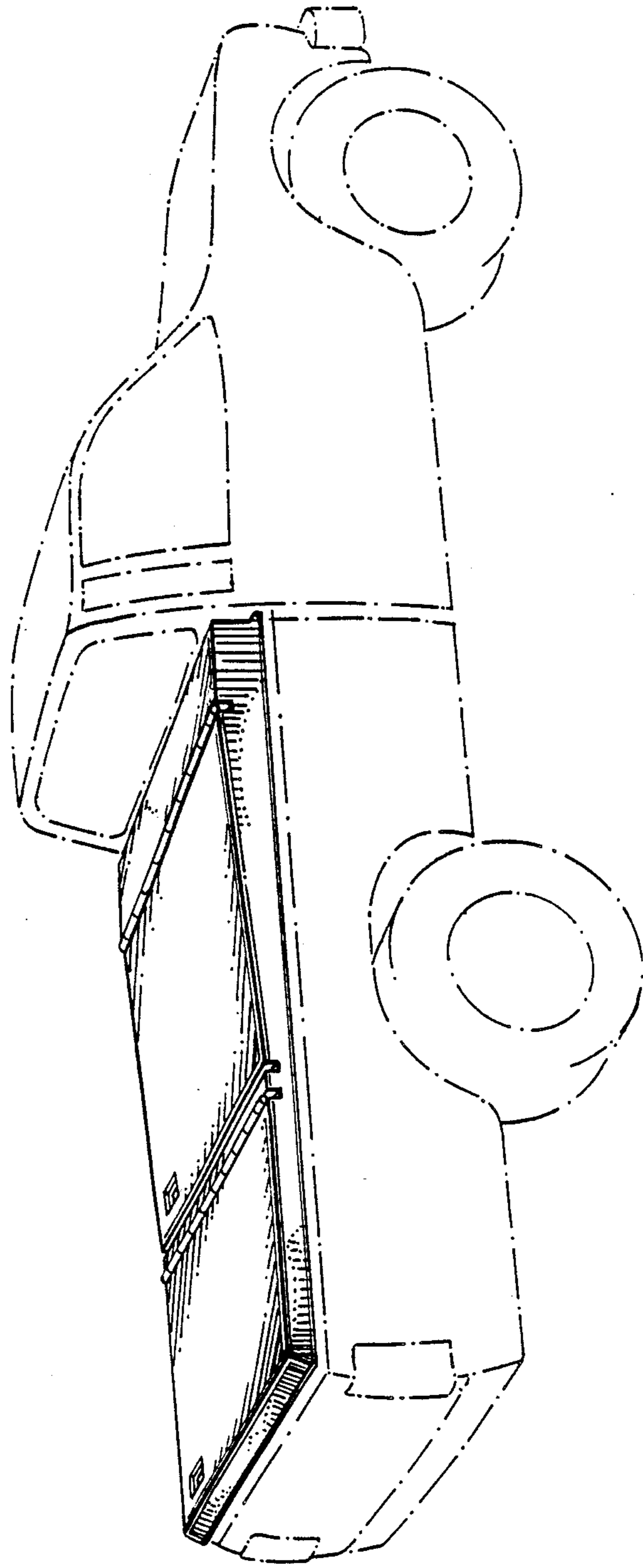

FIG. 6