

[54] **SIGN HOLDER**

[75] **Inventor: William E. Adams, Portersville, Pa.**

[73] **Assignee: Adams Mfg., Portersville, Pa.**

[**] **Term: 14 Years**

[21] **Appl. No.: 54,816**

[22] **Filed: May 28, 1987**

[52] **U.S. Cl. D20/43**

[58] **Field of Search D20/42, 43, 99, 10; D19/52; D8/388, 391; D11/202, 204, 205, 222, 223, 224, 230, 231; 40/591, 597, 593, 606, 642-644, 658, 662; 248/466, 467, 205.8, 206.2-206.4, 309.2, 309.3, 363**

[56] **References Cited**

U.S. PATENT DOCUMENTS

D. 133,663	9/1942	Beason	D20/43
D. 206,786	1/1967	McCormick	D20/43
D. 286,612	11/1986	Adams	D8/391
1,797,220	3/1931	Brock	40/642 X
1,800,218	4/1931	Janda	40/597 X
2,045,672	6/1936	Oliveri	248/467 X
2,277,981	3/1942	Horton	40/597 X
3,007,435	11/1961	Peterson	40/597 X
3,148,856	9/1964	Orlando	40/597 X

3,254,435	6/1966	Rix	40/593
3,300,173	1/1967	Kennedy, Jr.	248/467
4,607,875	8/1986	McGirr	248/205.9 X

OTHER PUBLICATIONS

Copy of Specification and drawings for U.S. patent application Ser. No. 806,191, filed Nov. 22, 1985.

Primary Examiner—Wallace R. Burke

Assistant Examiner—Joel Sincavage

Attorney, Agent, or Firm—Buchanan Ingersoll

[57] **CLAIM**

The ornamental design for a sign holder, as shown and described.

DESCRIPTION

FIG. 1 is a front elevational view of a sign holder showing my new design;
 FIG. 2 is a back elevational view thereof;
 FIG. 3 is a top plan view thereof;
 FIG. 4 is a bottom plan view thereof;
 FIG. 5 is a side elevational view thereof, the opposite side being a mirror image;
 FIG. 6 is a perspective view thereof; and
 FIG. 7 is an exploded perspective view thereof with a sign shown in broken lines for illustrative purposes.

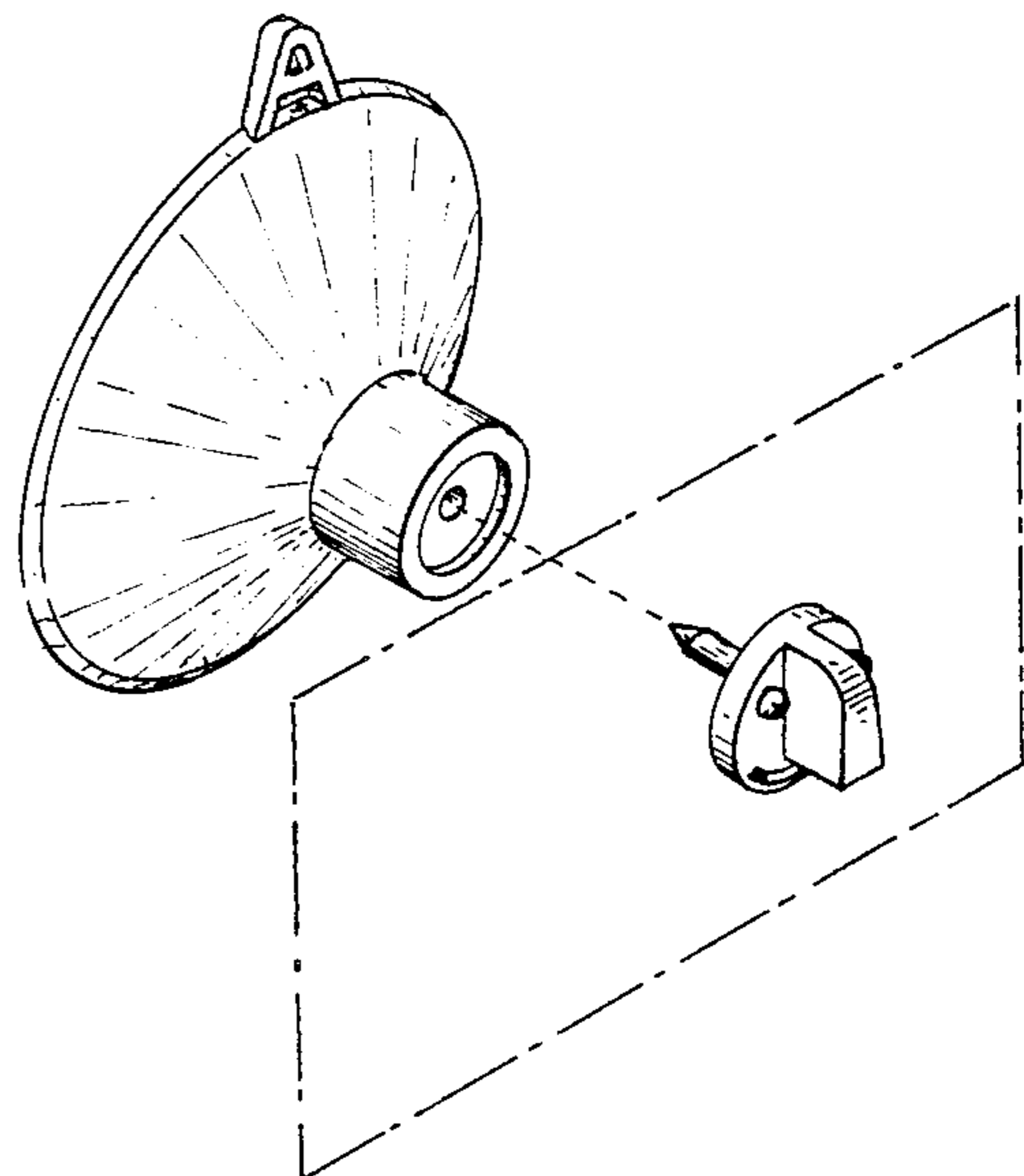
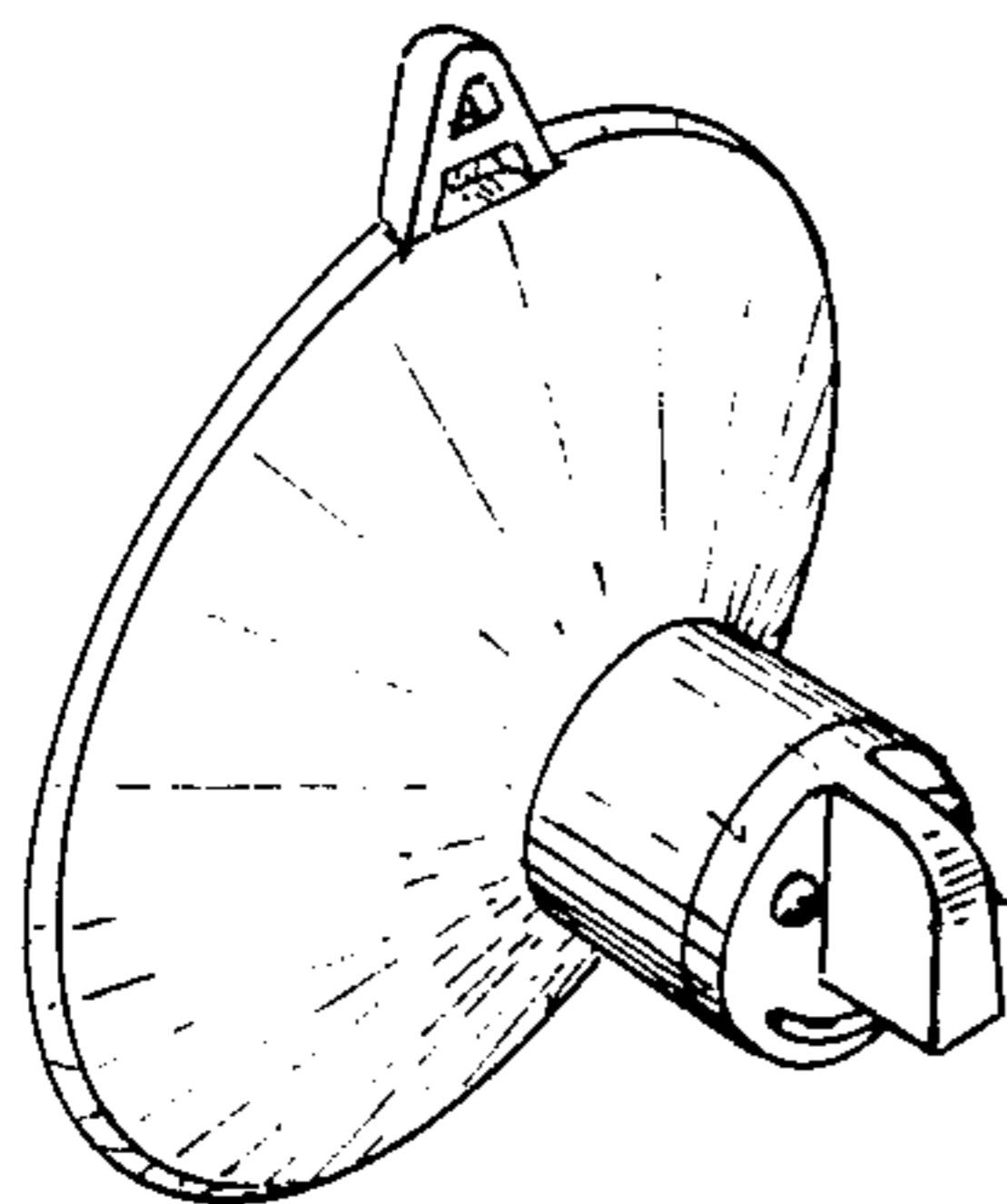

Fig. 1.

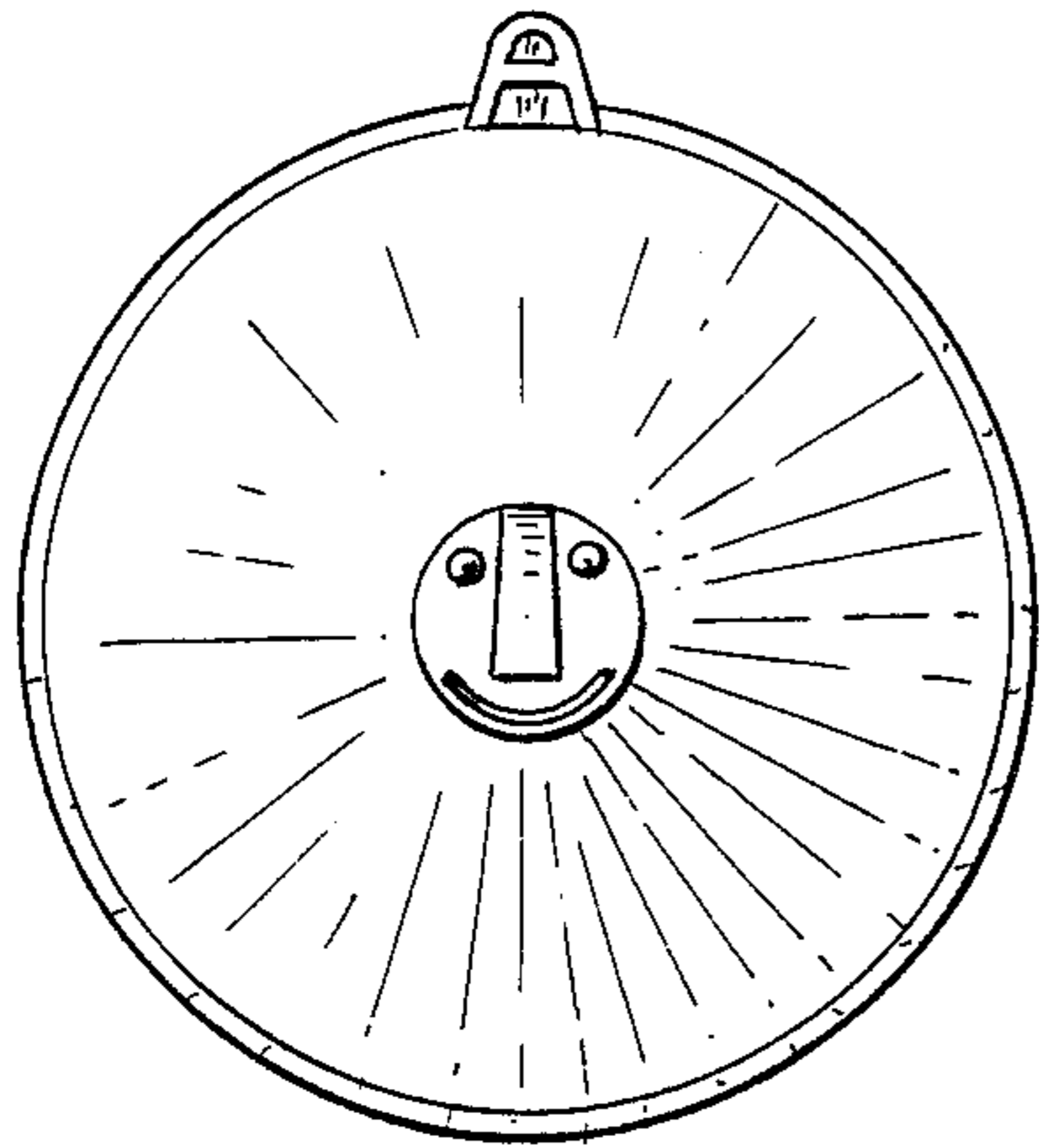

Fig. 2.

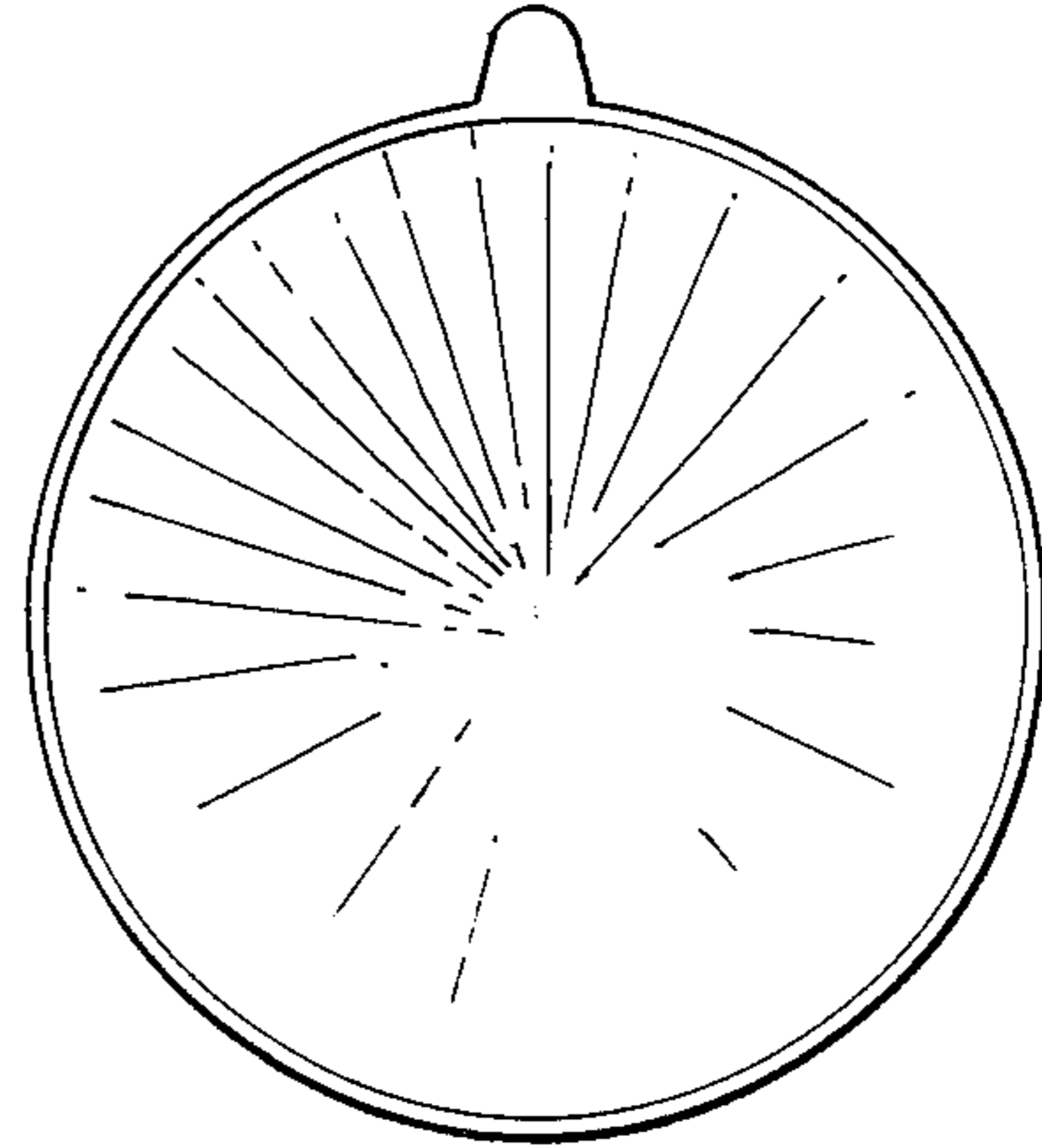

Fig. 3.

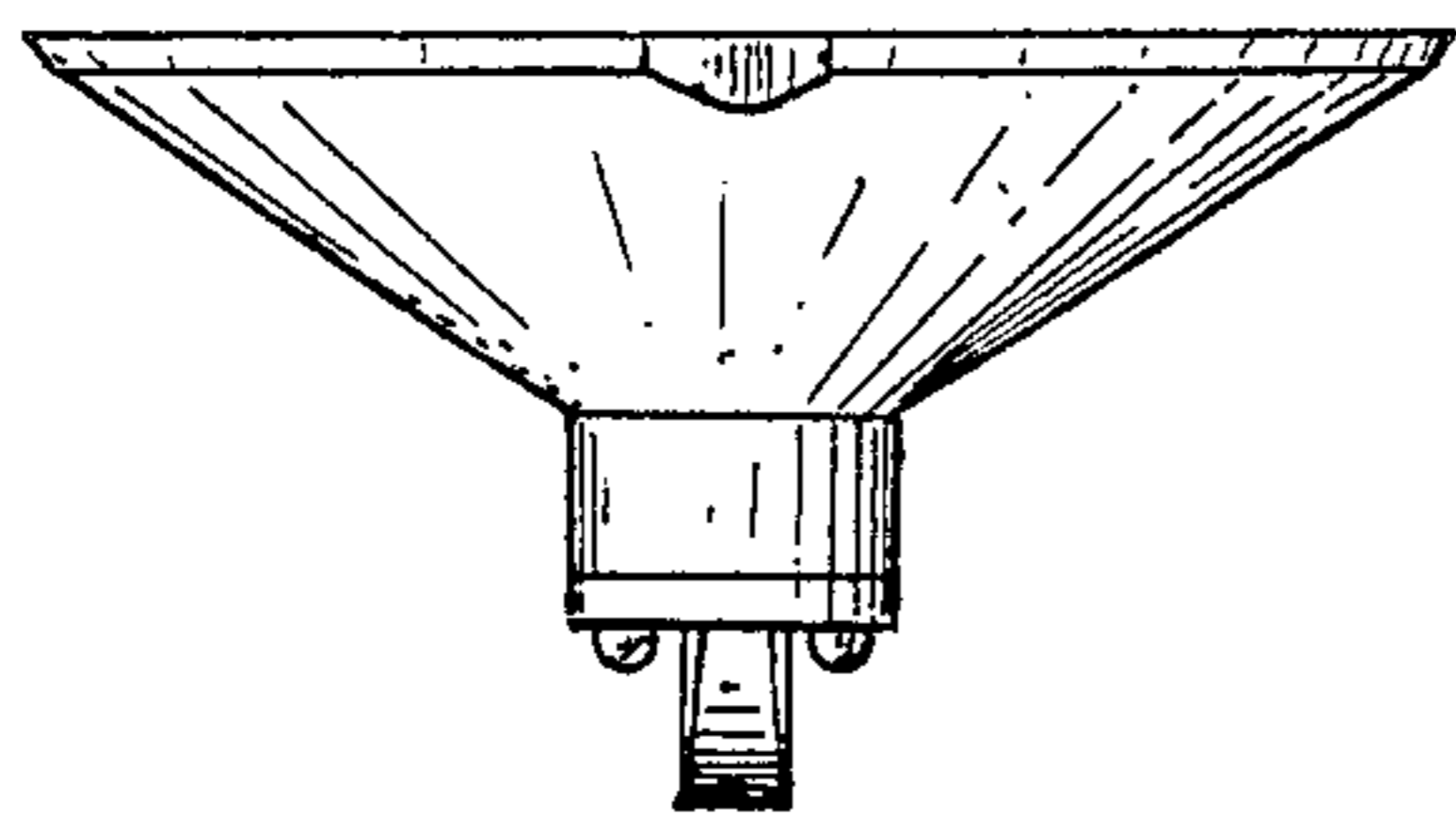

Fig. 5.

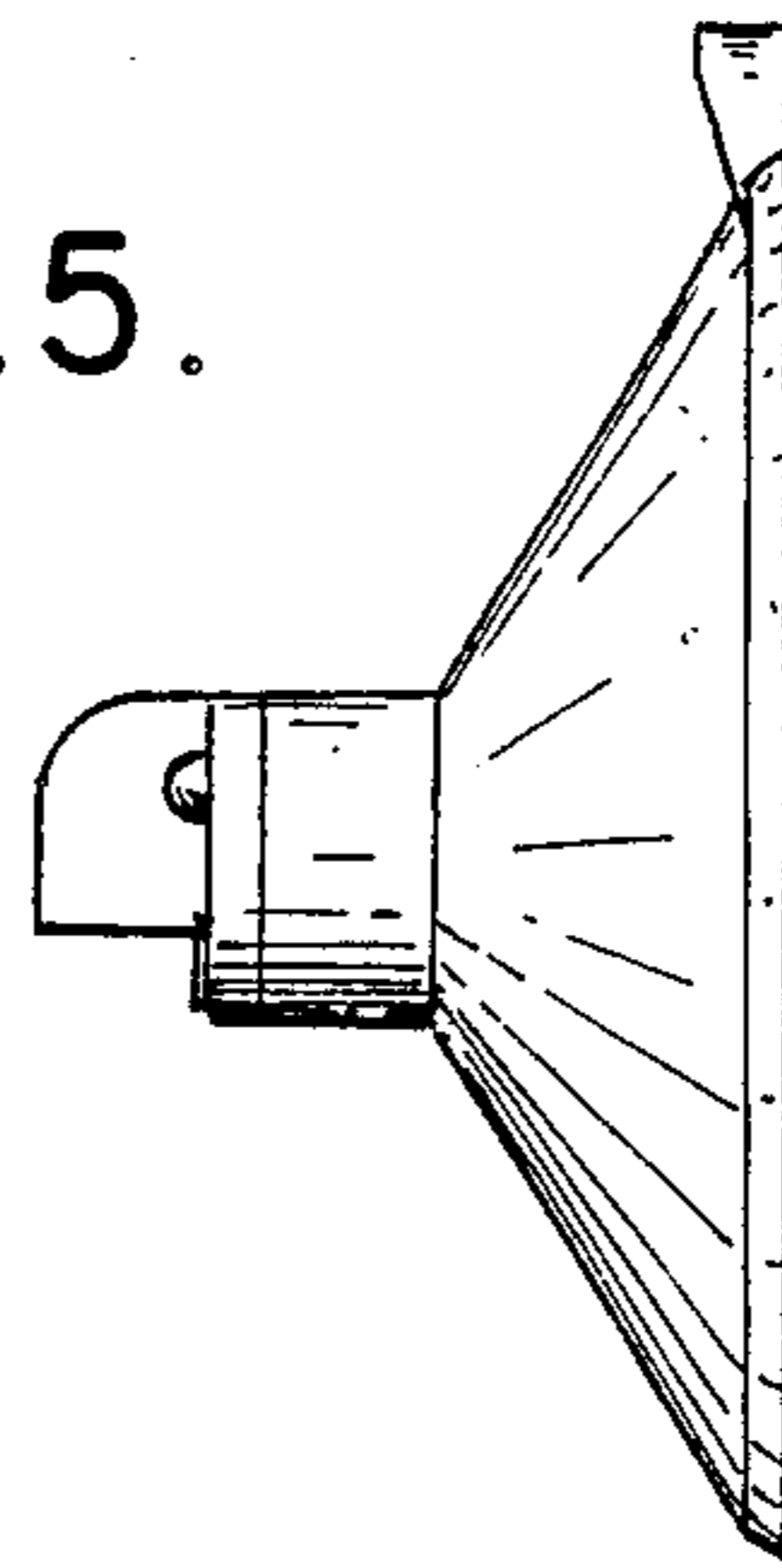

Fig. 4.

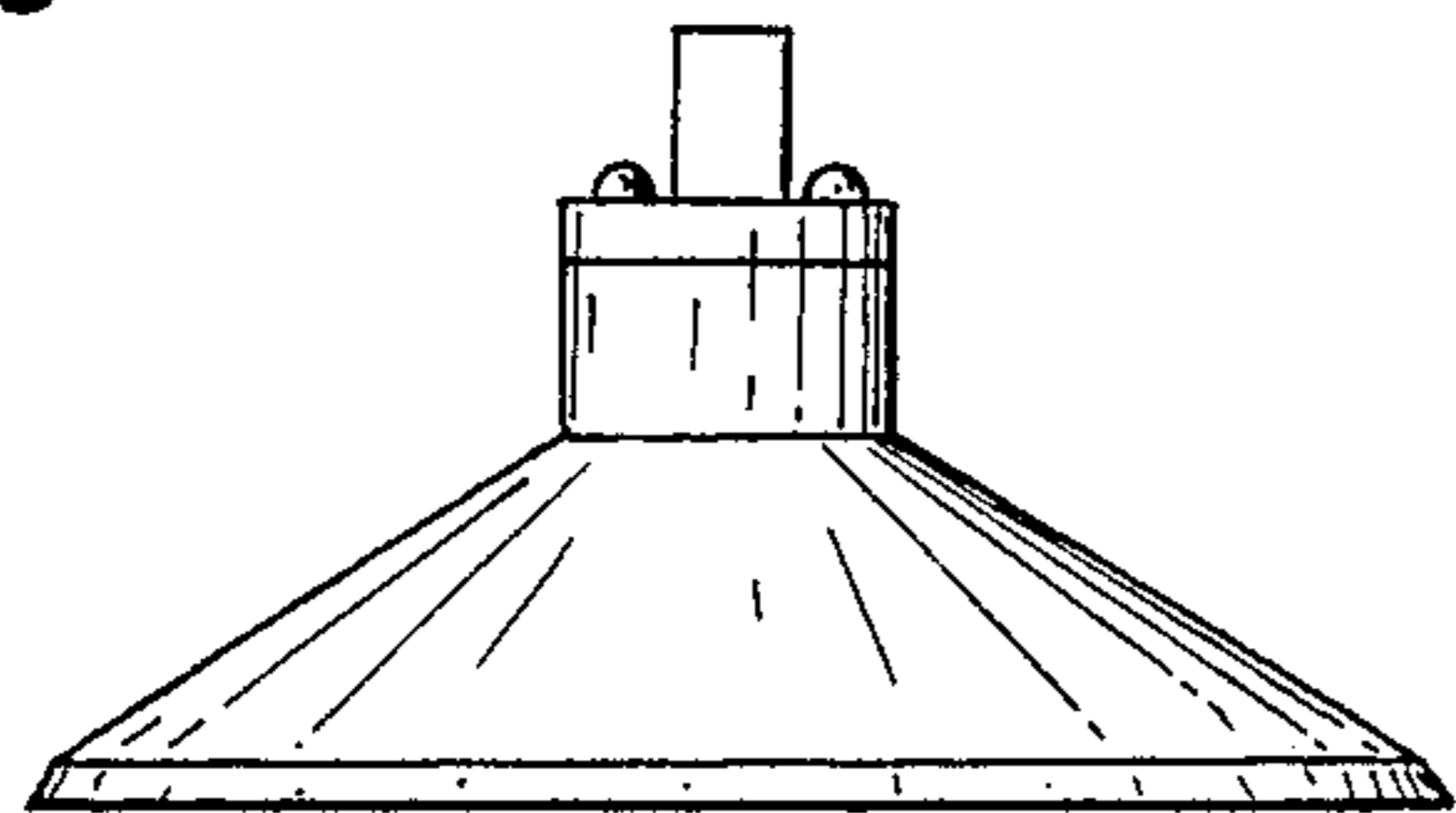

Fig. 6.

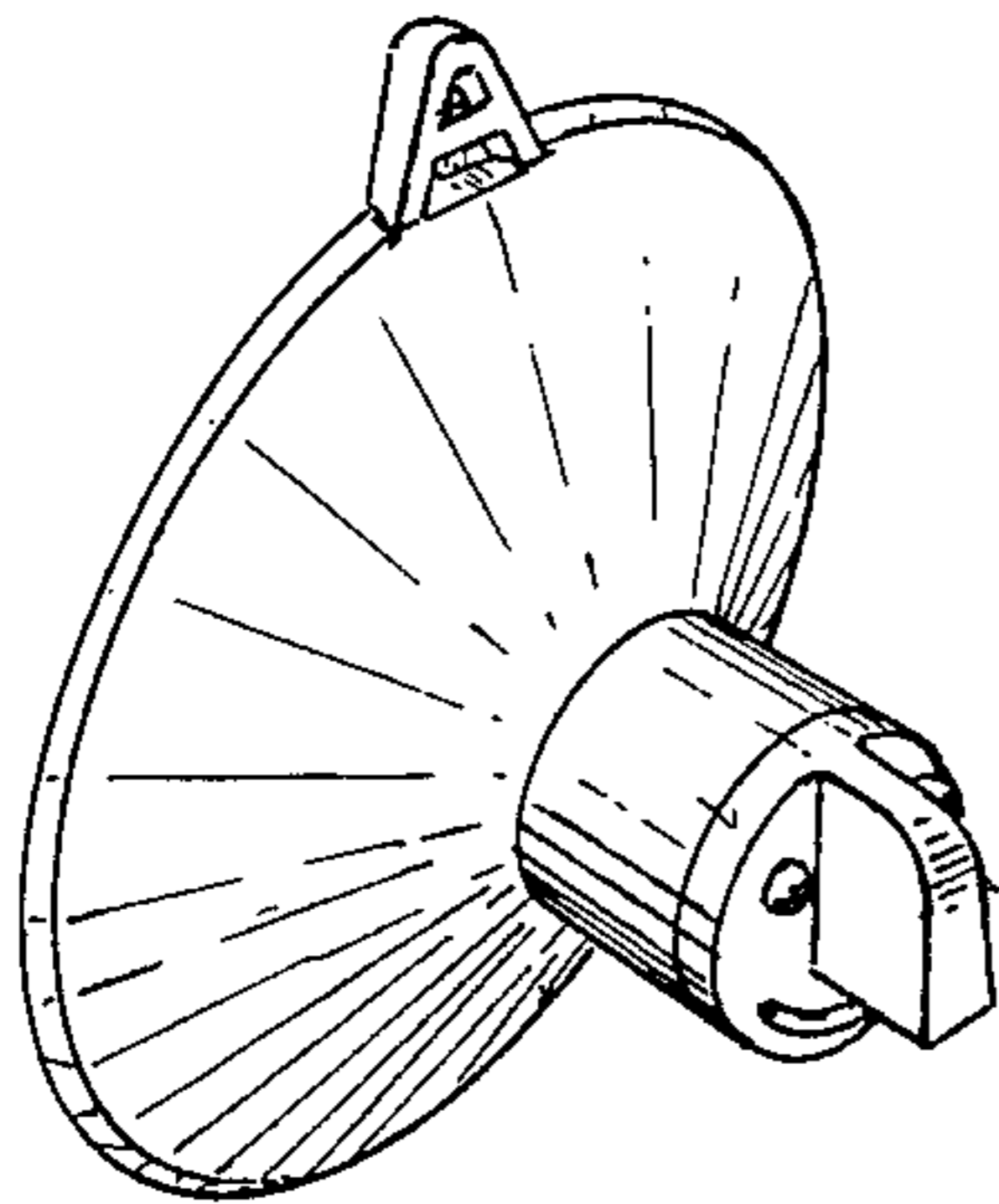

Fig. 7.

