

# United States Patent [19]

Kasprzycki

[11] Patent Number: **Des. 311,926**

[45] Date of Patent: **\*\* Nov. 6, 1990**

[54] **TYPEWRITER**

[75] Inventor: **Robert L. Kasprzycki, Pompey, N.Y.**

[73] Assignee: **Smith Corona Corporation, Cortland, N.Y.**

[\*\*] Term: **14 Years**

[21] Appl. No.: **40,654**

[22] Filed: **Apr. 17, 1987**

[52] U.S. Cl. .... **D18/1**

[58] Field of Search ..... **D18/1, 2, 11;**  
**235/145 R, 145 A; 400/109-111, 472, 485, 486,**  
**690.3, 690.4, 691-694**

[56] **References Cited**

**U.S. PATENT DOCUMENTS**

D. 281,509 11/1985 Jolliffe ..... D18/1  
D. 290,849 7/1987 Gubbe et al. .... D18/1  
D. 299,248 1/1989 Kasagi et al. .... D18/1

D. 299,249 1/1989 Kasagi et al. .... D18/1  
D. 301,041 5/1989 Kasprzycki ..... D18/1

**OTHER PUBLICATIONS**

Ericsson 7700 Typewriter brochure.

*Primary Examiner*—Nelson C. Holtje

*Assistant Examiner*—Caron D. Veynar

[57] **CLAIM**

The ornamental design for a typewriter, as shown.

**DESCRIPTION**

FIG. 1 is a right, front perspective view of a typewriter showing my new design;

FIG. 2 is a top plan view thereof;

FIG. 3 is a bottom plan view thereof;

FIG. 4 is a front elevational view thereof;

FIG. 5 is a rear elevational view thereof;

FIG. 6 is a left side elevational view thereof; and

FIG. 7 is a right side elevational view thereof.

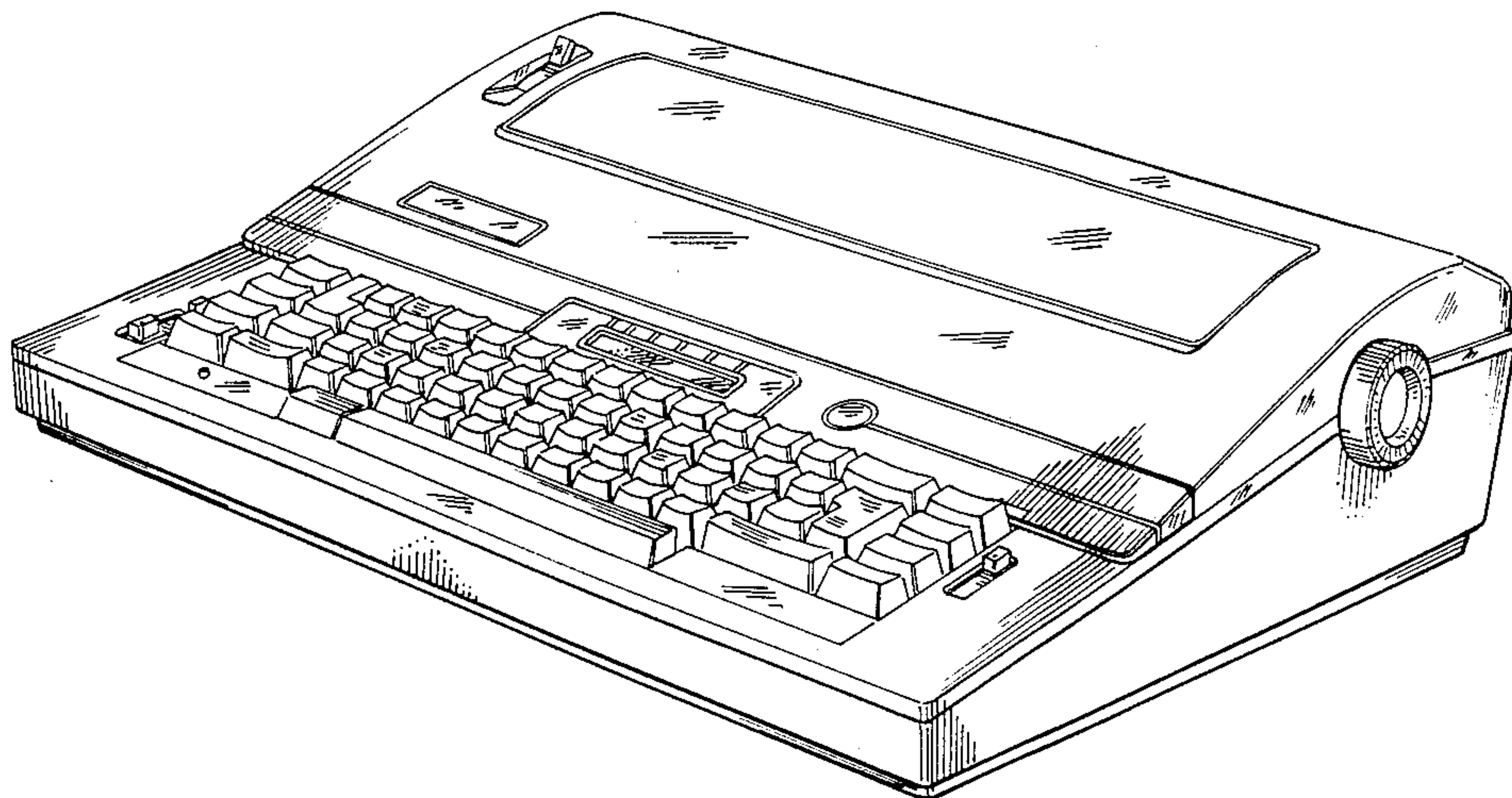

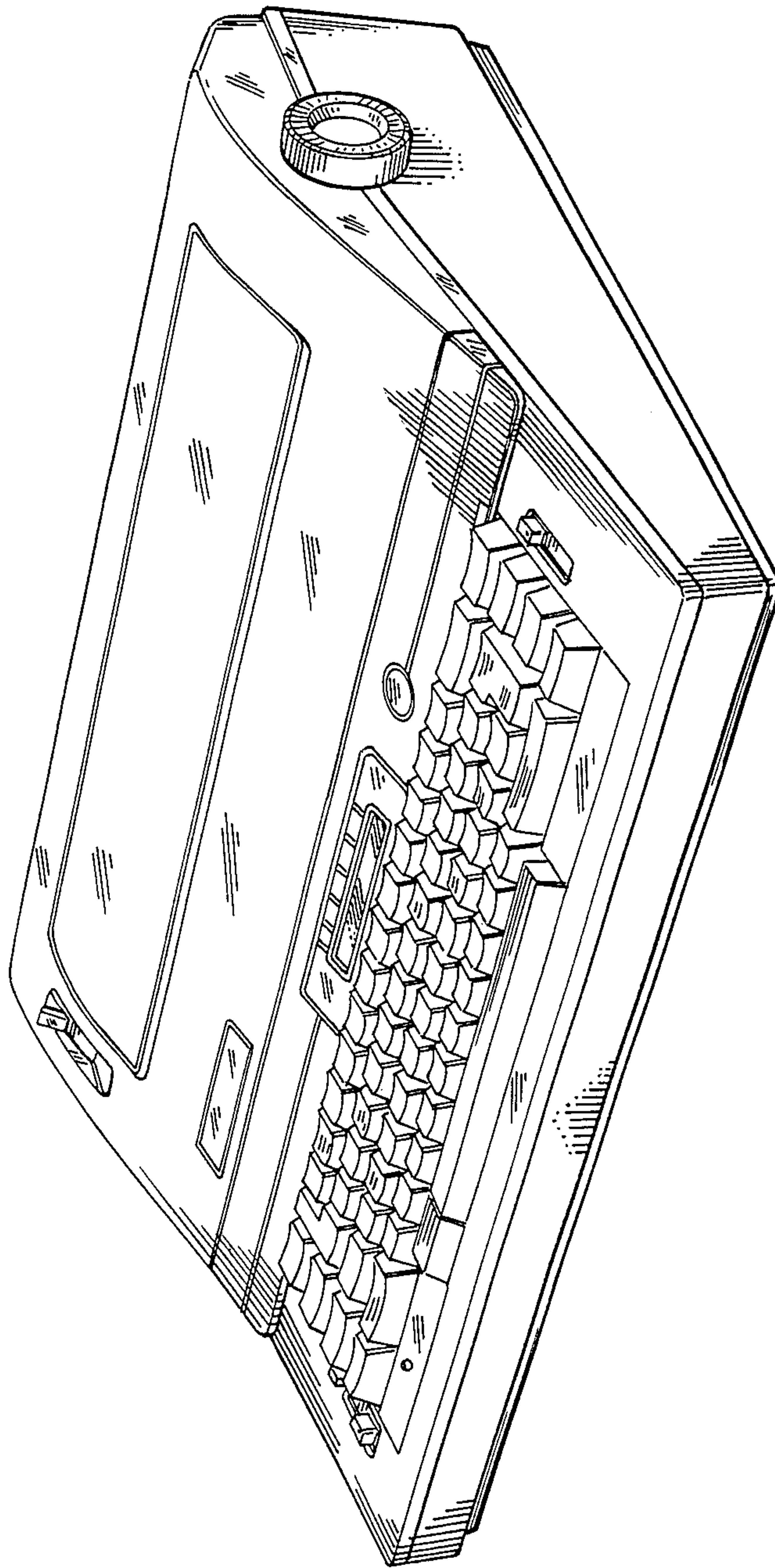
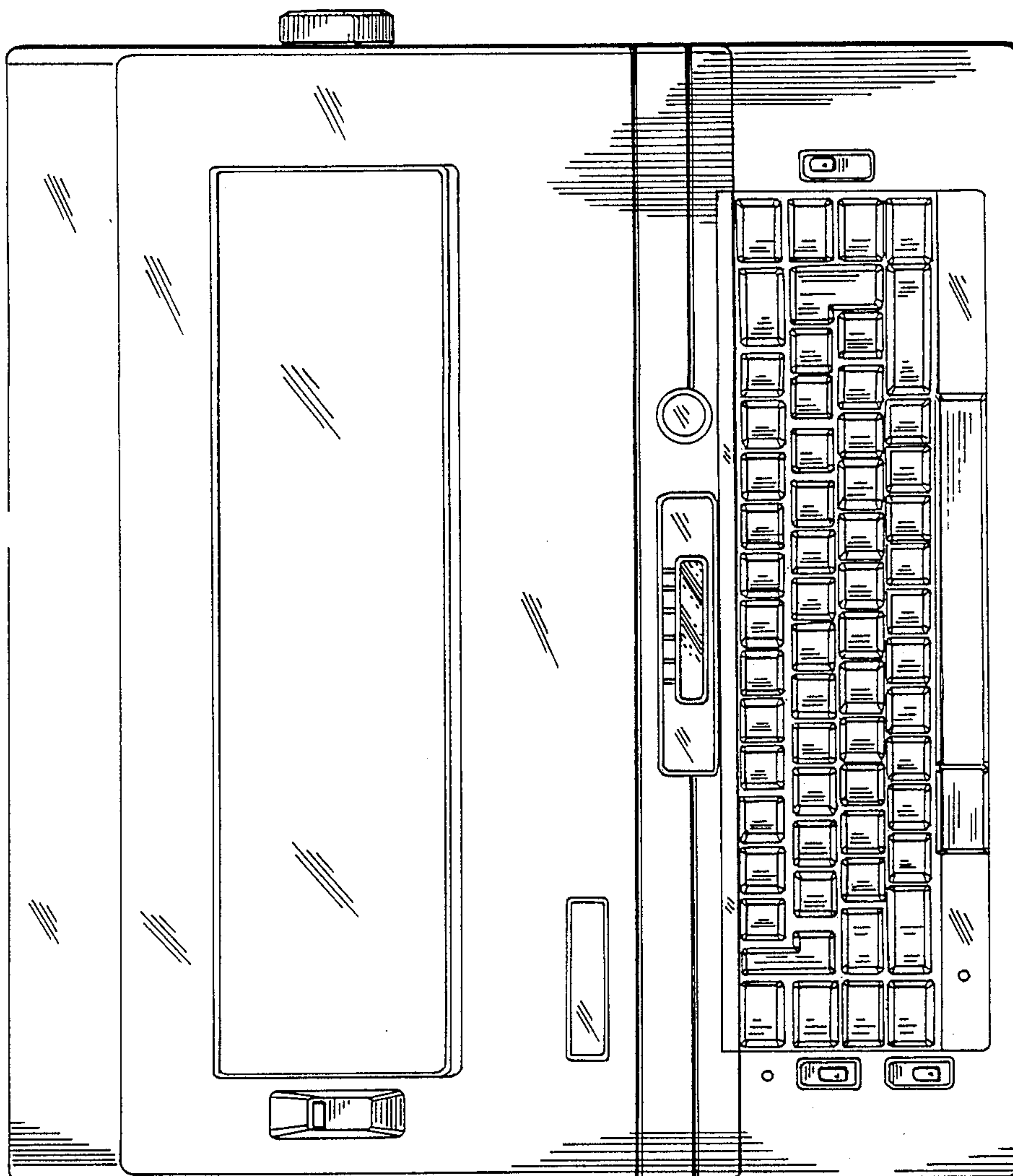

FIG. 1



五二四二

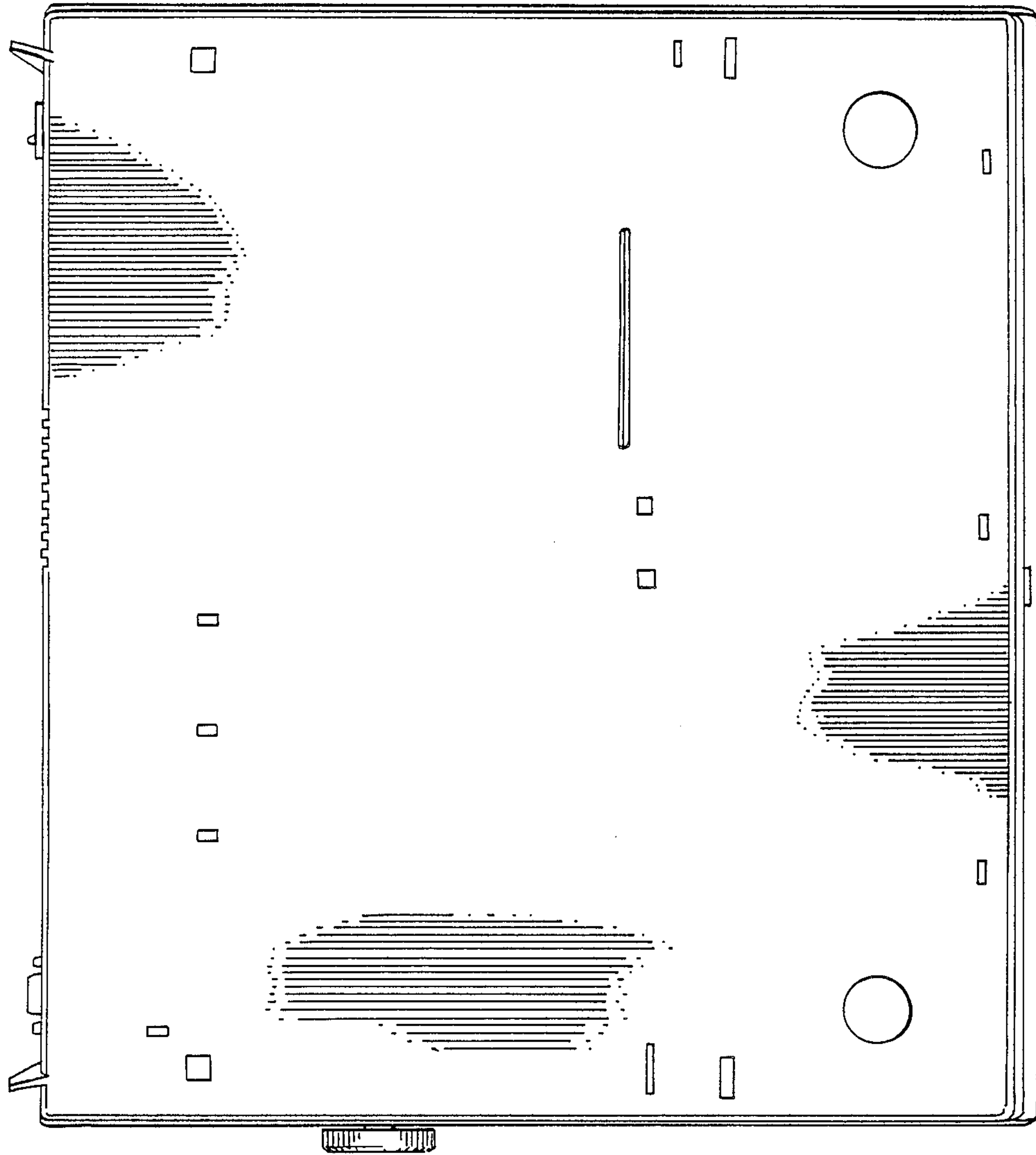

FIG. 5



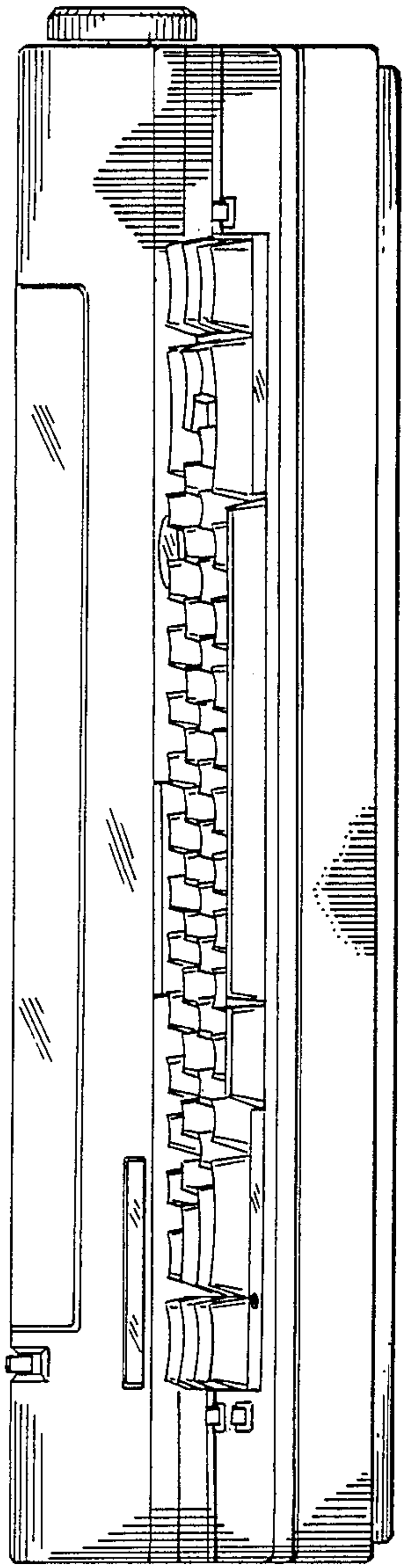

Fig 4

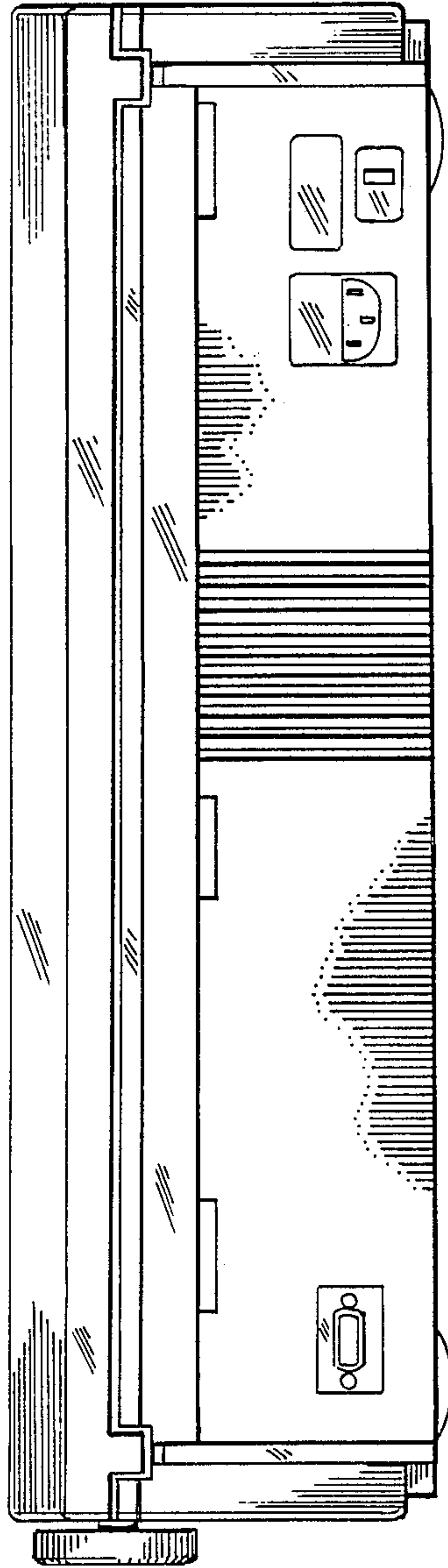

Fig 5

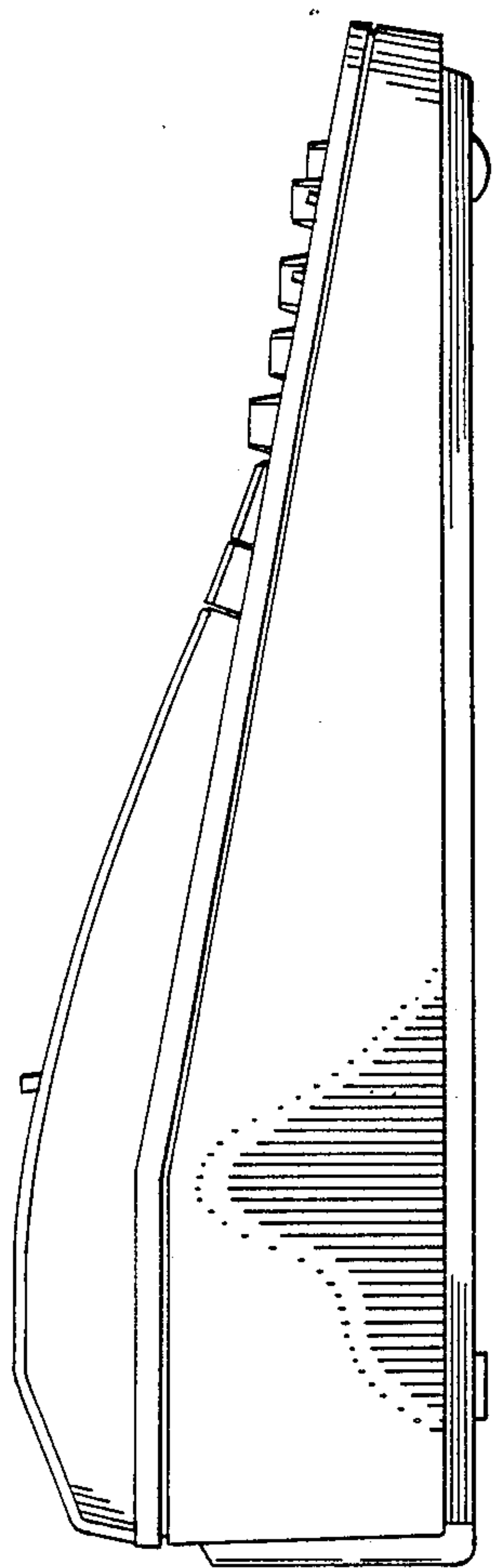

Fig. 6

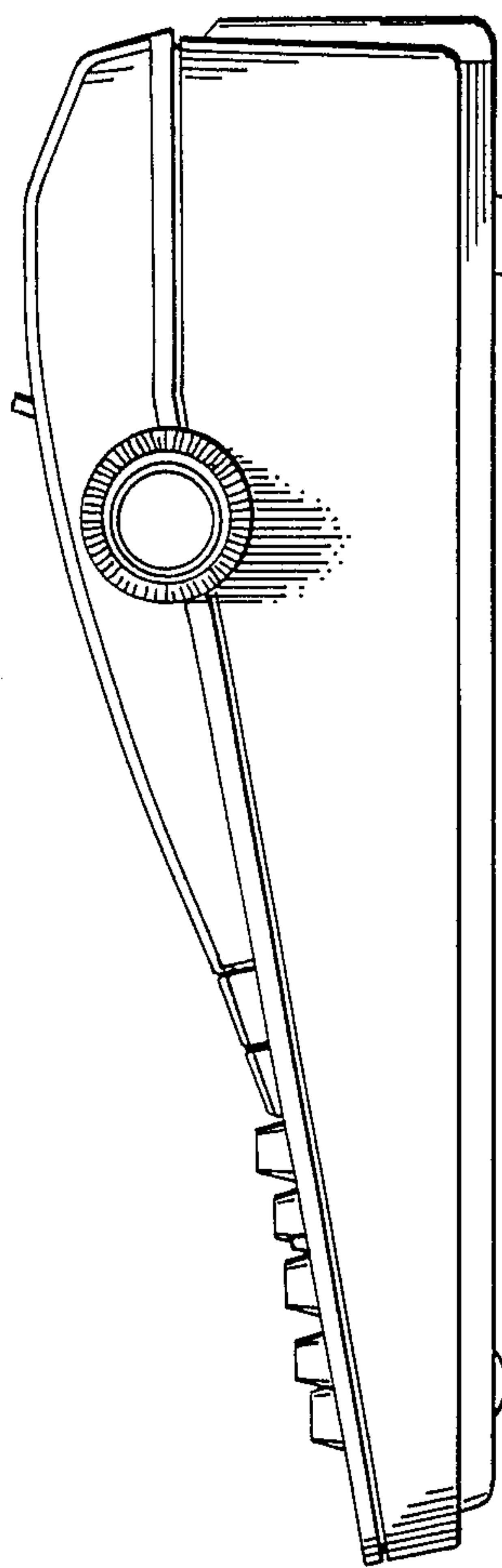

Fig. 7