

FIG. 1

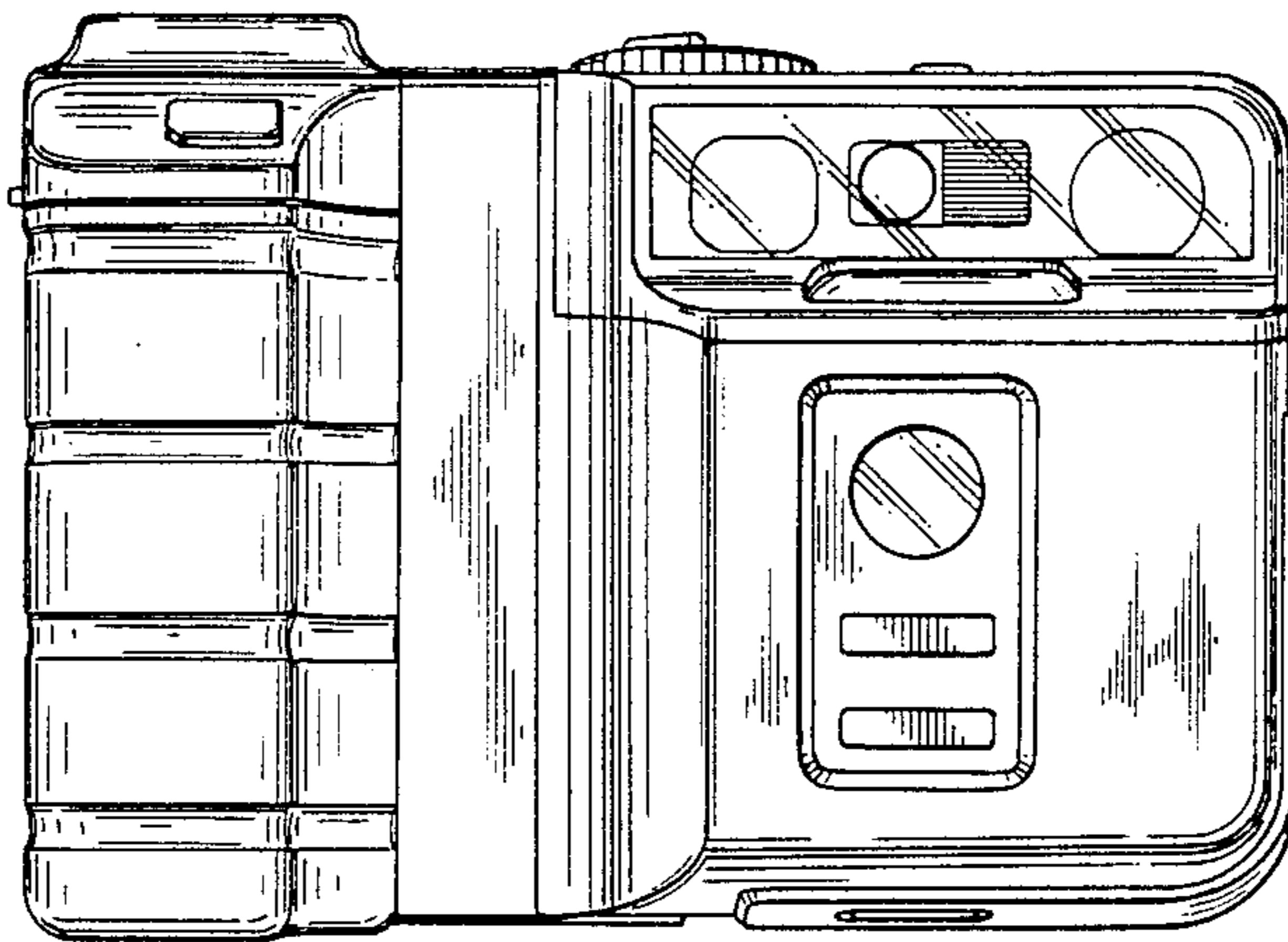
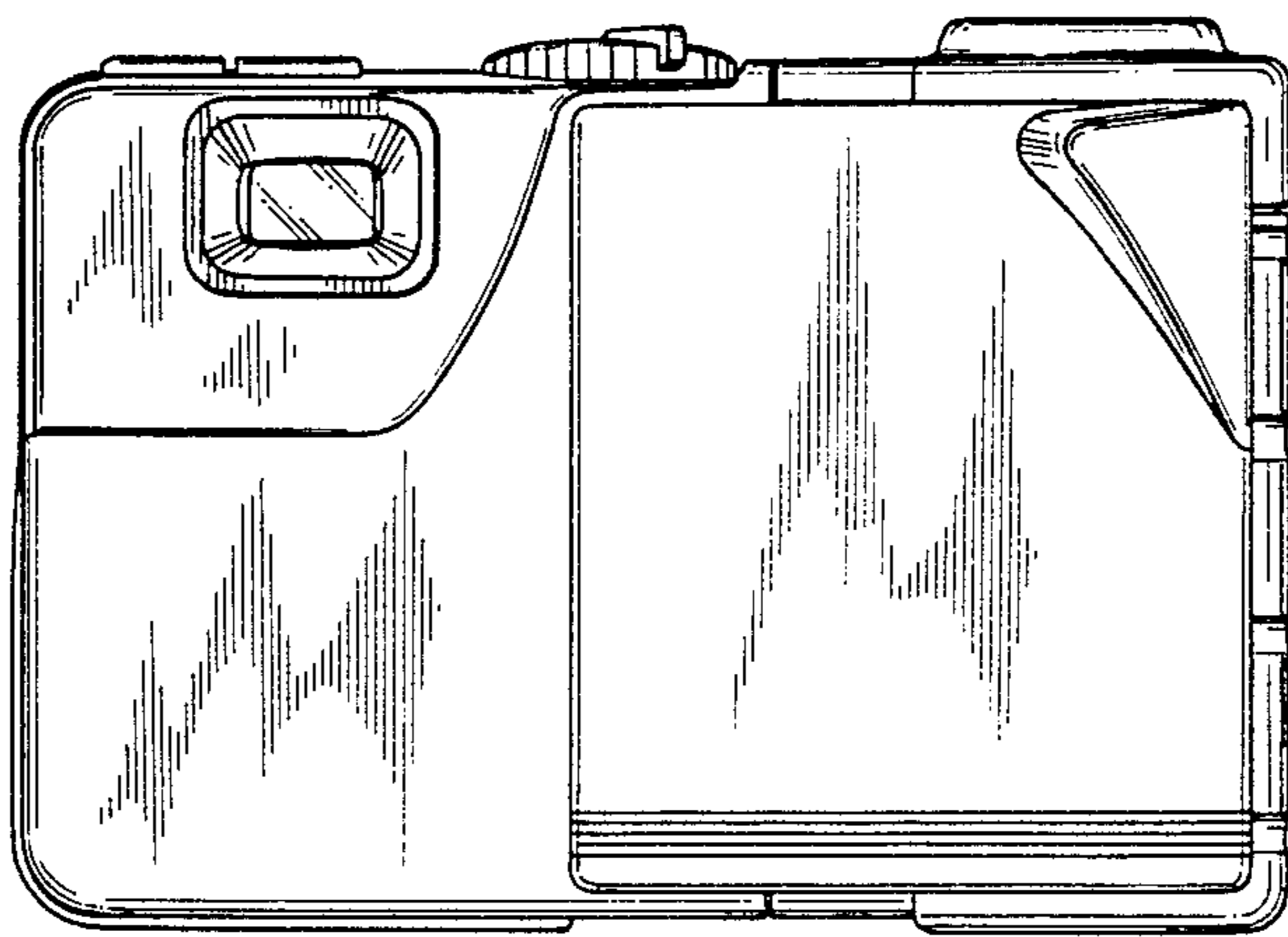

FIG. 2



[54] **CAMERA**
[75] **Inventor: Nobuo Kikuchi, Tokyo, Japan**
[73] **Assignee: Canon Kabushiki Kaisha, Tokyo, Japan**
[**] **Term: 14 Years**
[21] **Appl. No.: 110,498**
[22] **Filed: Oct. 20, 1987**
[30] **Foreign Application Priority Data**
Apr. 27, 1987 [JP] Japan 62-16683
[52] **U.S. Cl. D16/218**
[58] **Field of Search D16/200, 208, 209, 211, D16/212, 216, 217, 218; 354/82, 126, 149.11, 288**
[56] **References Cited**
U.S. PATENT DOCUMENTS
D. 279,573 7/1985 Agou et al. D16/1
D. 287,733 1/1087 Ago et al. D16/212

D. 289,176 4/1987 Yoshida et al. D16/218
D. 293,685 1/1988 Tanaka et al. D16/5
D. 293,917 1/1988 Tanaka et al. D16/5
D. 295,756 5/1988 Ando et al. D16/209
D. 305,665 1/1990 Suyama D16/209

Primary Examiner—Bernard Ansher
Assistant Examiner—Adir Aronovich
Attorney, Agent, or Firm—Fitzpatrick, Cella, Harper & Scinto

[57] **CLAIM**

The ornamental design for a camera, as shown.

DESCRIPTION

FIG. 1 is a front elevational view of a camera showing my new design;
FIG. 2 is a rear elevational view thereof;
FIG. 3 is a top plan view thereof;
FIG. 4 is a bottom plan view thereof;
FIG. 5 is a left side elevational view thereof;
FIG. 6 is a right side elevational view thereof; and
FIG. 7 is a front perspective view thereof.

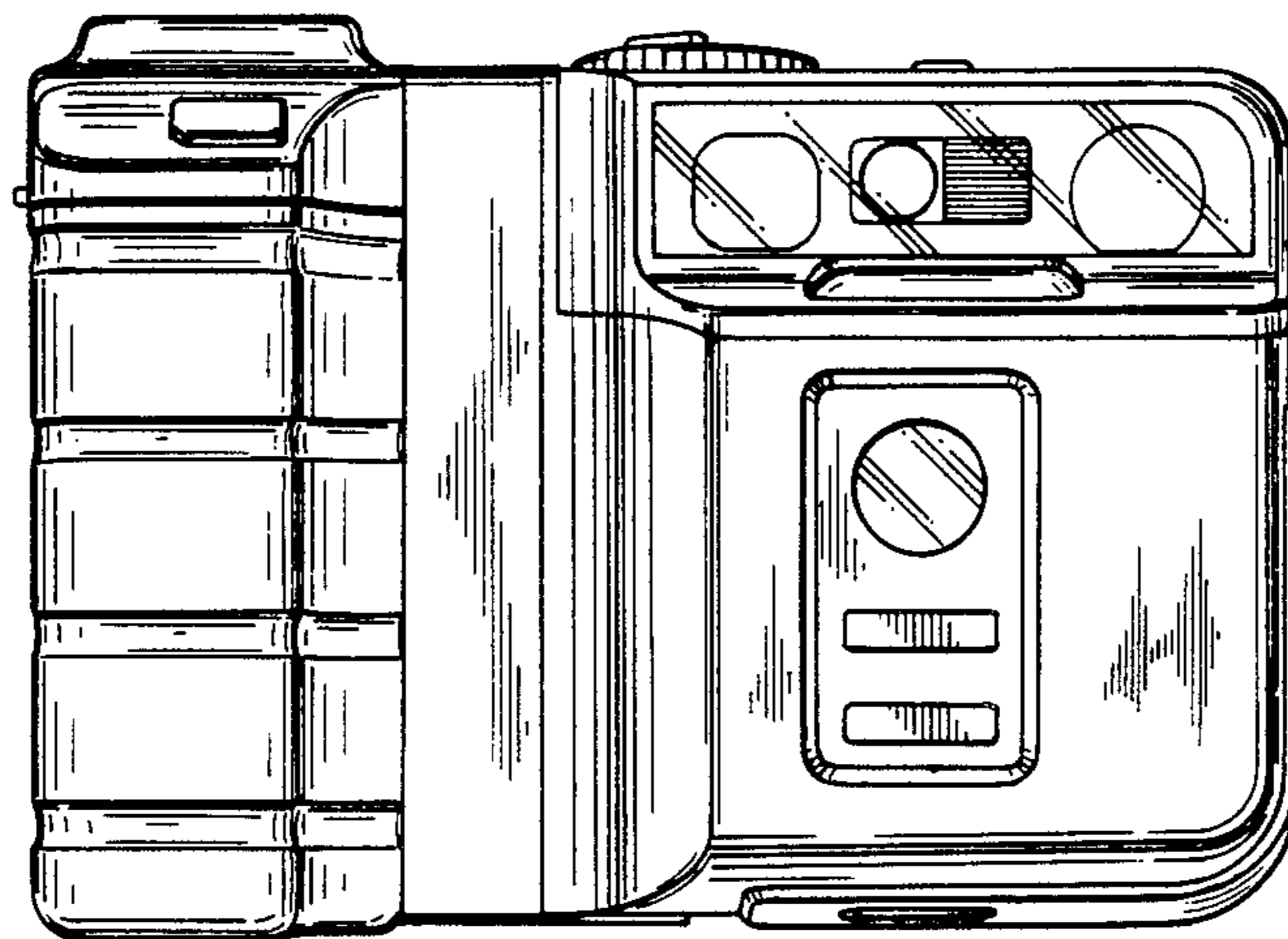

FIG. 3

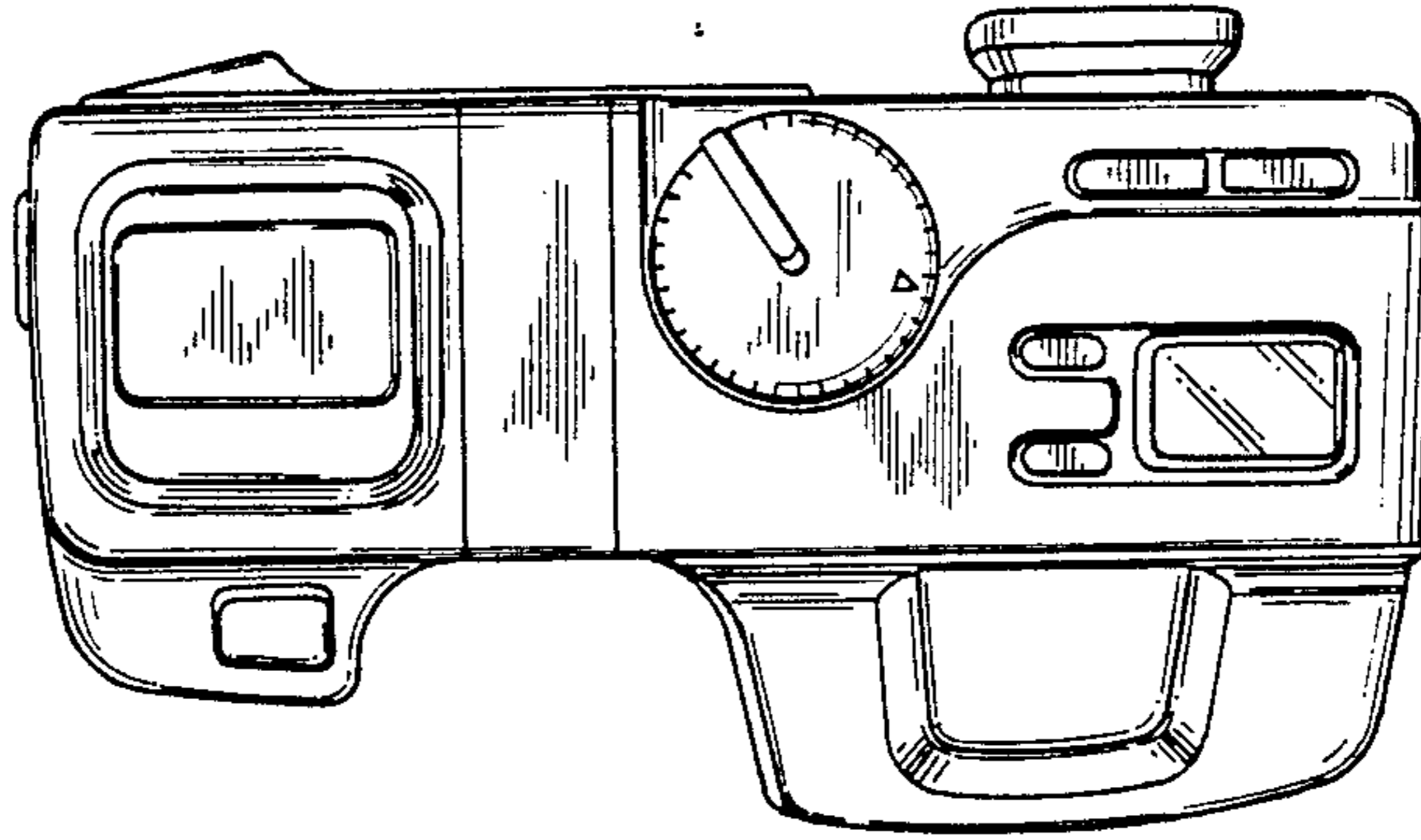

FIG. 4

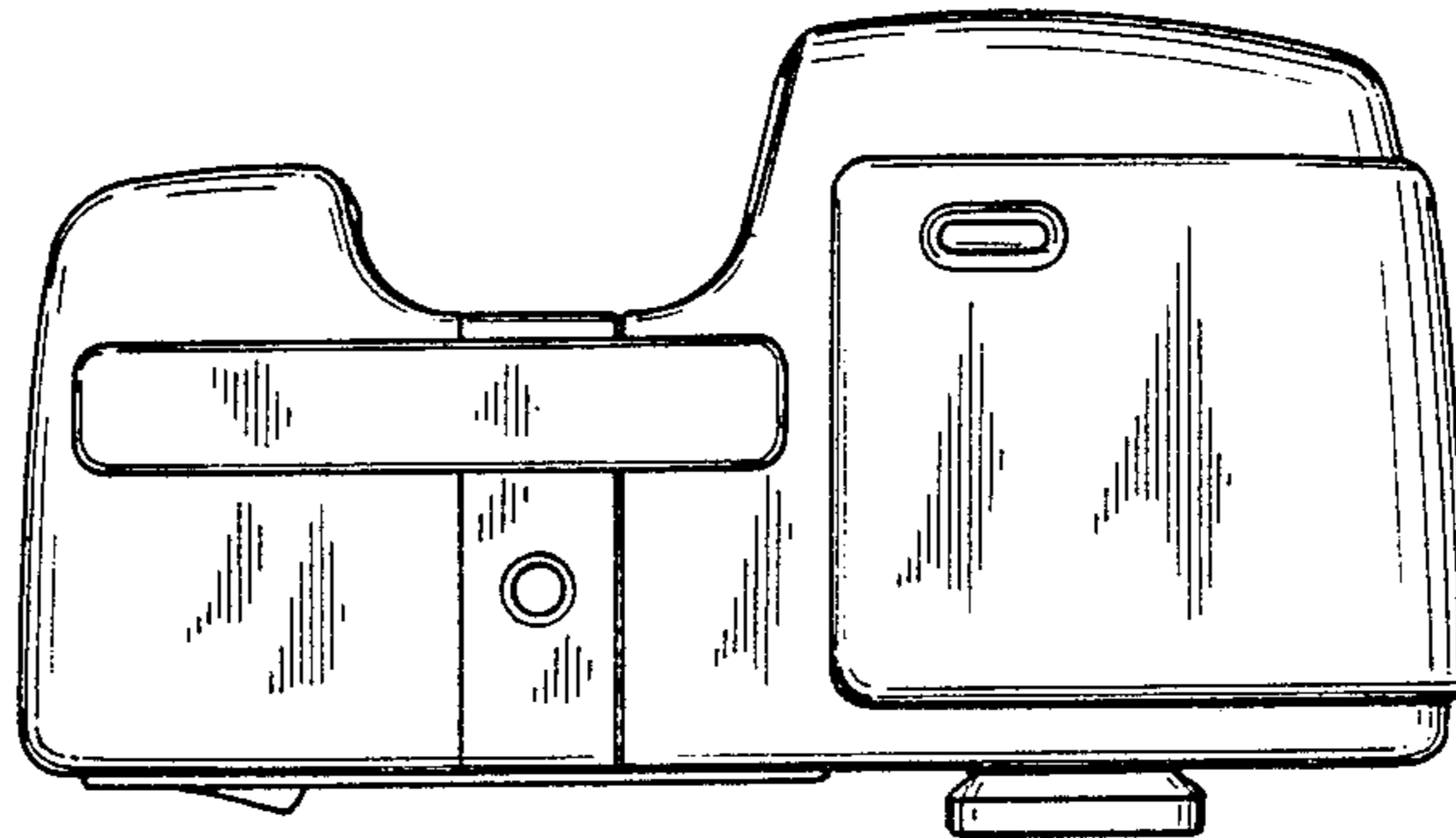

FIG. 5

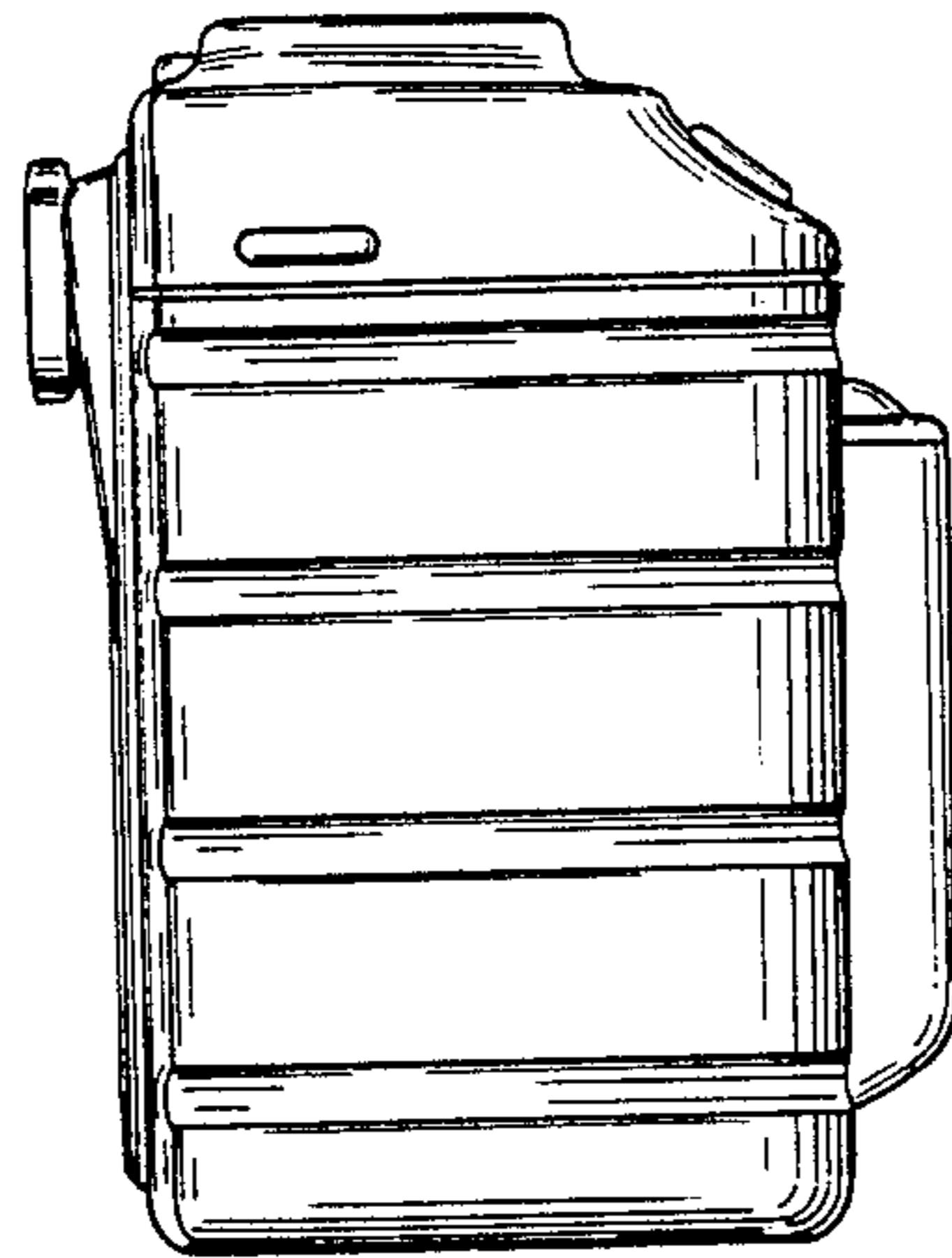

FIG. 6

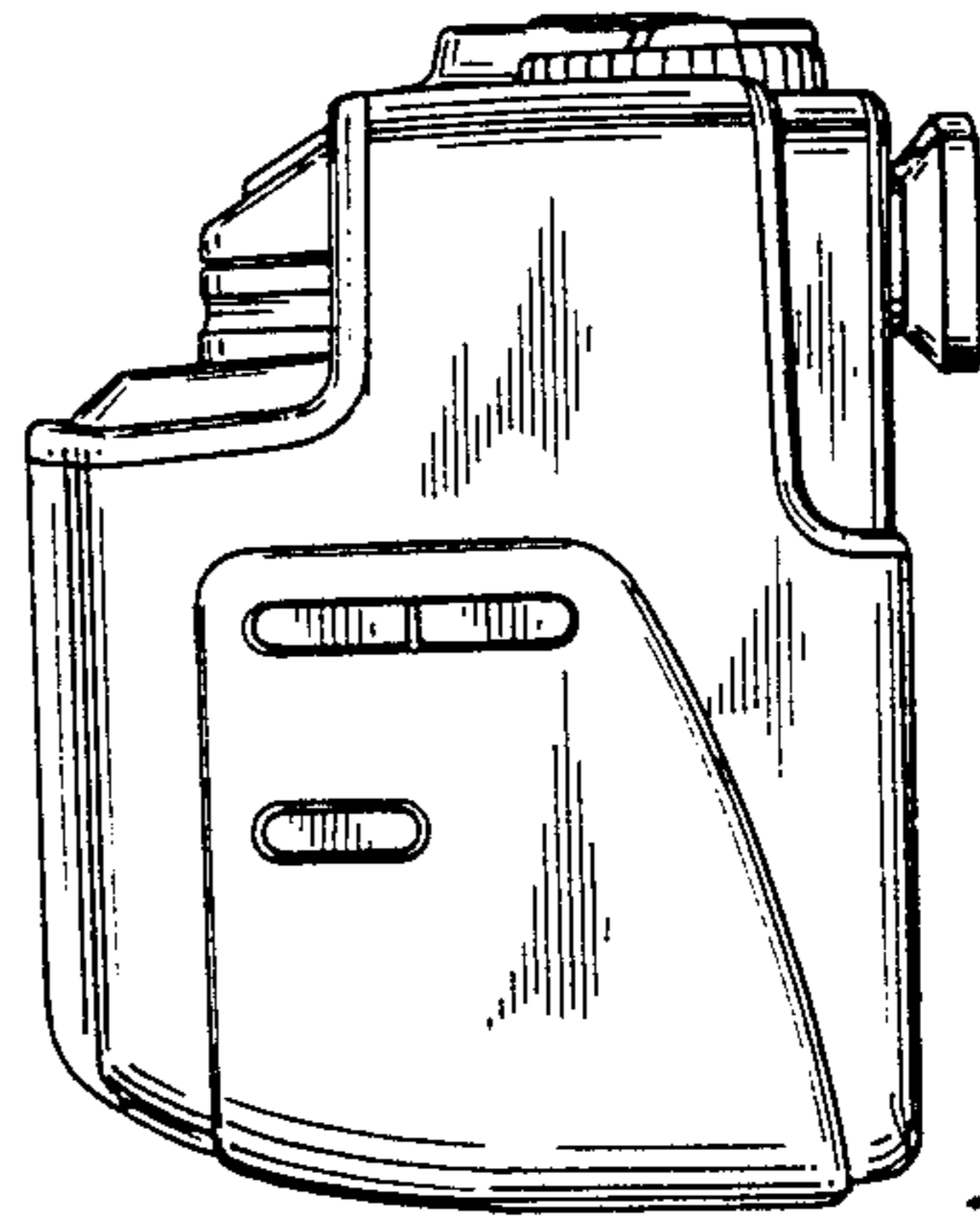

FIG. 7

