

[54] **STORAGE BOX**
[75] **Inventor: Heikki Kiiski, Turku, Finland**
[73] **Assignee: Treston Oy, Turku, Finland**
[**] **Term: 14 Years**
[21] **Appl. No.: 283,523**
[22] **Filed: Dec. 12, 1988**
[30] **Foreign Application Priority Data**
Sep. 23, 1988 [FI] Finland 761/88
Sep. 23, 1988 [FI] Finland 762/88
[52] **U.S. Cl. D34/40**
[58] **Field of Search D34/40-46;**
D9/424, 432, 341; D3/30.1, 35; 220/74, 83, 22,
22.3; 206/203, 387, 561, 518, 503, 505, 509;
D6/509, 510, 511

[56] **References Cited**
U.S. PATENT DOCUMENTS
D. 247,645 3/1978 Woodhall D3/35
D. 268,379 3/1983 Dishell D3/35
D. 274,205 6/1984 Kates D6/509
D. 274,967 8/1984 Taylor D34/40 X
D. 282,883 3/1986 Kiiski D34/40
4,577,773 3/1986 Bitel 220/22 X
4,627,535 12/1986 Kirchner et al. 220/22.3 X

4,722,453 2/1988 Hamilton 220/22.3

Primary Examiner—Bernard Ansher
Assistant Examiner—Prabhakar Deshmukh
Attorney, Agent, or Firm—Scully, Scott, Murphy & Presser

[57] **CLAIM**
The ornamental design for storage box, as shown and described.

DESCRIPTION

FIG. 1 is a top perspective view of a storage box showing my new design;
FIG. 2 is a left side elevation thereof, the right side elevation being a mirror image thereof;
FIG. 3 is a top plan view thereof;
FIG. 4 is a bottom plan view thereof;
FIG. 5 is a front elevation view thereof;
FIG. 6 is a rear elevation thereof;
FIG. 7 is a top perspective view of another embodiment of FIG. 1;
FIG. 8 is a left side elevation of FIG. 7, the right side elevation being a mirror image thereof;
FIG. 9 is a top plan view of FIG. 7;
FIG. 10 is a bottom plan view of FIG. 7;
FIG. 11 is a front elevation of FIG. 7; and
FIG. 12 is a rear elevation of FIG. 7.

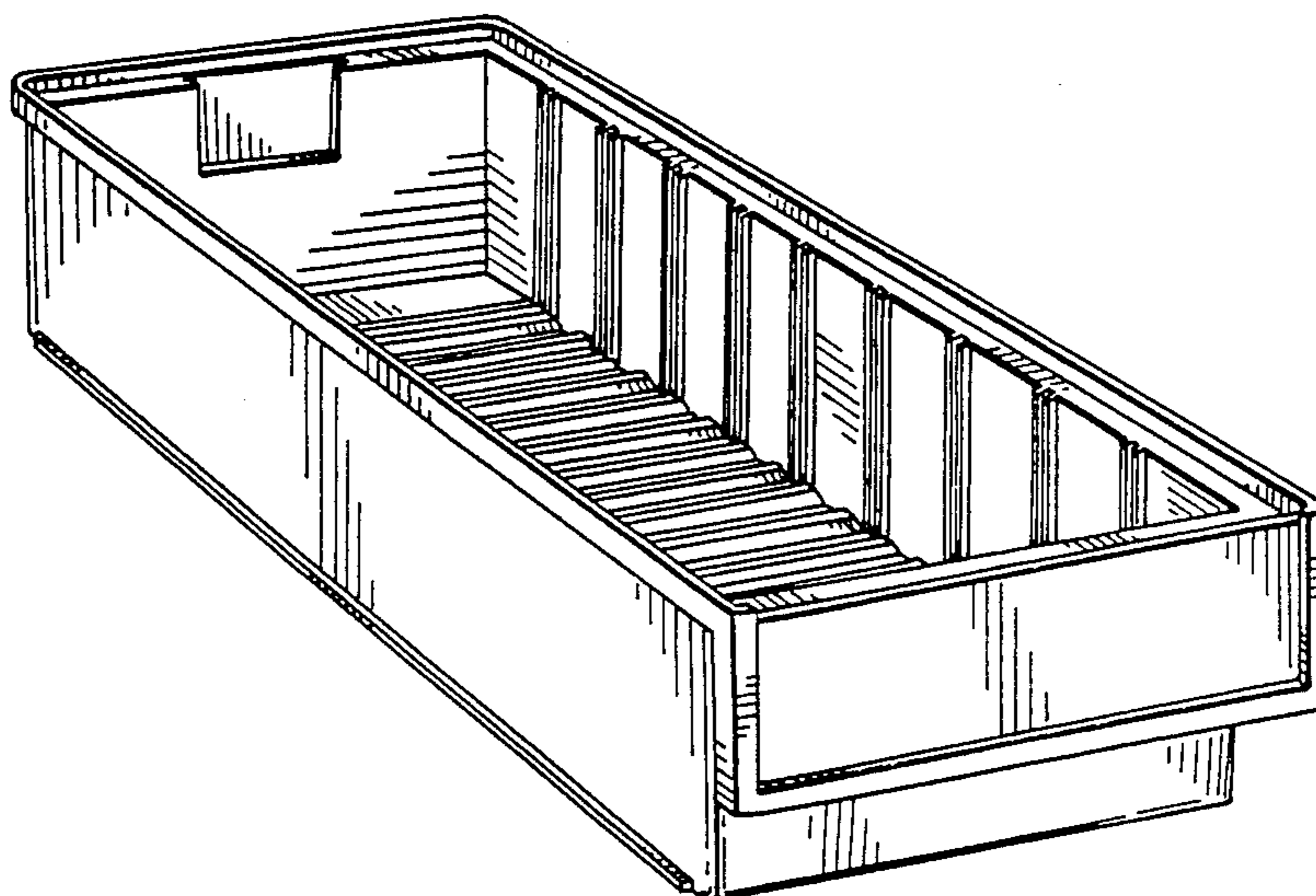

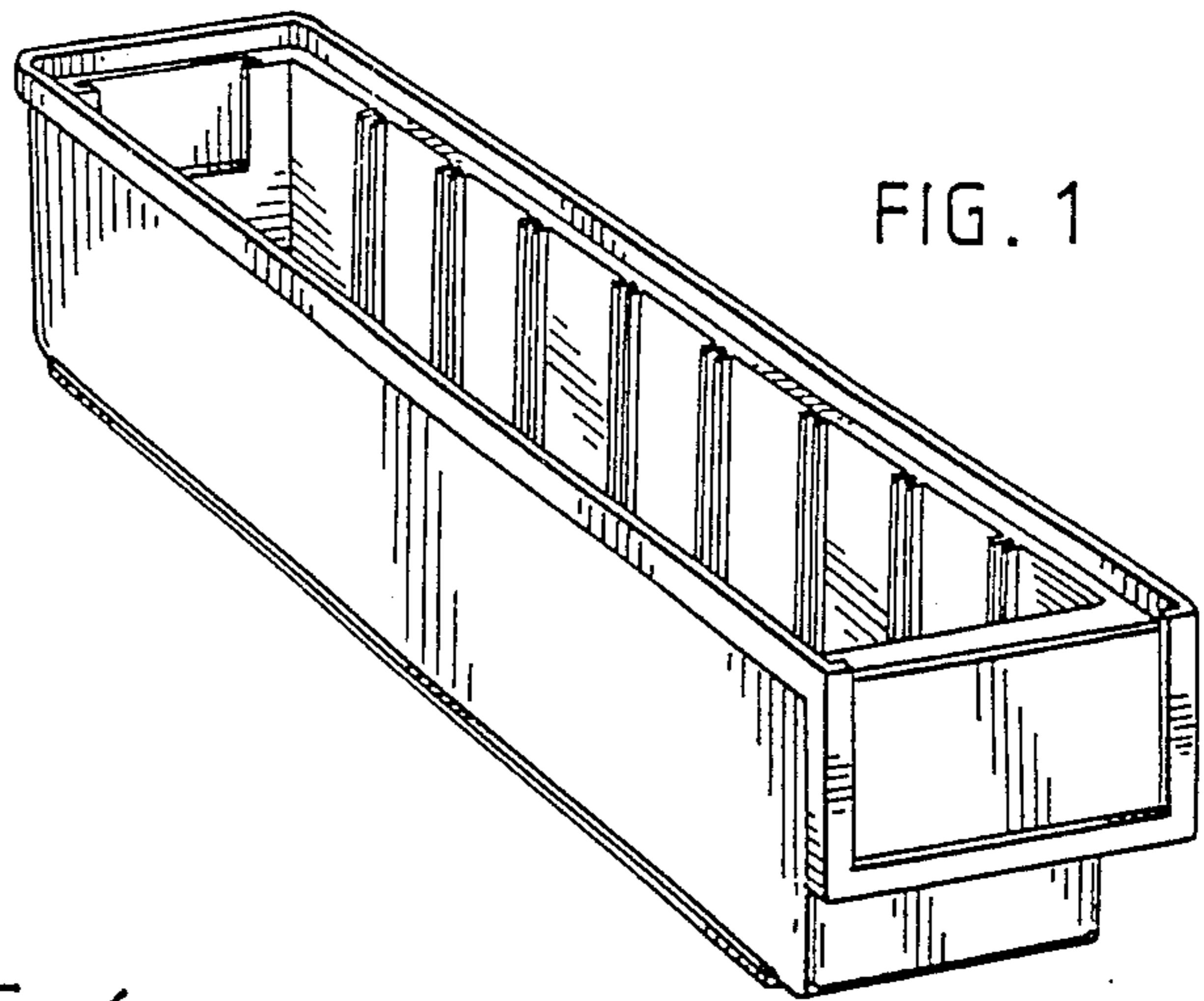

FIG. 1

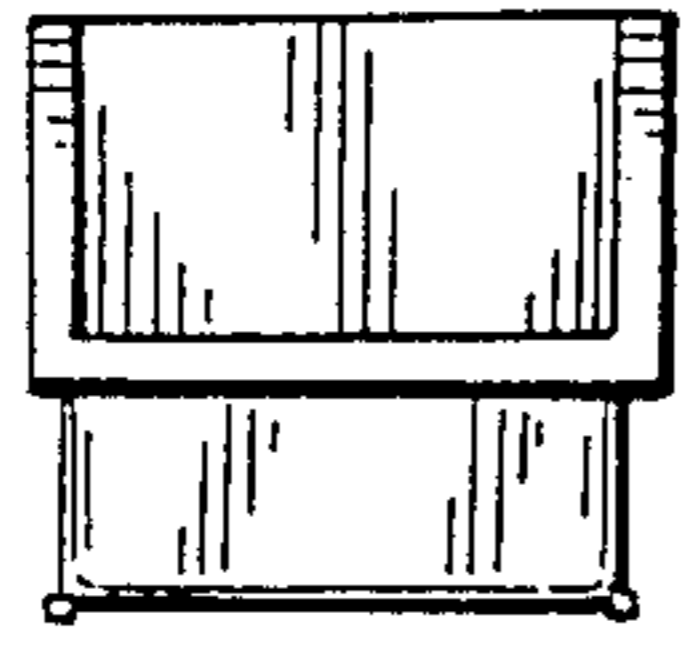

FIG. 5

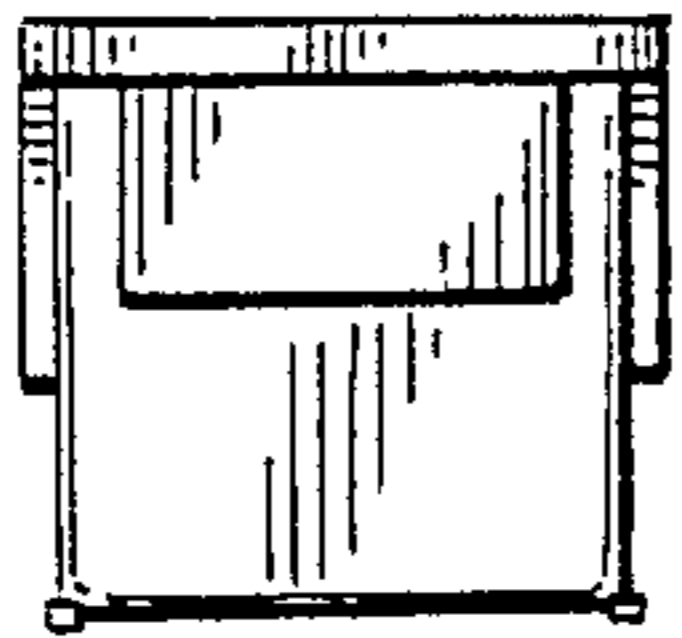

FIG. 6

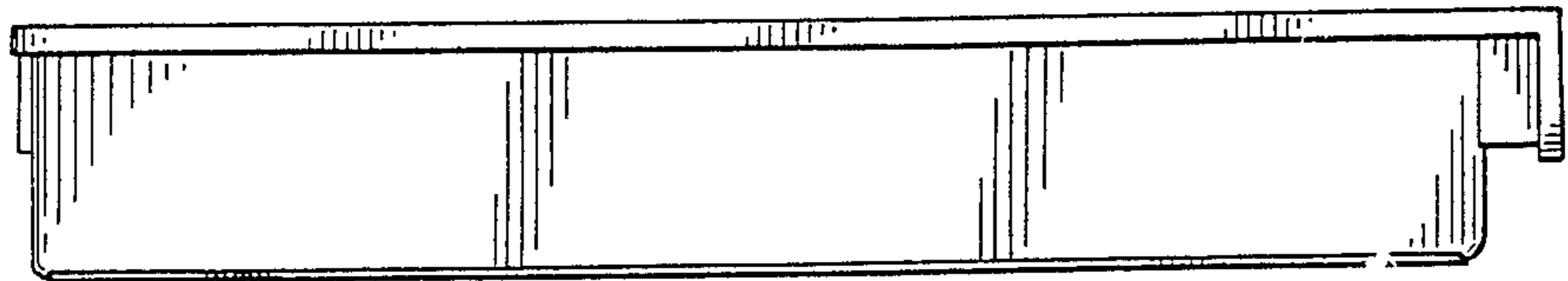

FIG. 2

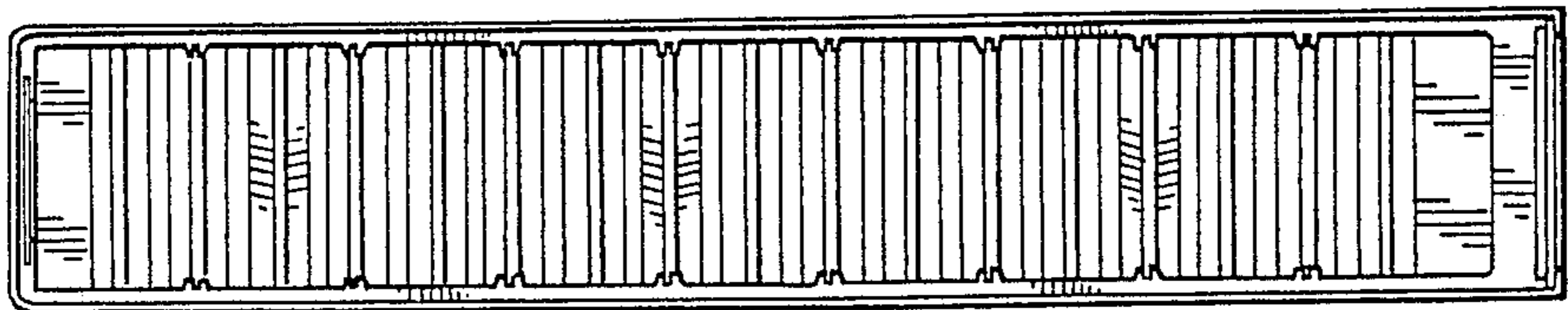

FIG. 3

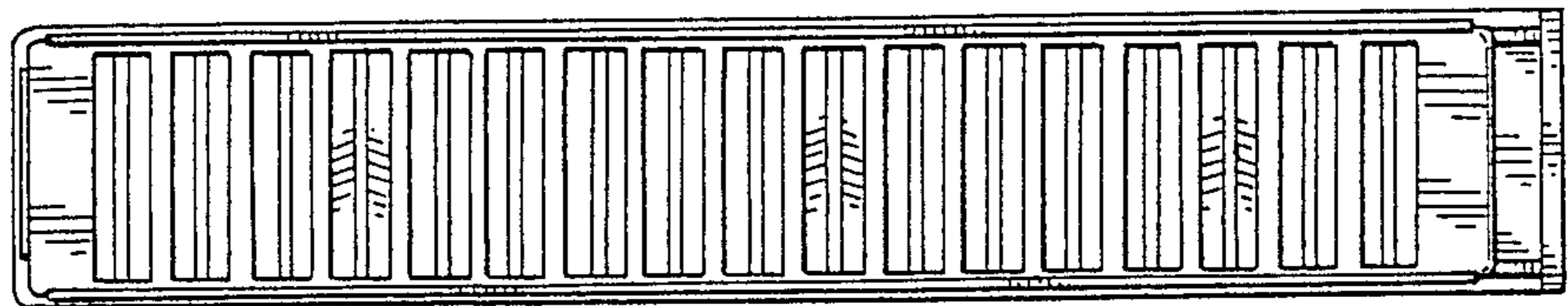

FIG. 4

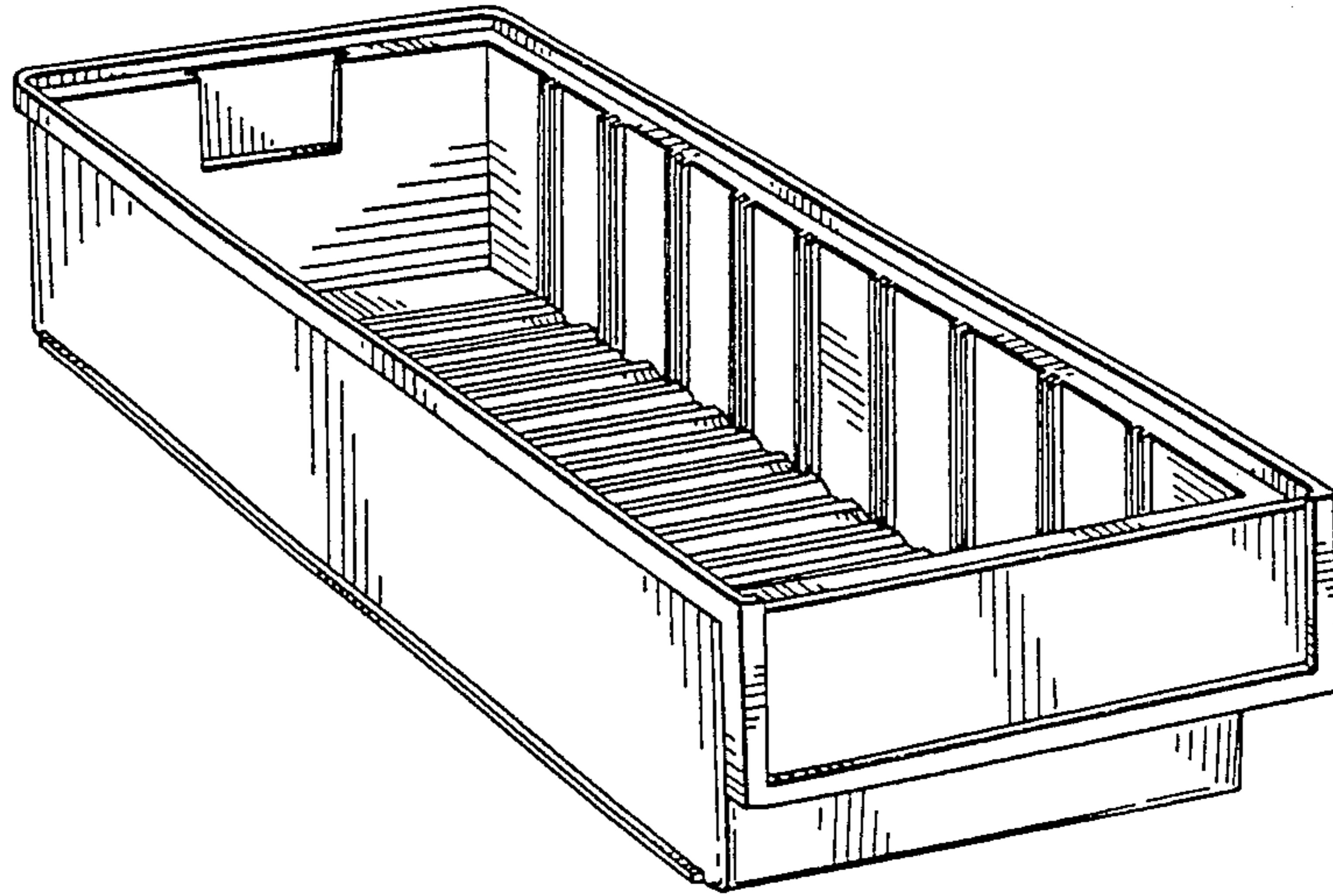

FIG. 7

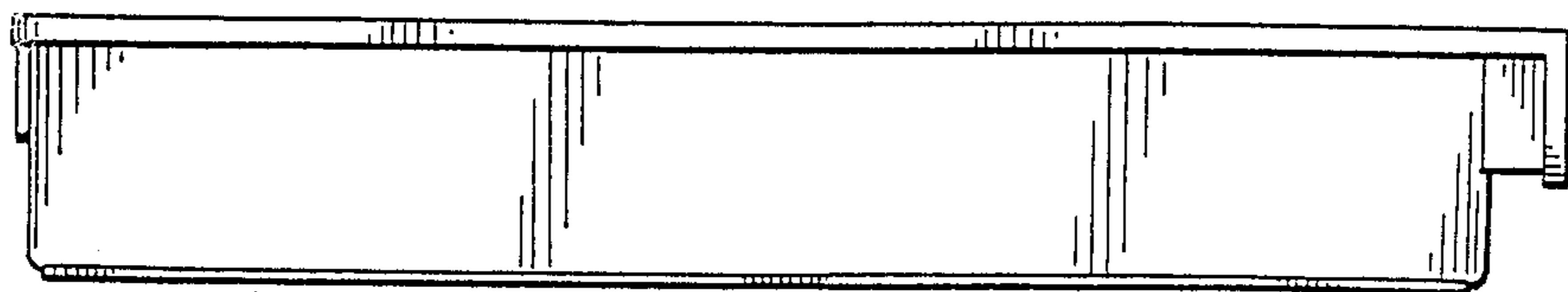

FIG. 8

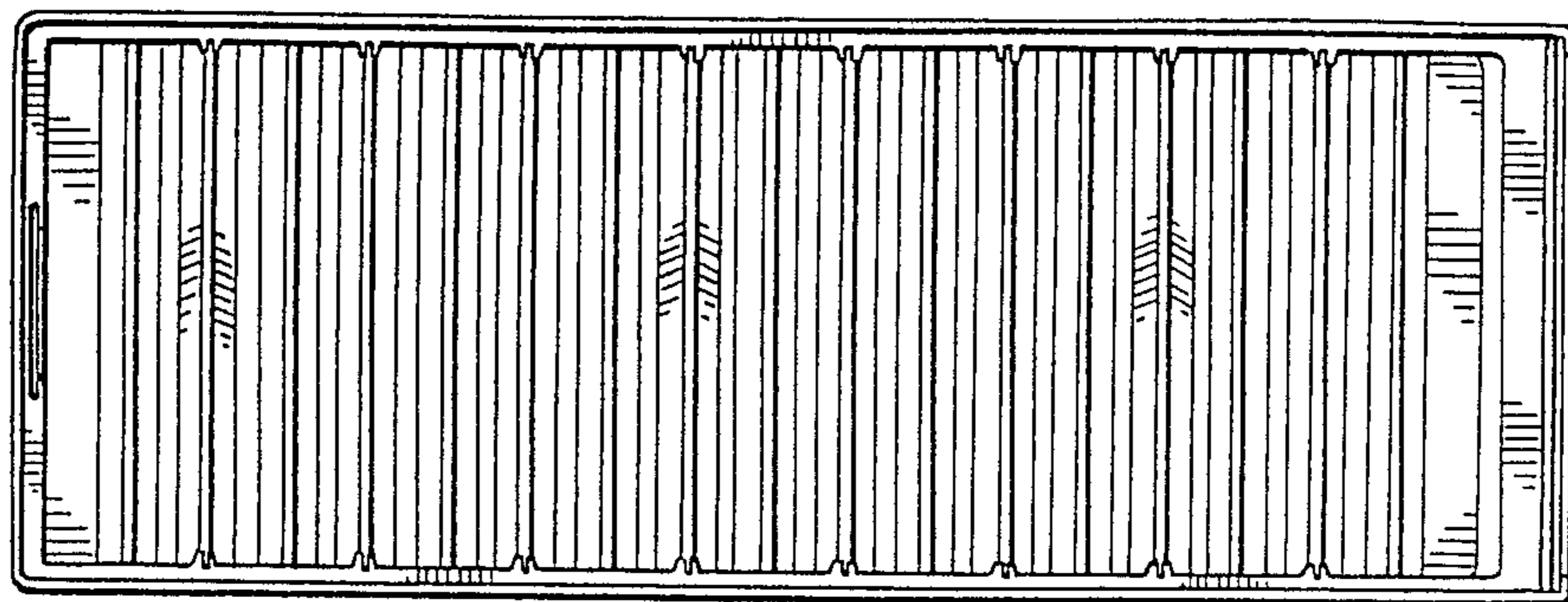

FIG. 9

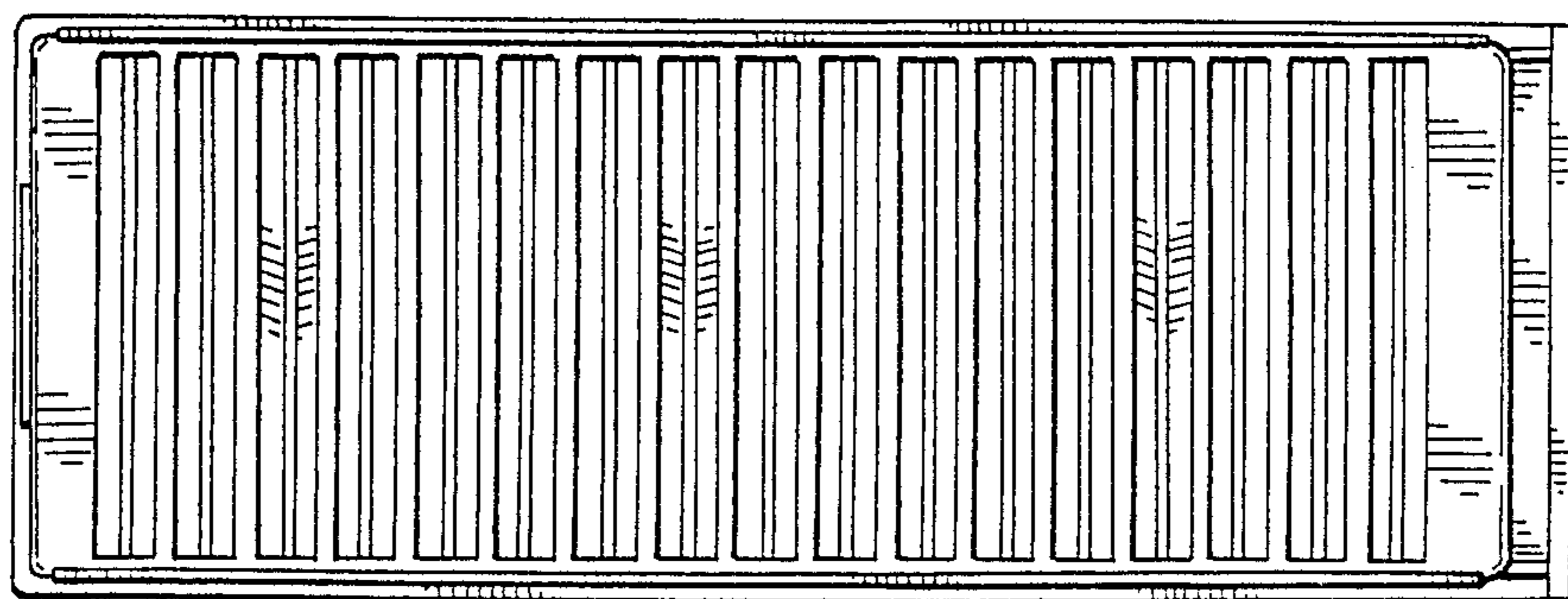

FIG. 10

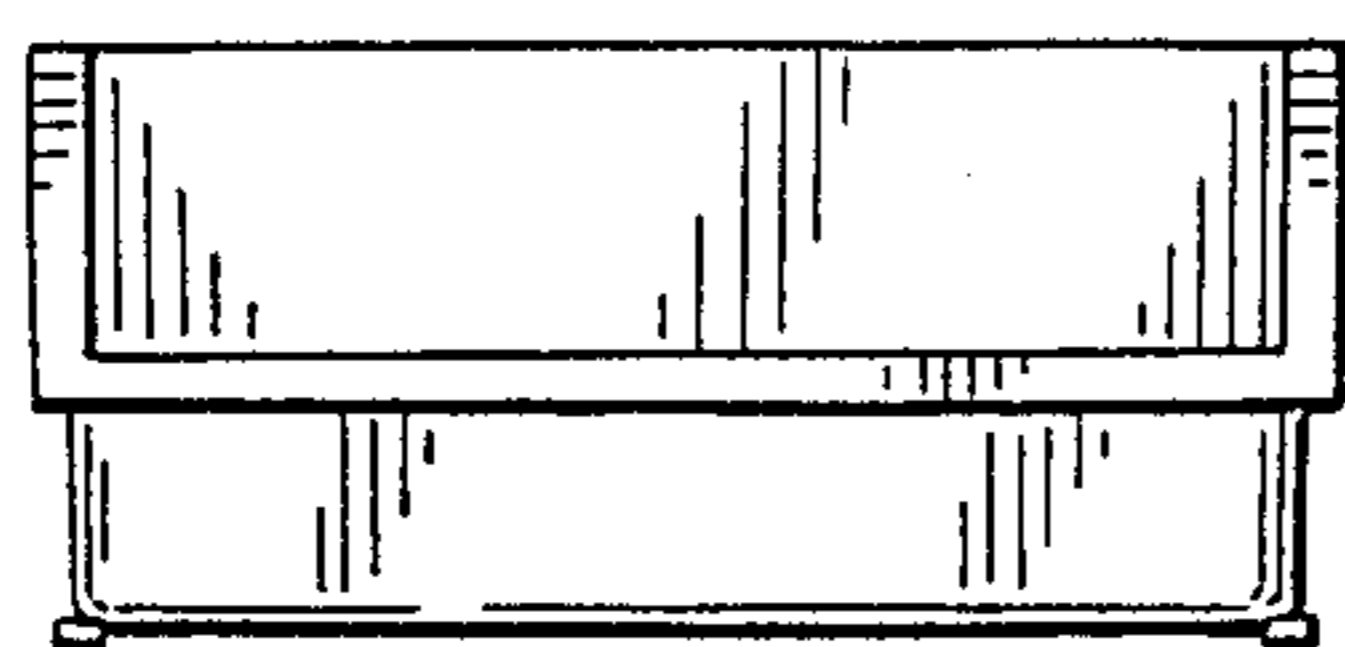

FIG. 11

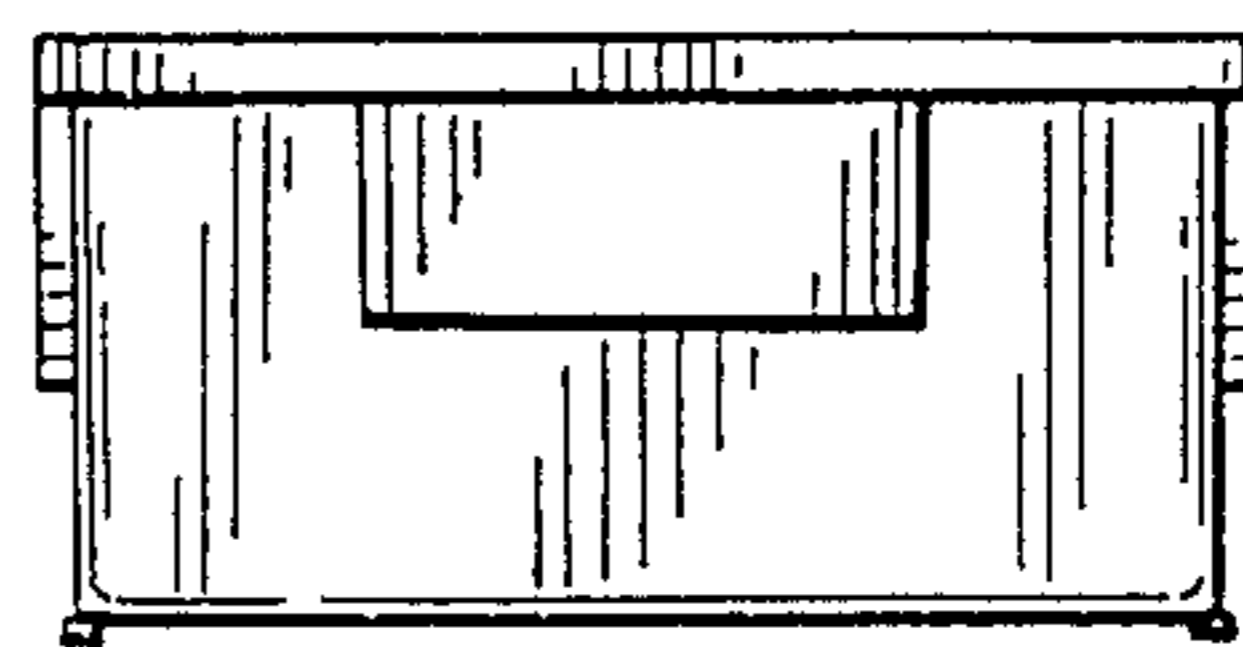

FIG. 12