

[54] **PET BATH WITH SHOWER**

[56] **References Cited**

[76] **Inventor: Gary A. Barone, 4616 Surrey Rd., Harrisburg, Pa. 17109**

U.S. PATENT DOCUMENTS

257,596 5/1882 Mond 119/1

Primary Examiner—Louis S. Zarfaz
Attorney, Agent, or Firm—Jerry T. Kearns

[**] **Term: 14 Years**

[57] **CLAIM**

The ornamental design for a pet bath with shower, as shown and described.

[21] **Appl. No.: 112,762**

DESCRIPTION

[22] **Filed: Oct. 26, 1987**

FIG. 1 is a front elevational view of a pet bath with shower, showing my new design;

[52] **U.S. Cl. D30/158**

FIG. 2 is a rear elevational view thereof;

[58] **Field of Search D30/161, 162, 108-120, D30/158; D7/104; 15/257.1; 209/417-419; 294/1.3, 1.4, 1.5, 19.1, 49, 51, 55, 55.5, 99.2; 119/1**

FIG. 3 is a left side elevational view thereof;

FIG. 4 is a right side elevational view thereof;

FIG. 5 is a top plan view thereof; and,

FIG. 6 is a bottom plan view thereof.

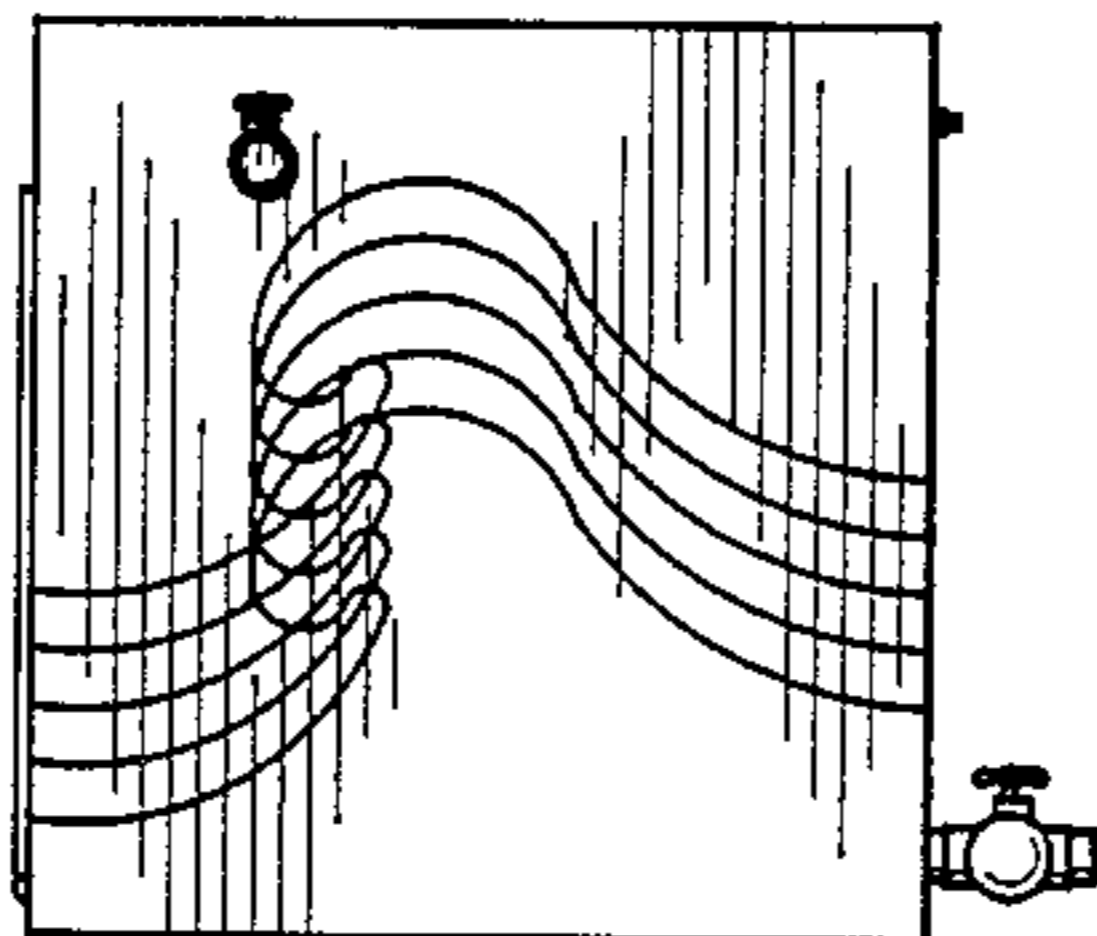
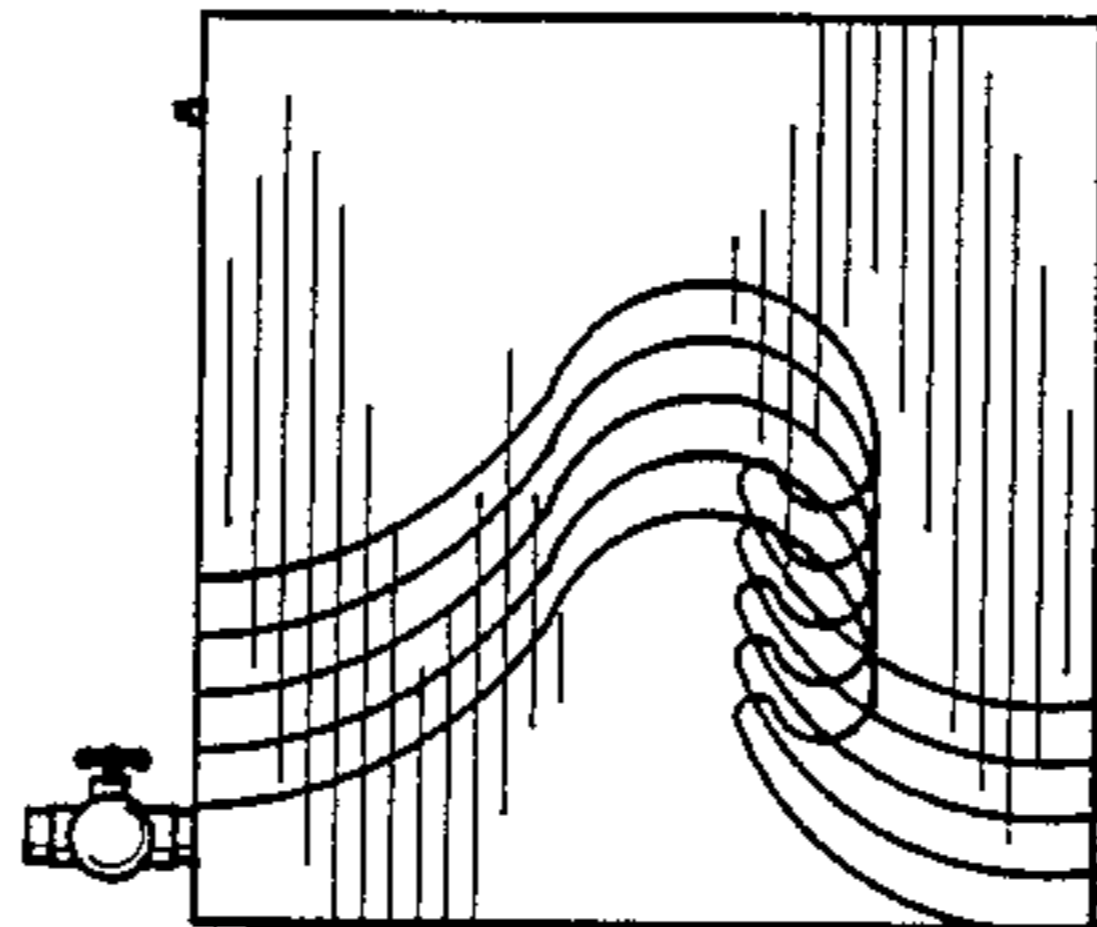

Fig. 1

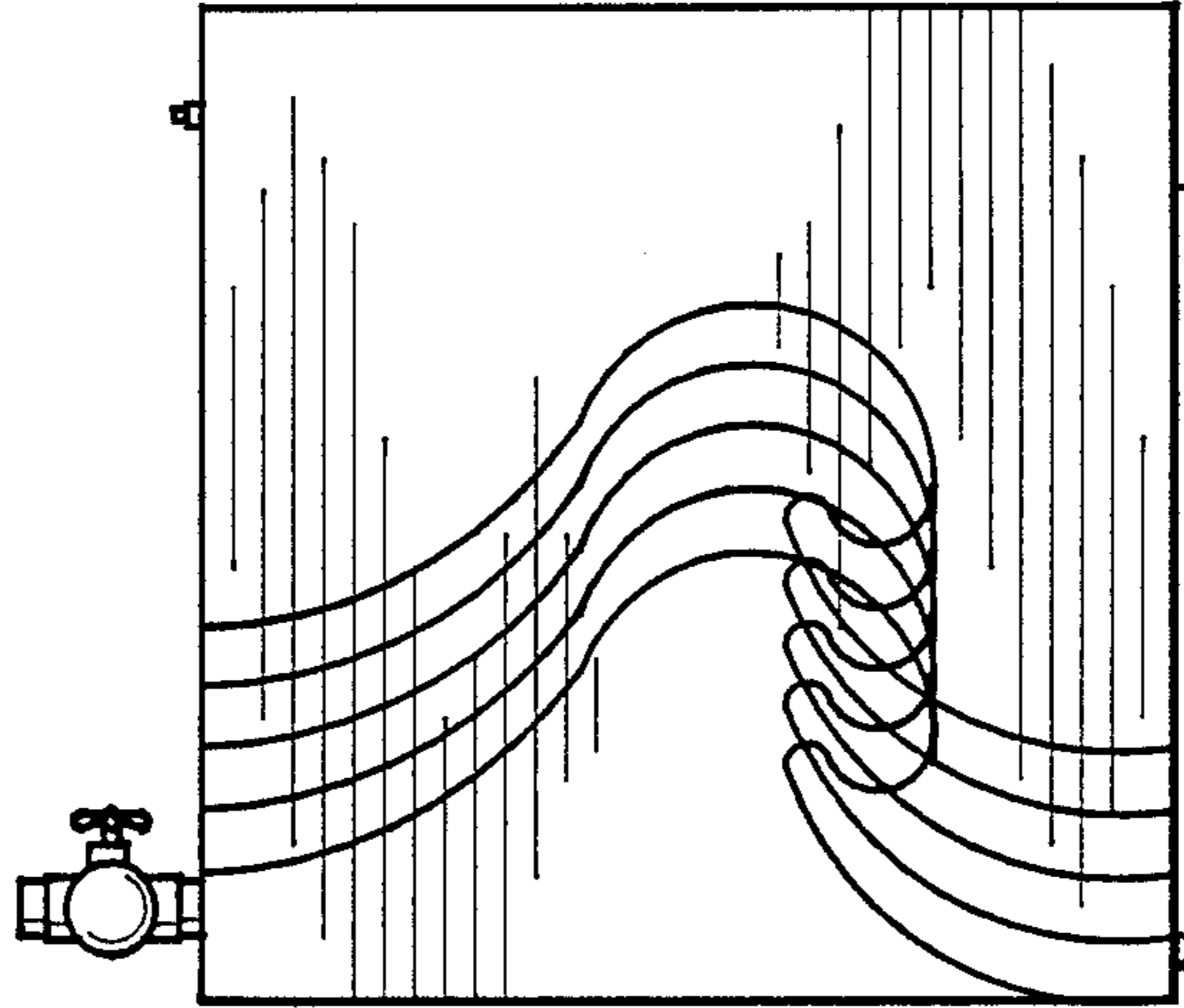

Fig. 2

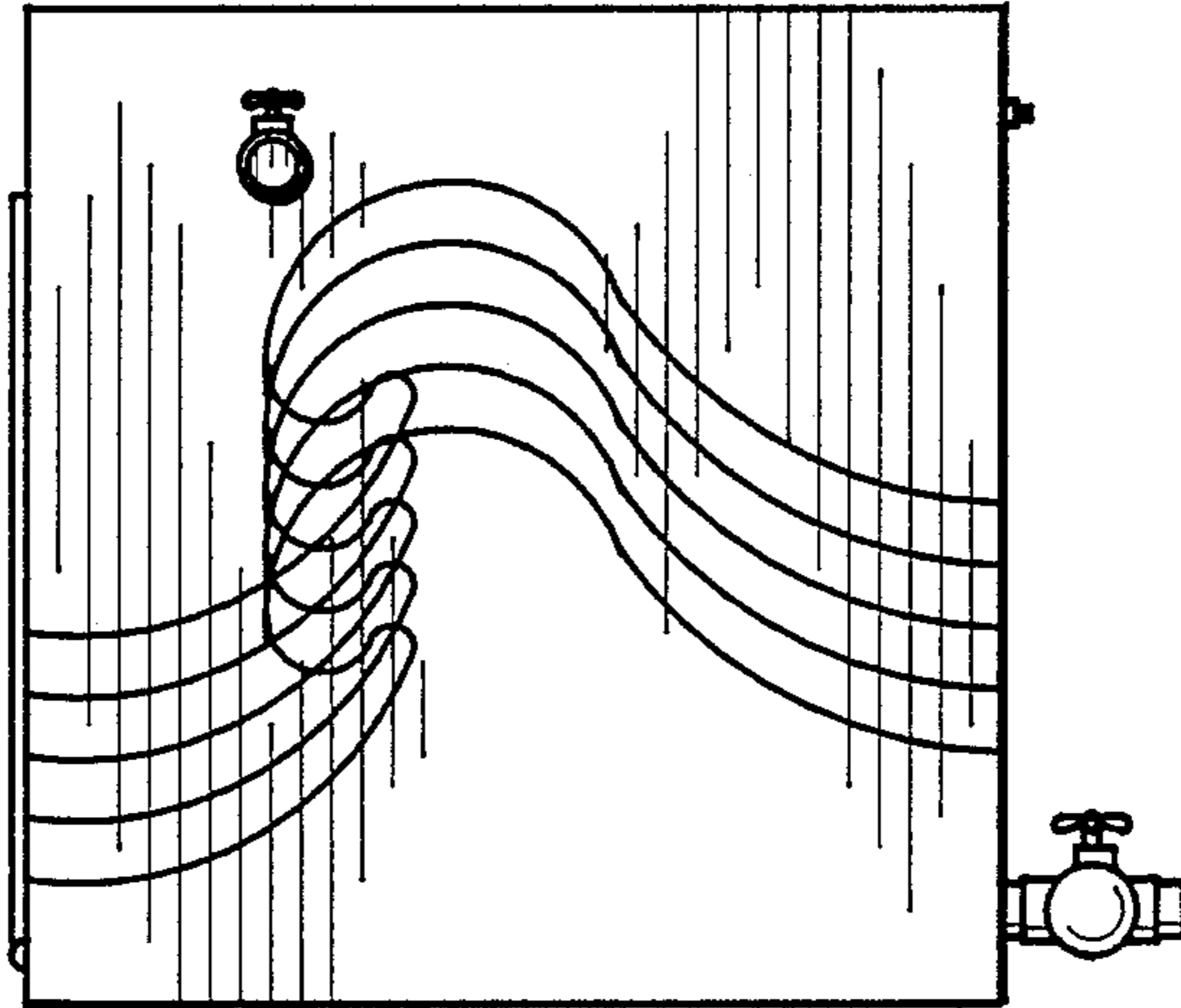

Fig. 3

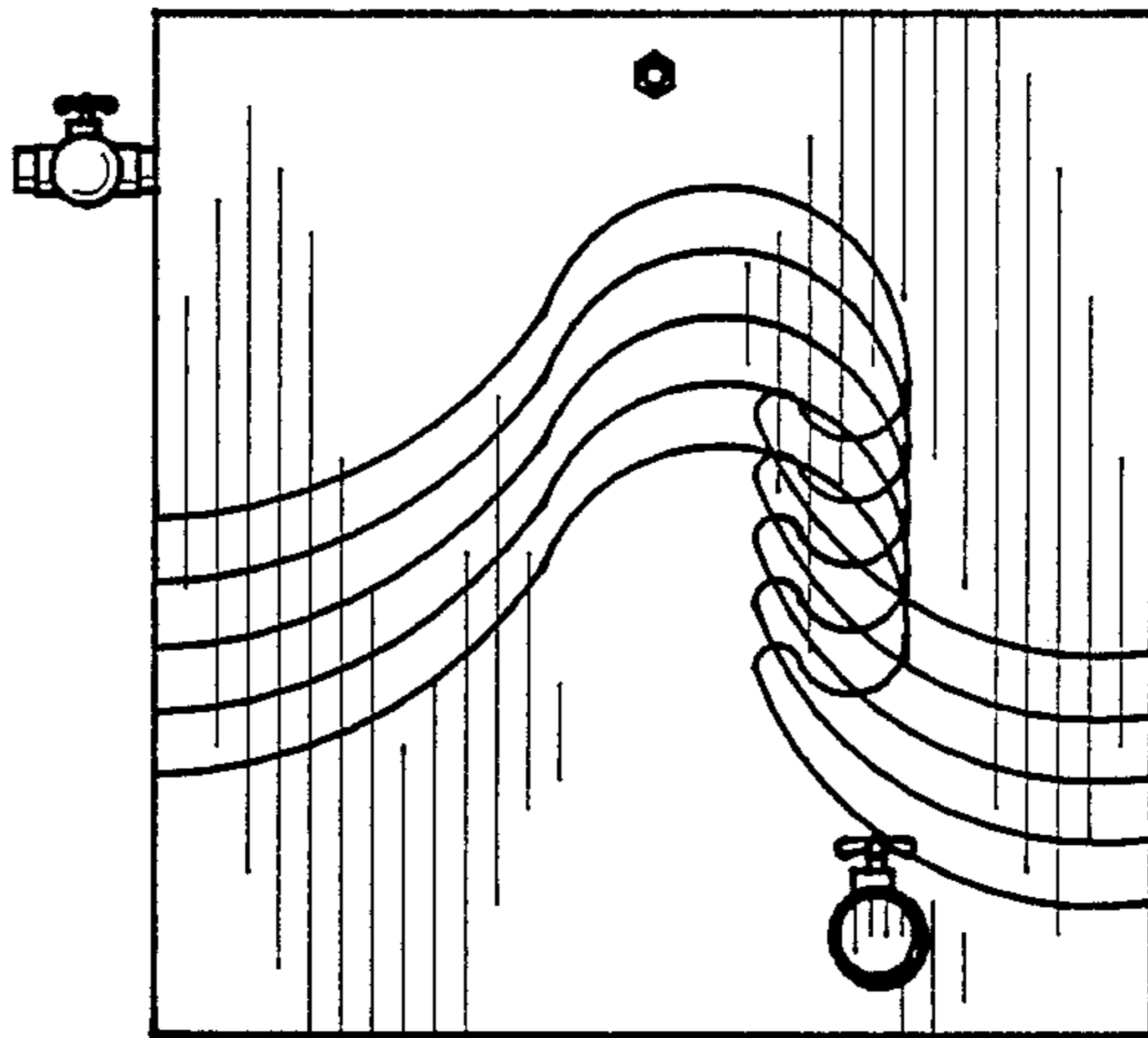

Fig. 4

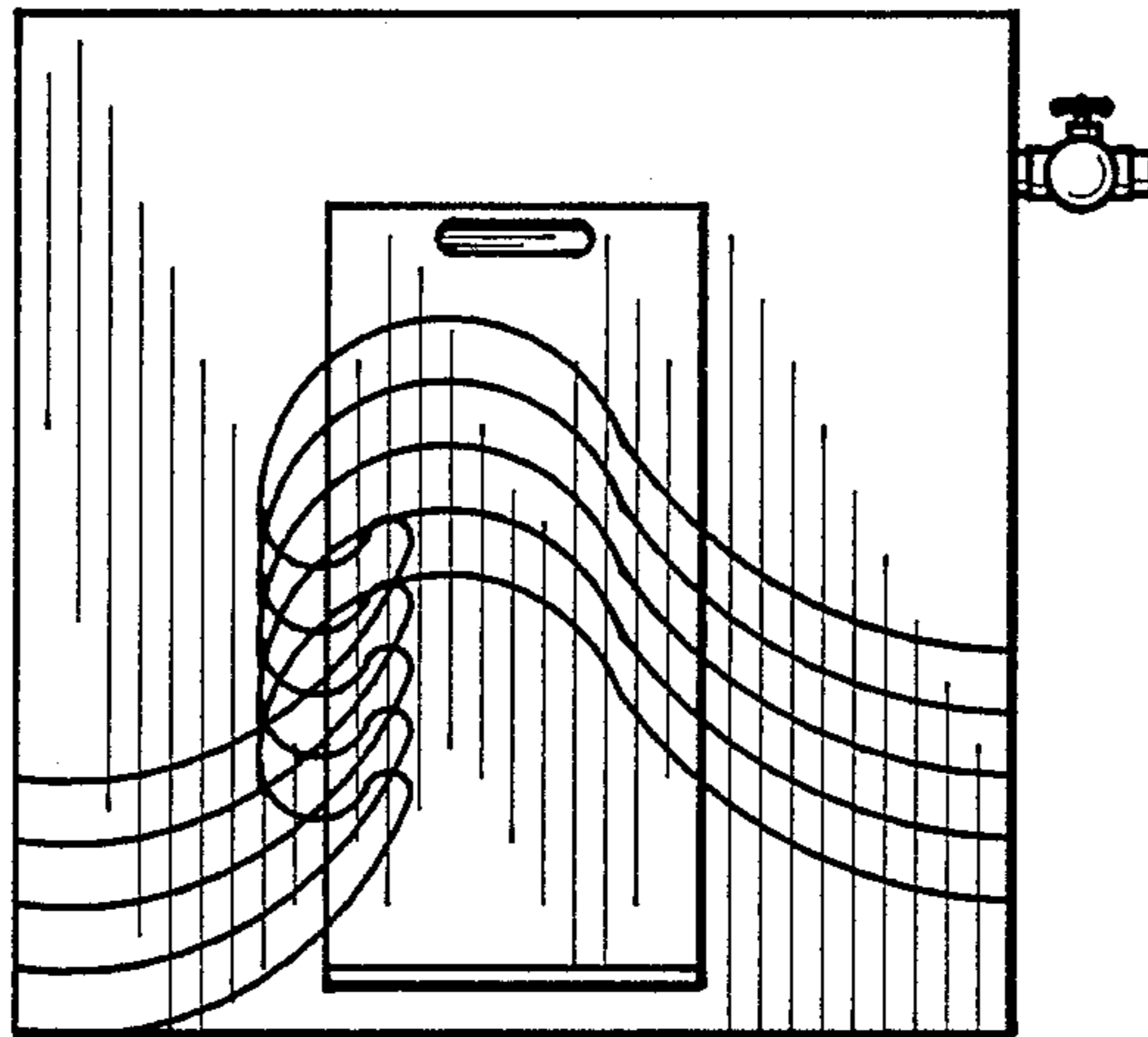

Fig. 5

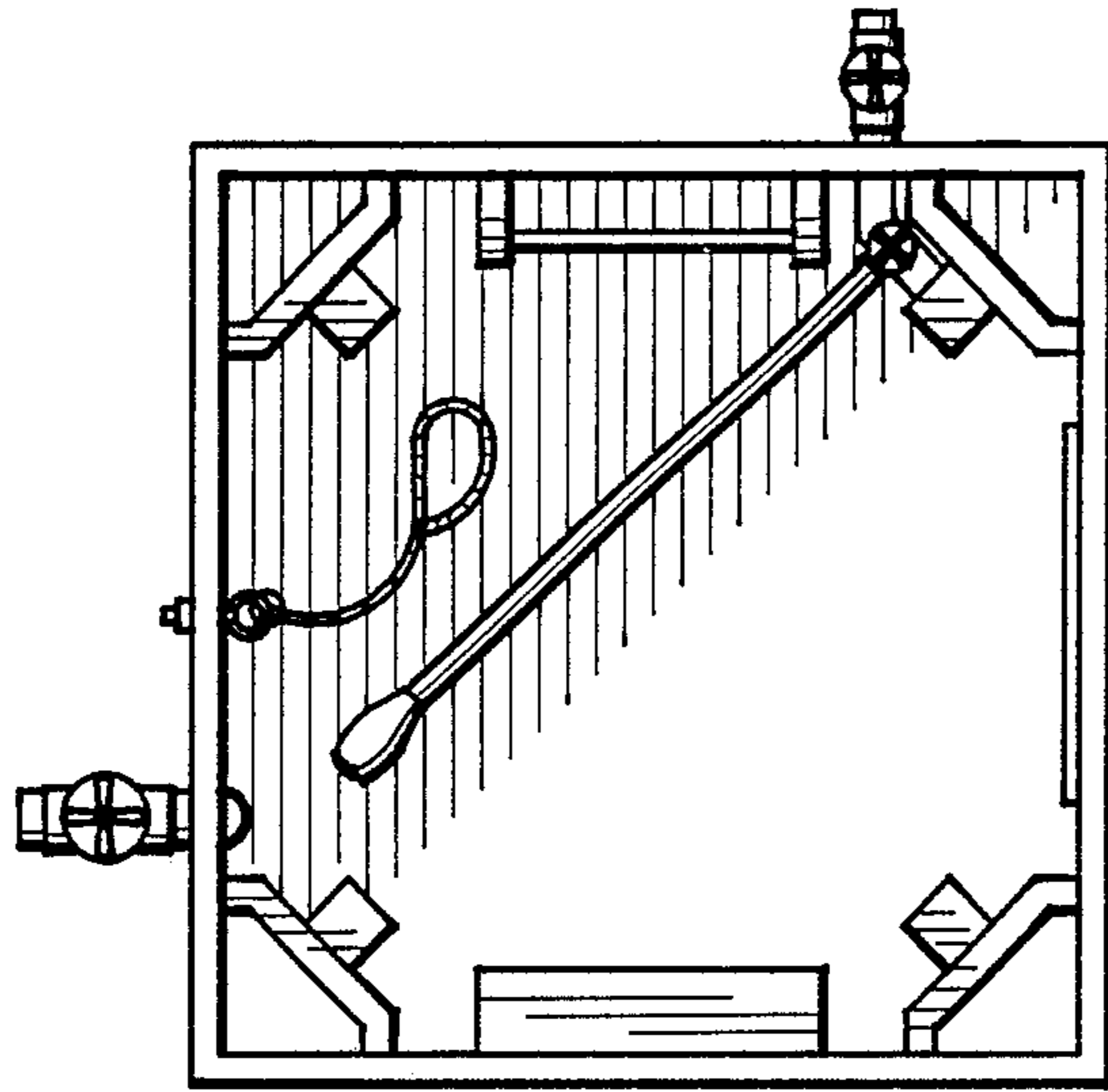

Fig. 6

