

[54] BATHTUB OR THE LIKE

[75] Inventors: Bruce M. Sauter, Kohler; Robert C. Giese, Sheboygan, both of Wis.

[73] Assignee: Kohler Co., Kohler, Wis.

[\*\*] Term: 14 Years

[21] Appl. No.: 2,255

[22] Filed: Jan. 12, 1987

[52] U.S. Cl. .... D23/277

[58] Field of Search ..... D23/270-283, D23/303-307; D24/38, 39; 4/513, 538-544, 546, 559, 571-579, 584, 589, 590

D. 285,600 9/1986 Steinhardt ..... D23/277  
D. 287,397 12/1986 Cuttriss ..... D23/281  
4,383,341 5/1983 Altman ..... 4/538 X

OTHER PUBLICATIONS

Two pages of a 1984 Aqua Glass ad entitled "Aqua Whirl".

Two pages of a Jacuzzi brochure, undated, admitted prior art, entitled "Jacuzzi-Whirlpool-System".

Primary Examiner—James R. Largen  
Attorney, Agent, or Firm—Quarles & Brady

CLAIM

[57] The ornamental design for a bathtub or the like, as shown and described.

DESCRIPTION

FIG. 1 is a top perspective view of a bathtub or the like showing our new design;

FIG. 2 is a top plan view thereof;

FIG. 3 is a cross sectional view taken along line 3—3 of FIG. 2;

FIG. 4 is a cross sectional view taken along line 4—4 of FIG. 2;

FIG. 5 is a cross sectional view taken along line 5—5 of FIG. 2; and

FIG. 6 is an enlarged cross sectional view taken along line 6—6 of FIG. 2.

The fragmentary broken line showing of a bathroom island in FIG. 1 and the broken line showing of whirlpool fitting holes in FIG. 3 are for purposes of illustration only and form no part of the claimed design.

[56] References Cited

U.S. PATENT DOCUMENTS

- D. 211,876 8/1968 Doman .
- D. 211,877 8/1968 Doman .
- D. 227,100 6/1973 Weiss ..... D23/277
- D. 230,851 3/1974 Chisholm ..... D23/277
- D. 237,616 11/1975 Gordon ..... D23/277
- D. 238,071 12/1975 Ganger ..... D23/277
- D. 241,643 9/1976 Bonsack ..... D23/281
- D. 244,855 6/1977 Doman .
- D. 251,201 2/1979 Mathis ..... D23/277
- D. 251,920 5/1979 Ogden ..... D24/38
- D. 254,206 2/1980 Ogden ..... D23/277
- D. 255,262 6/1980 Beddome et al. .... D23/281
- D. 270,760 9/1983 Wiley ..... D23/277
- D. 274,454 6/1984 Robinson ..... D23/281
- D. 274,835 7/1984 Gruber ..... D23/281
- D. 279,028 5/1985 Kohler, Jr. et al. .

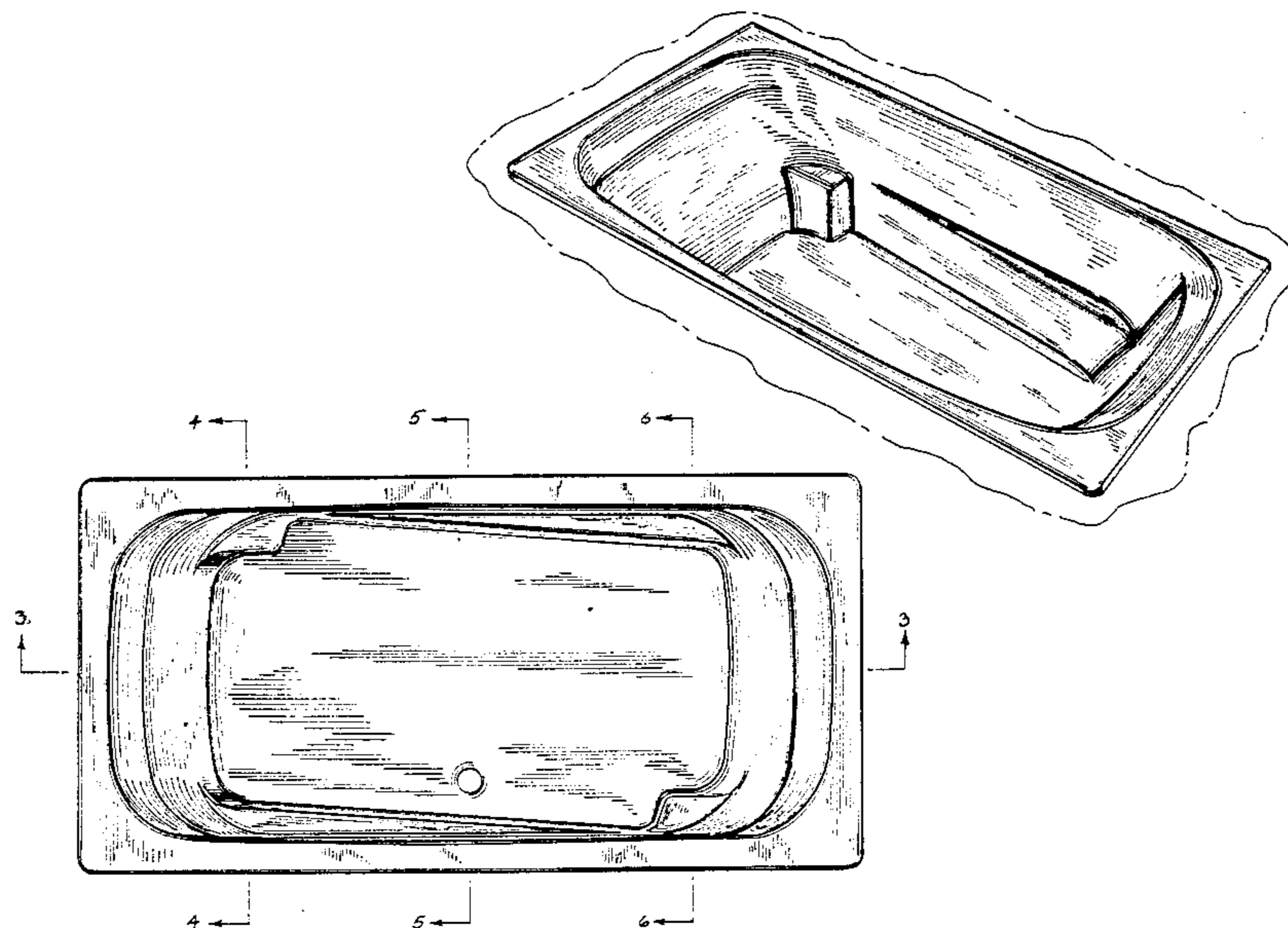

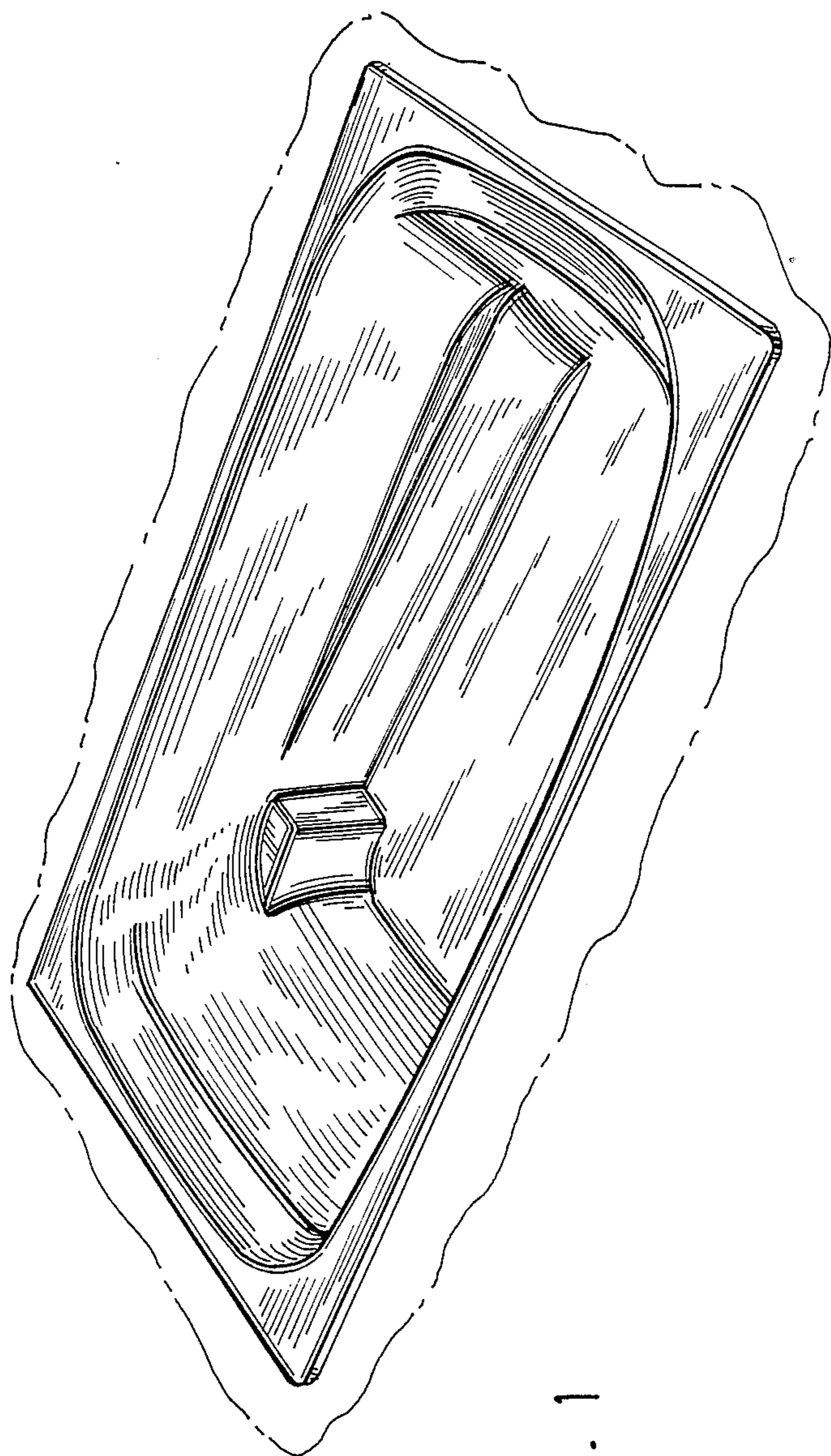

FIG. 1

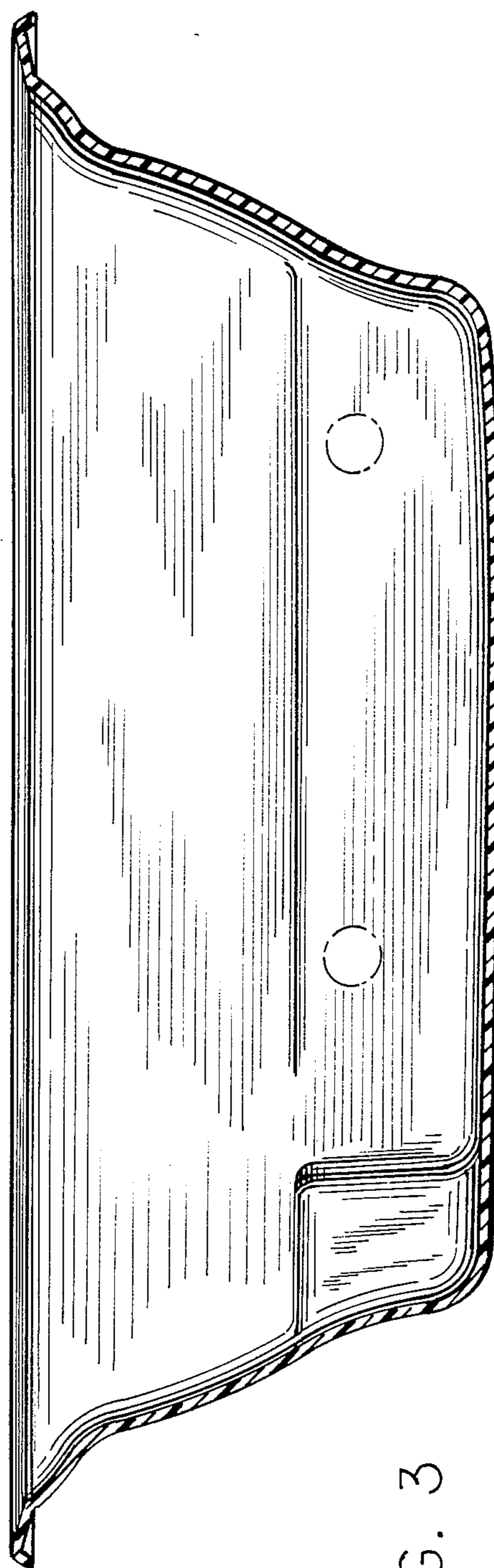

FIG. 3

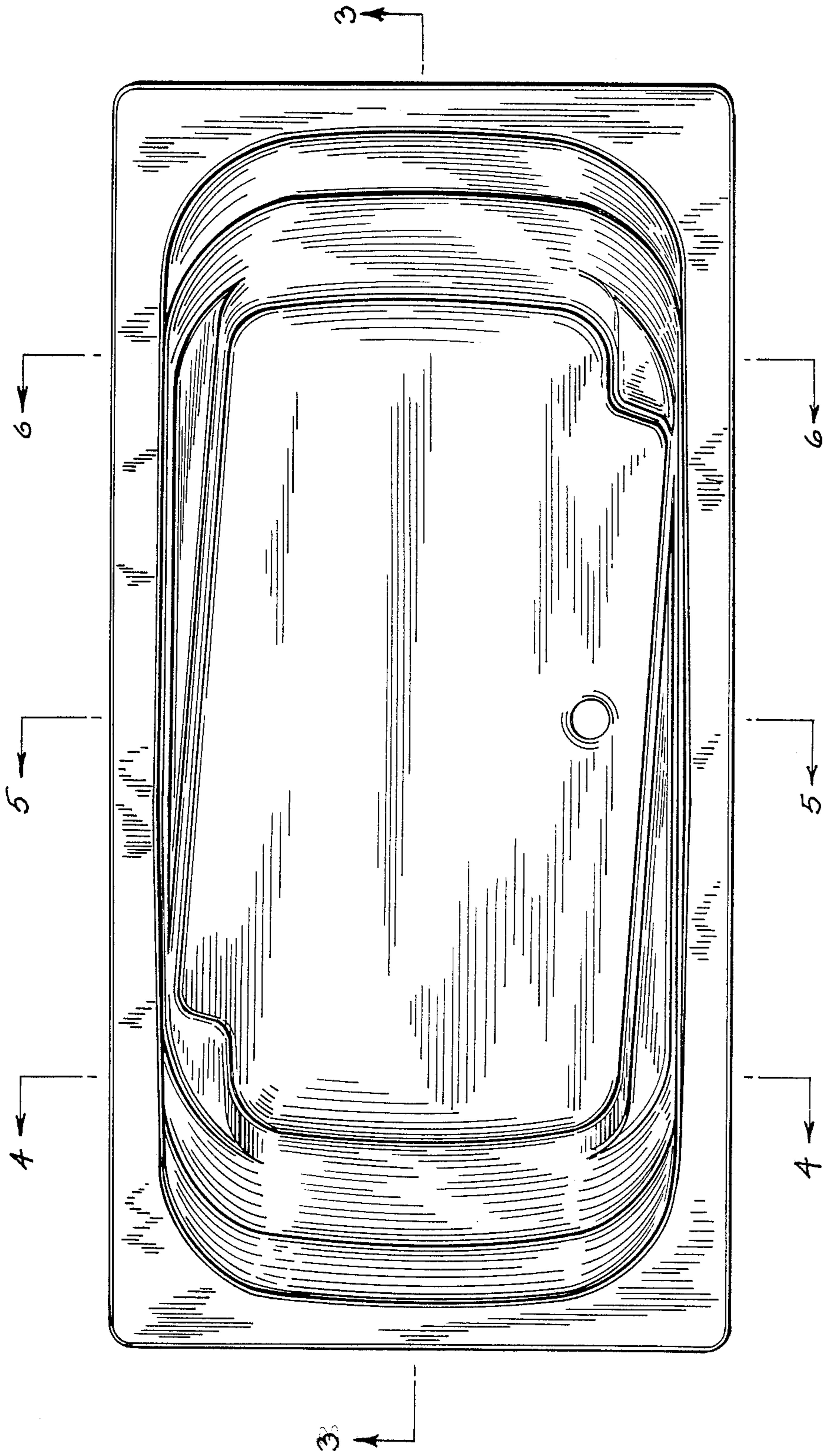

FIG. 2

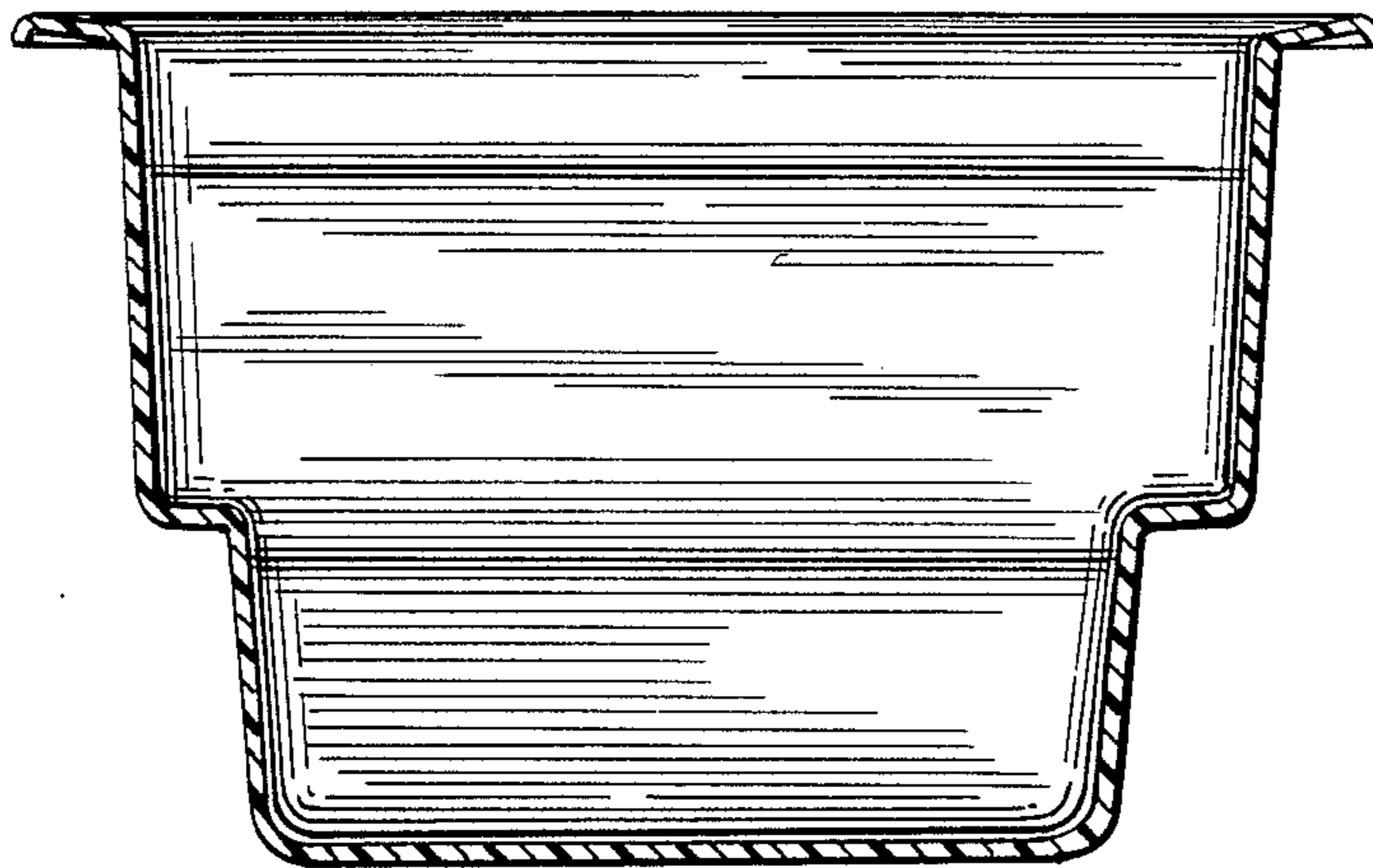

FIG. 4

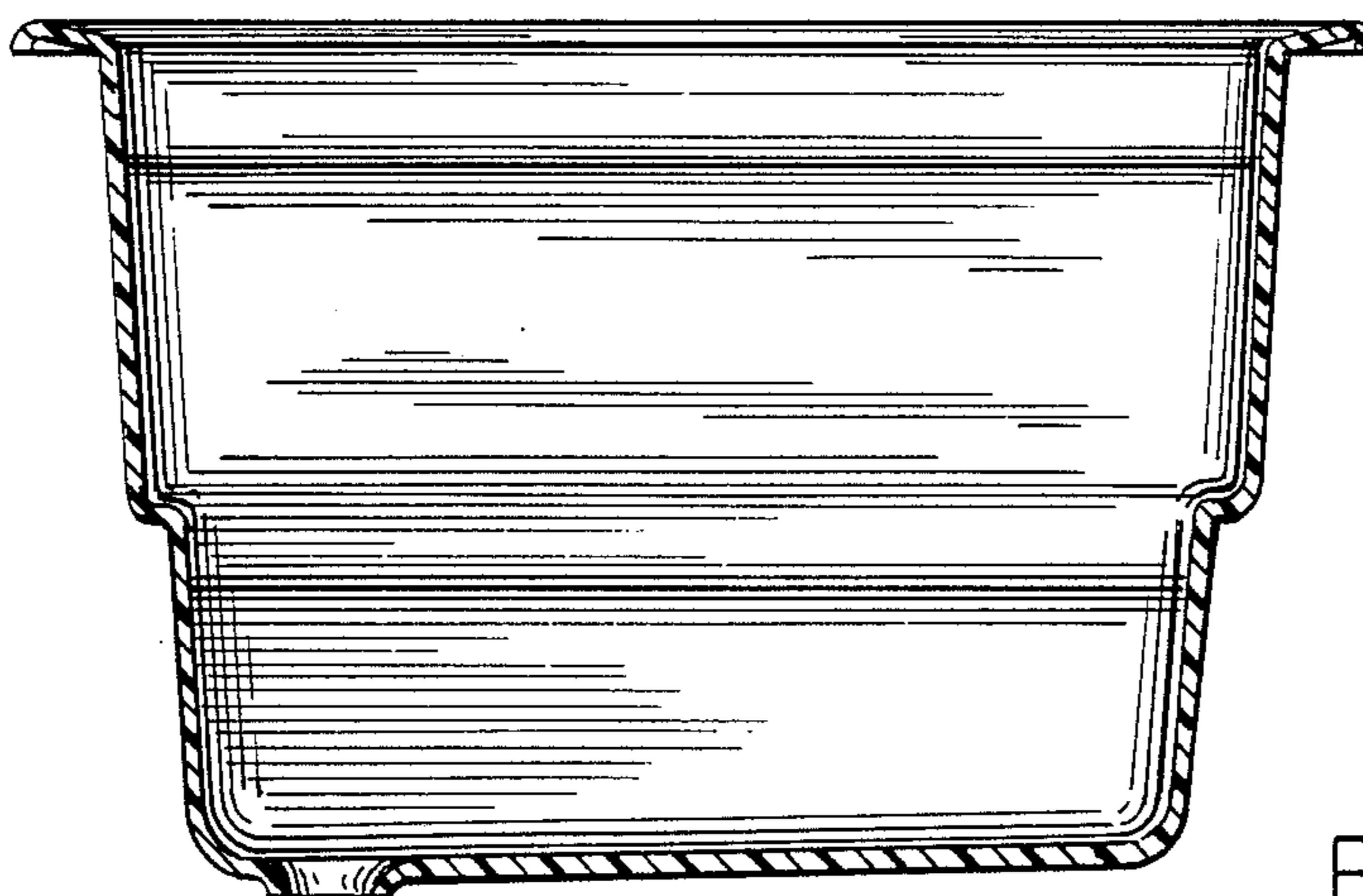

FIG. 5

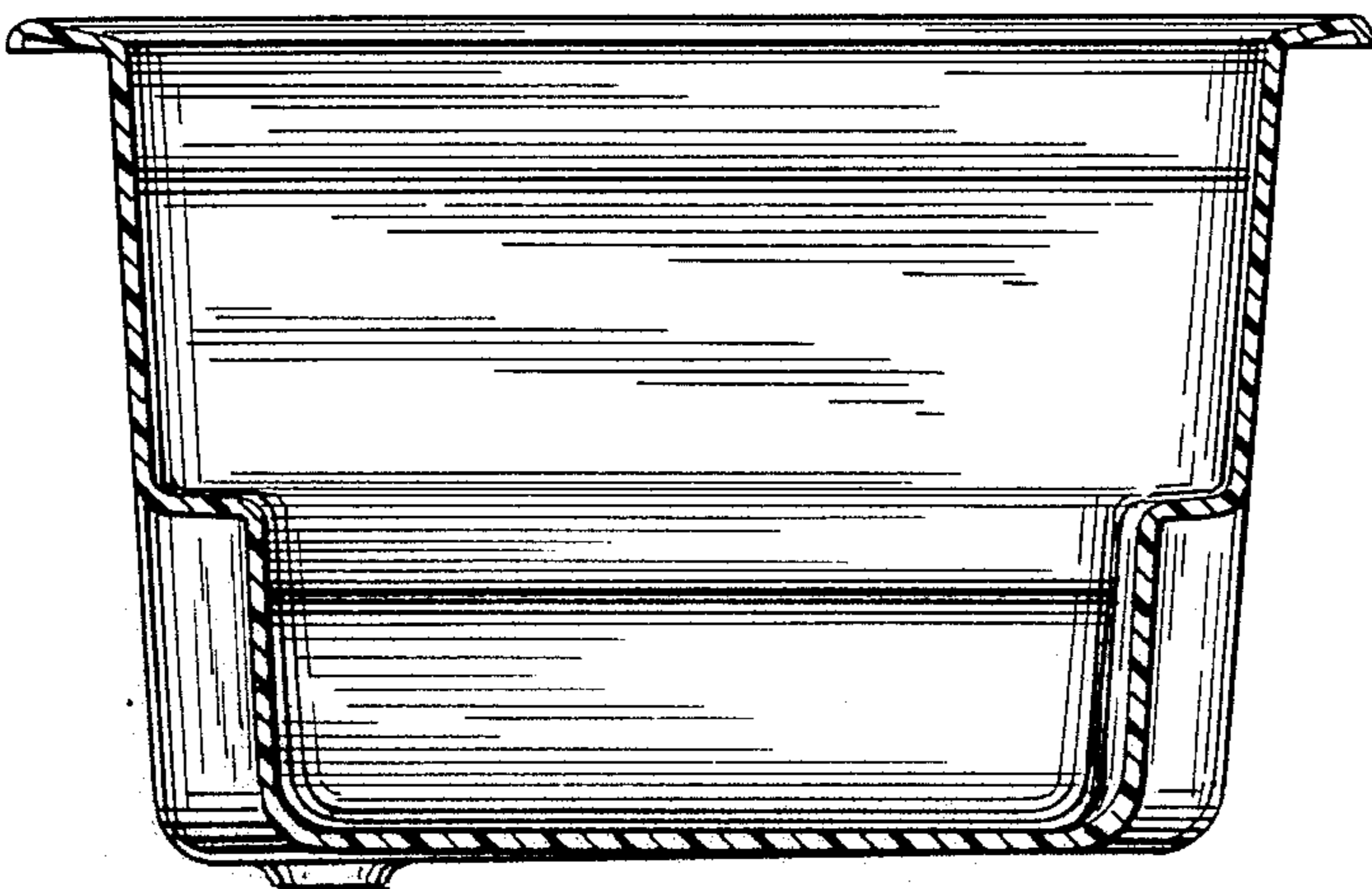

FIG. 6