

[54] COMBINED SHEET FEEDER AND EDITING DEVICE FOR A COPYING MACHINE

[75] Inventors: Minoru Aoyama, Tokyo; Tomohiko Hirata, Kanagawa, both of Japan

[73] Assignee: Canon Kabushiki Kaisha, Tokyo, Japan

[**] Term: 14 Years

[21] Appl. No.: 260,491

[22] Filed: Oct. 21, 1988

[30] Foreign Application Priority Data

Apr. 25, 1988 [JP] Japan 63-17019

[52] U.S. Cl. D18/42; D18/40

[58] Field of Search D18/36-44; 271/3, 3.1, 8.1, 9; 355/200, 308, 309, 244, 323; 358/498

[56] References Cited

U.S. PATENT DOCUMENTS

- D. 265,655 8/1982 Goto D18/38
- D. 270,538 9/1983 Yasutani D18/38
- D. 292,408 10/1987 Harrison D18/39
- 4,712,908 12/1987 Nakayama et al. 355/244

FOREIGN PATENT DOCUMENTS

- 0111171 6/1984 Japan 355/323
- 0009370 1/1987 Japan 355/323

Primary Examiner—Nelson C. Holtje
Assistant Examiner—Caron D. Veynar
Attorney, Agent, or Firm—Fitzpatrick, Cella, Harper & Scinto

[57] CLAIM

The ornamental design for an combined sheet feeder and editing device for a copying machine, as shown and described.

DESCRIPTION

FIG. 1 is a front elevational view of an combined sheet feeder and editing device for a copying machine showing our new design;
FIG. 2 is a rear elevational view thereof;
FIG. 3 is a top plan view thereof;
FIG. 4 is a bottom plan view thereof;
FIG. 5 is a left side elevational view thereof;
FIG. 6 is a right side elevational view thereof;
FIG. 7 is a right front perspective view thereof, the broken line showing of a photocopier is environmental only and forms no part of the claimed design.

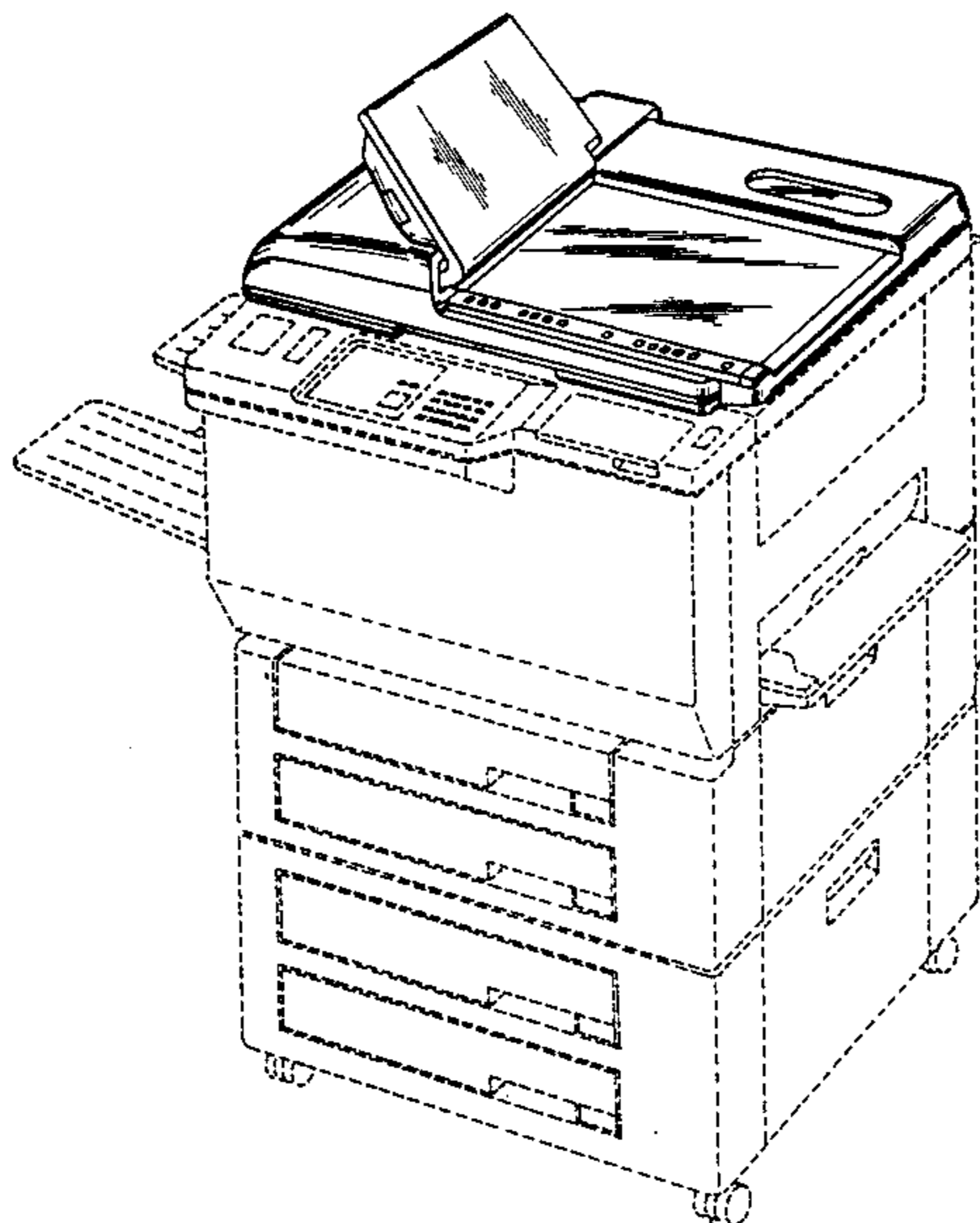

FIG. 1

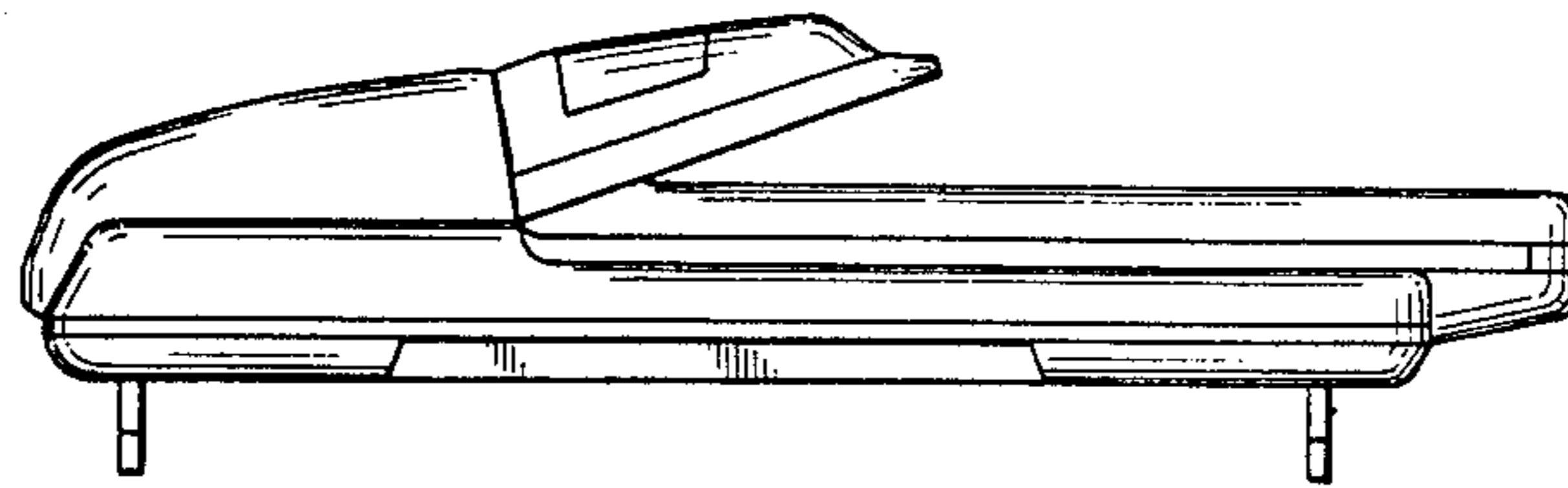

FIG. 2

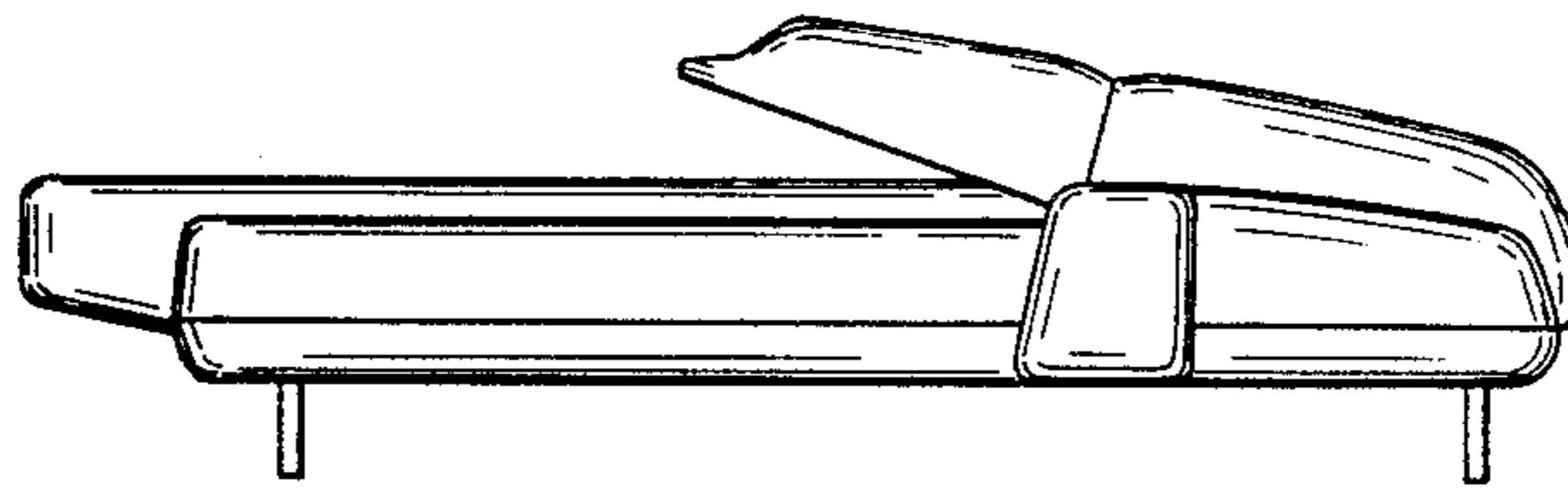

FIG. 3

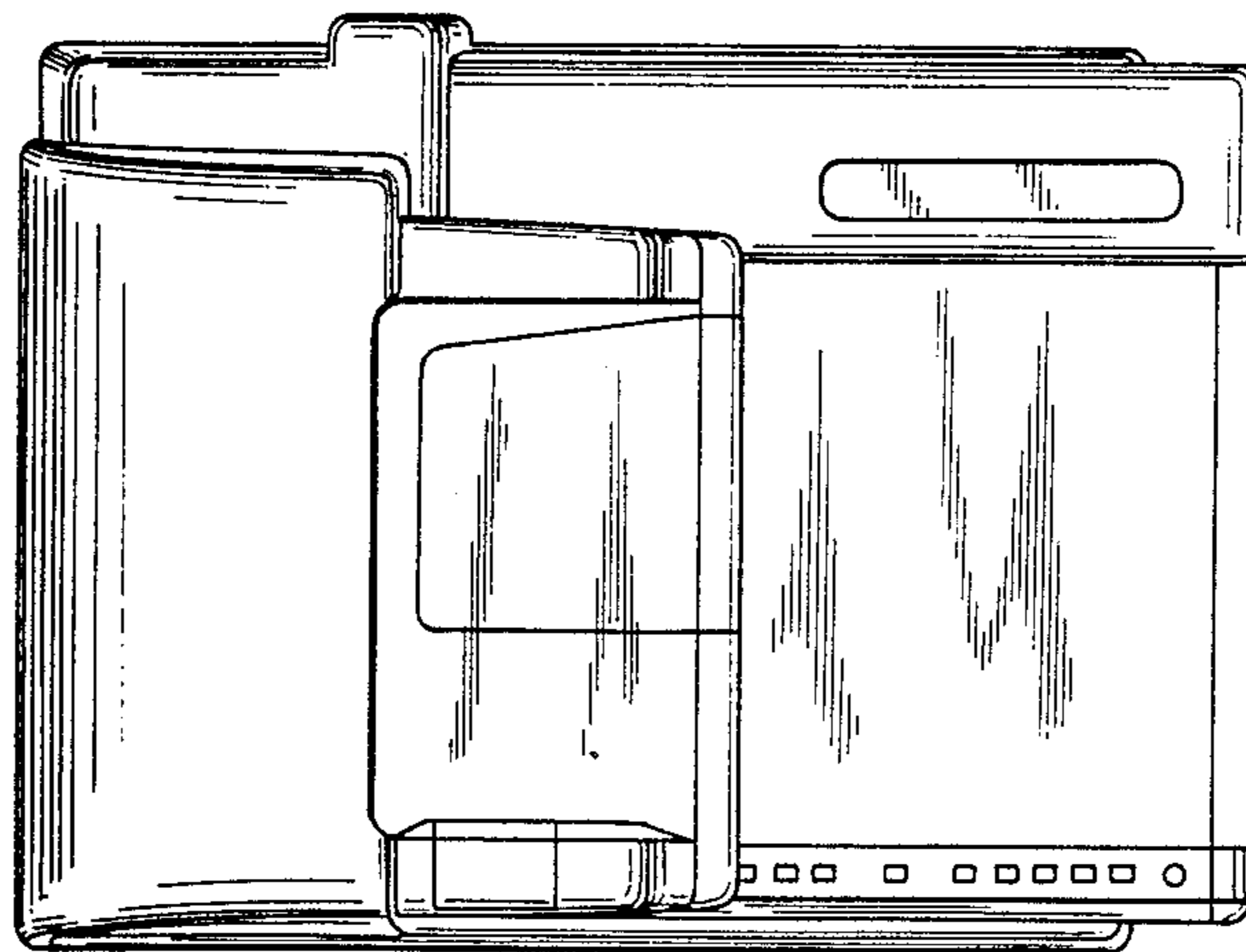

FIG. 4

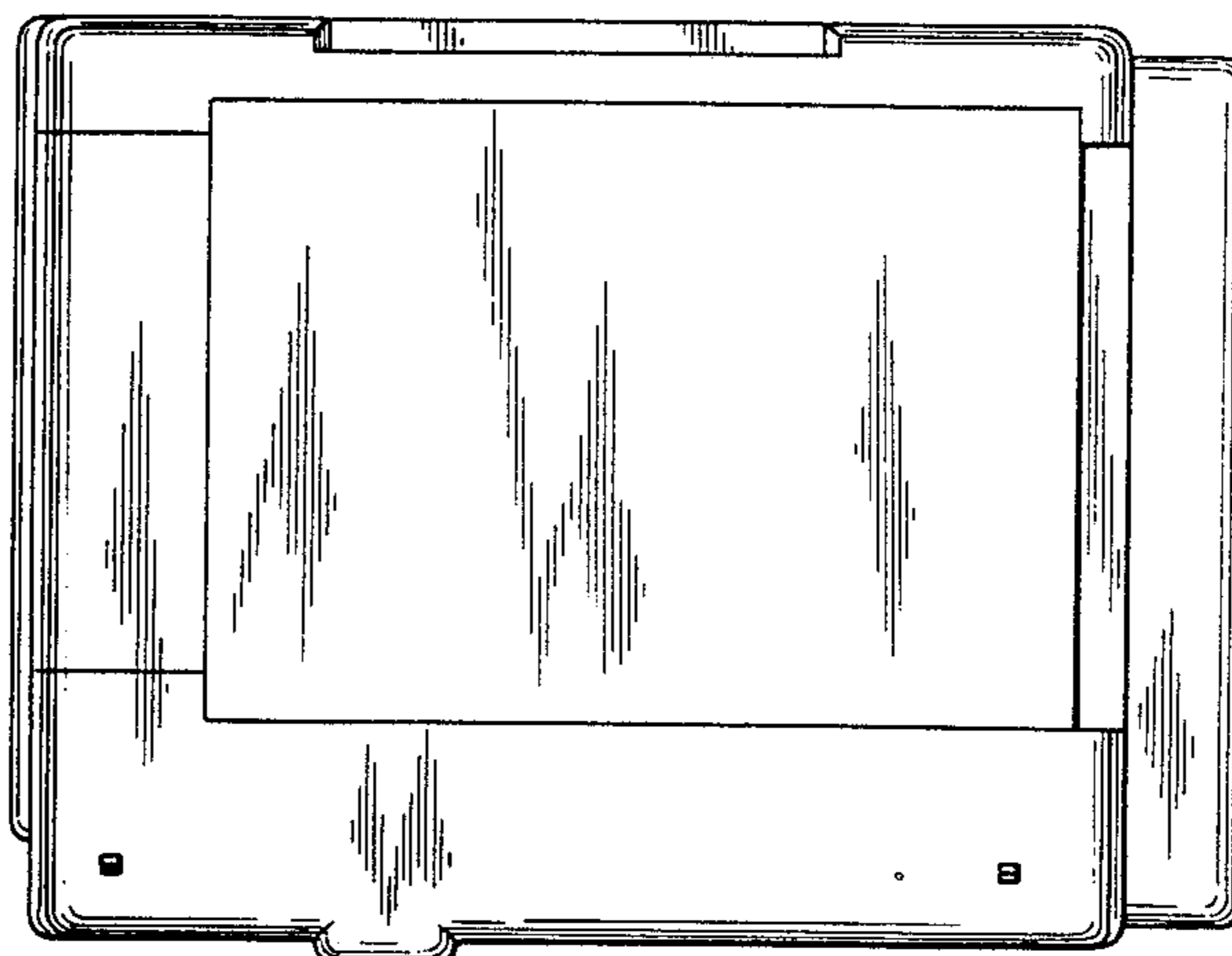

FIG. 5

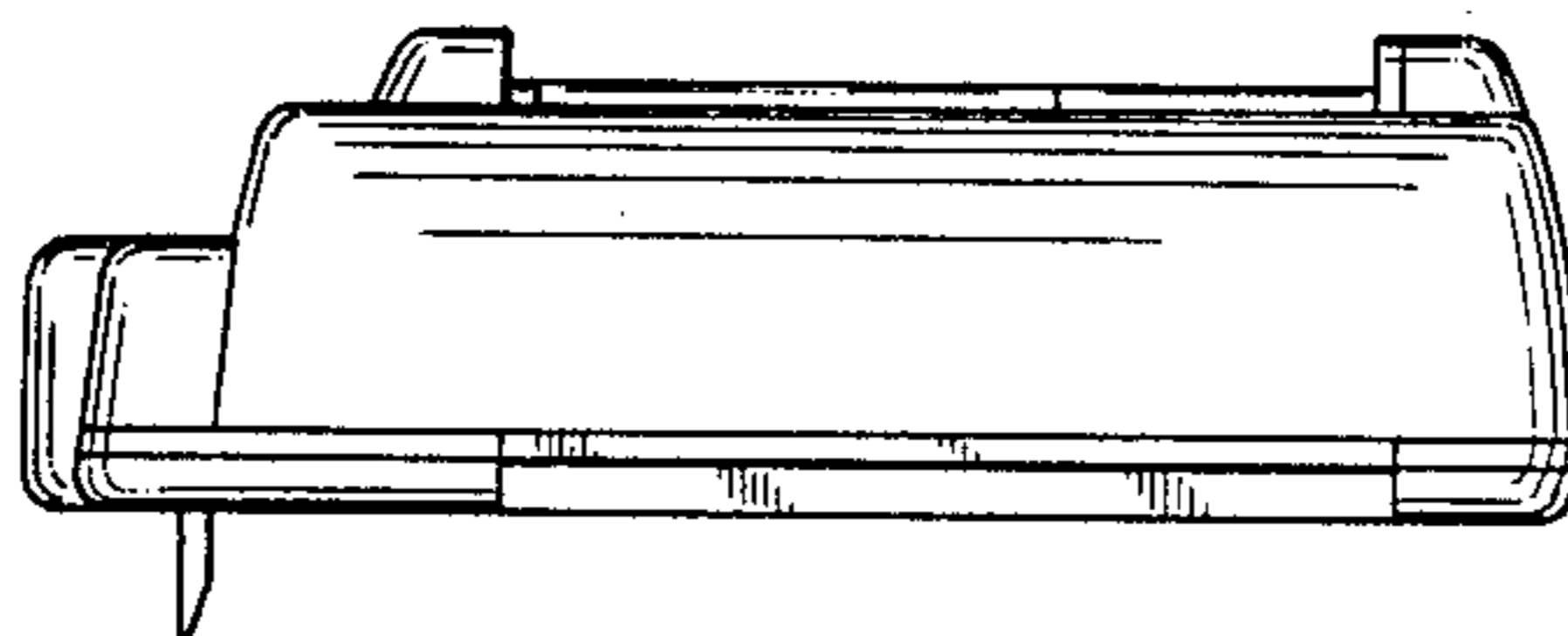

FIG. 6

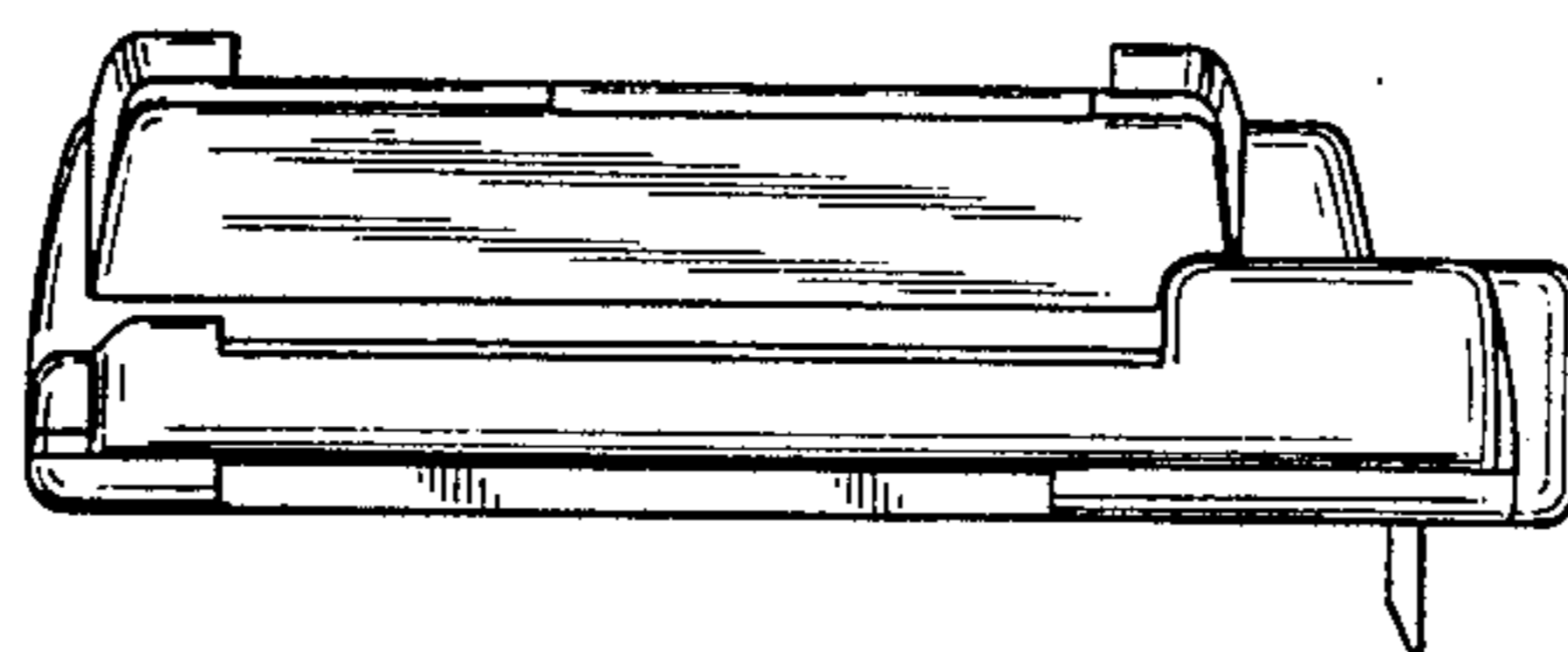

FIG. 7

